

# Operations & Maintenance Manual



**SUTRON XLINK 100/500**  
**Part No. 8800-1217 Rev 8.44.2**  
**July 28, 2022**

# TABLE OF CONTENTS

<b>1</b>	<b>Scope of Supply.....</b>	<b>9</b>
1.1	Ordering Numbers .....	10
<b>2</b>	<b>General Safety Information.....</b>	<b>12</b>
2.1	English .....	12
2.2	French .....	15
<b>3</b>	<b>Symbols used in the manual .....</b>	<b>18</b>
<b>4</b>	<b>Introduction.....</b>	<b>19</b>
4.1	XLink 500 .....	20
4.2	XLink 100 .....	21
4.3	Multi-function Button .....	22
4.4	Status LEDs .....	22
4.5	RS-232 .....	23
4.6	USB Micro (OTG) .....	23
4.7	USB Host.....	23
4.8	XLINK-500 and XLINK-100 Left Terminal strip .....	24
4.9	XLINK-500 Right Terminal Strip .....	25
<b>5</b>	<b>Installing XLink.....</b>	<b>26</b>
5.1	Attaching XLink 500 and 100.....	26
5.2	Installing Option Cards .....	27
5.3	Earth Ground Point .....	30
5.4	Connecting the Power Supply .....	31
5.5	Connecting SDI-12 sensors.....	33
5.6	Connecting RS-485 Sensors.....	33
5.7	Connecting Tipping Bucket Rain Gauge .....	34
5.8	Connecting Pulse Sensors .....	35



5.9	Connecting Frequency Sensors .....	36
5.10	Connecting 0-5V Analog Sensors .....	36
5.11	Connecting 4-20ma Analog Sensors.....	37
5.12	Connecting Status Sensors .....	38
5.13	Connecting Potentiometer Sensors .....	38
5.14	Connecting mV Sensors.....	39
5.15	Connecting Thermistors .....	39
5.16	Connecting Thermocouples .....	41
5.17	Connecting Strain Gauges .....	43
5.18	Programmable Excitation References .....	43
5.19	Connecting Prop/Vane or Anemometer/Vane Wind Sensors.....	44
5.20	Connecting Lufft Wind Sensors .....	45
5.21	Connecting Digital Outputs .....	46
5.22	Connecting Samplers Triggered by Stage.....	46
5.23	Connecting to the Switched Power .....	46
5.24	Connecting Protected Power .....	47
5.25	Connecting External Modems .....	47
5.26	Connecting External Cell Modems .....	48
5.27	Inserting an SD card .....	49
<b>6</b>	<b>Installing and Running LinkComm .....</b>	<b>50</b>
6.1	Installing the LinkComm mobile app.....	50
6.2	Installing the PC version of LinkComm .....	50
6.3	Stations List View .....	50
6.4	Main Menu .....	56
6.5	Station View .....	57
6.6	Dashboard Tab .....	61
6.7	Measurements Tab .....	63



6.8	Data Tab .....	64
6.9	Telemetry Tab .....	65
6.10	Scripts Tab .....	66
6.11	Other Setup Tab .....	68
6.12	Diagnostics Tab .....	69
6.13	Password Menu.....	71
6.14	Quick Status Dialog .....	72
<b>7</b>	<b>Operating XLink .....</b>	<b>74</b>
7.1	Creating a New Station in LinkComm.....	74
7.2	Connecting to a station in Your Station List .....	74
7.3	Importing Setups From Another User Or Station .....	74
7.4	Testing Measurements.....	74
7.5	Examine Measurements.....	75
7.6	Examine Transmissions .....	75
7.7	Examine Transmission Data .....	75
7.8	Entering Manual Data .....	75
7.9	Calibrating Sensors.....	75
7.10	Configuring SDI-12 Sensors .....	75
7.11	Downloading Log Data .....	76
7.12	Viewing/Clearing the Status.....	76
7.13	Software Version.....	76
7.14	Setting Time .....	77
7.15	USB Thumb Drive (Flash Drive) Operation .....	78
7.16	SD Card Operation.....	82
<b>8</b>	<b>Security.....</b>	<b>86</b>
8.1	Steps to Take to Protect your Station .....	86
8.2	Password Protection .....	86



<b>9</b>	<b>Setup</b>	<b>89</b>
<b>10</b>	<b>Measurement Setup</b>	<b>90</b>
10.1	Sensor Setup	90
10.2	Schedule	93
10.3	Configuration Settings	97
10.4	Processing Settings	113
10.5	Alarm Settings	116
10.6	Alarm Computation Details	119
10.7	Logging Settings	120
10.8	Transmission Data Content Settings	121
10.9	Measurement Setup Defaults	123
10.10	Measurement Calibration	123
10.11	Multiple Measurements Using the Same Sensor	124
<b>11</b>	<b>Telemetry Setup</b>	<b>125</b>
11.2	Cell Setup	127
11.3	Iridium Setup	134
11.4	Additional Telemetry Settings	136
11.5	Telemetry Status	138
<b>12</b>	<b>Other Setup</b>	<b>140</b>
12.1	Wi-Fi	140
12.2	Log Daily Values	141
12.3	Digital Output	141
12.4	Cutoff	143
12.5	Iridium	145
12.6	Cell	145
12.7	Time	145
12.8	Log Download Format	145



12.9	Modbus .....	149
12.10	General Purpose Variables .....	149
<b>13</b>	<b>Telemetry .....</b>	<b>151</b>
13.1	Iridium Telemetry.....	151
13.2	Cellular Telemetry .....	154
13.3	Missing Data Retrieval.....	159
13.4	Retransmissions .....	161
13.5	File Transmissions .....	162
<b>14</b>	<b>Logging .....</b>	<b>163</b>
14.1	Downloading the Log .....	163
14.2	Log Events .....	164
14.3	Logged Time .....	164
<b>15</b>	<b>Errors .....</b>	<b>166</b>
15.1	Clearing Errors.....	166
15.2	Measurement Errors .....	166
15.3	System Errors .....	167
<b>16</b>	<b>Transmission Data Formats.....</b>	<b>169</b>
16.1	Pseudobinary B Data Format .....	169
16.2	Pseudobinary C Data Format .....	171
16.3	Pseudobinary D Data Format .....	173
16.4	Six Bit Binary Encoded Format .....	175
16.5	Pseudobinary over SMS .....	176
16.6	SHEF and SHEFFIX Data Format.....	177
16.7	Sutron Standard CSV .....	179
16.8	MIS .....	179
16.9	ASCII Column .....	180
16.10	ASCII Sensor .....	180

16.11 TCP/IP Session .....	181
16.12 Iridium Telemetry Header .....	183
<b>17 Command Line Interface .....</b>	<b>186</b>
17.1 Why Use Command Line? .....	186
17.2 About the Command Line Interface .....	186
17.3 Status .....	187
17.4 Setup .....	187
17.5 Measurements .....	189
17.6 Recording .....	189
17.7 Downloading the Log .....	189
17.8 Machine-to-Machine Communication .....	191
17.9 Command Reference .....	191
<b>18 More about SDI-12 .....</b>	<b>199</b>
18.1 Overview .....	199
18.2 Wiring Guidelines .....	200
18.3 Connector .....	200
18.4 Setup of SDI sensors .....	200
18.5 Useful SDI commands .....	201
18.6 SDI Clock Synchronization .....	201
<b>19 Modbus .....</b>	<b>203</b>
19.2 Modbus Hardware Interface .....	204
19.3 Modbus Setup .....	205
19.4 Modbus Server Function Codes .....	209
19.5 Sutron Function Codes .....	212
<b>20 Scripts .....</b>	<b>217</b>
20.1 Measurements and Scripts .....	217
20.2 Transmission Formatting and Scripts .....	220



20.3	Script Tasks.....	221
20.4	Scripts Management .....	224
20.5	LinkComm Command Line Options.....	225
<b>21</b>	<b>Appendix A – Specifications .....</b>	<b>227</b>
<b>22</b>	<b>Appendix B – Sutron Customer Service Policy .....</b>	<b>230</b>
<b>23</b>	<b>Appendix C – Commercial Warranty .....</b>	<b>231</b>
23.1	Sutron Manufactured Equipment .....	231
23.2	Non-Sutron Manufactured Equipment .....	231
23.3	Repair and Return Policy .....	232
<b>24</b>	<b>Appendix E – Approvals and Certifications.....</b>	<b>233</b>
24.1	CE .....	233
24.2	Wi-Fi Module.....	233
24.3	IRIDIUM .....	234
24.4	Cellular Compliance Information .....	235
24.5	Notice .....	236
<b>25</b>	<b>Appendix F - SIM Card Installation and Removal Instructions .....</b>	<b>237</b>
<b>26</b>	<b>Appendix G – Additional Safety, Installation, and Maintenance Instructions.....</b>	<b>241</b>
26.1	Instructions for devices supplied without housing* .....	241
26.2	Instructions for devices supplied with NEMA enclosure <sup>1,2</sup> .....	244



# 1 Scope of Supply

<p>XLink 100</p>	<p>Site controller with the ability to collect, record, and transmit sensor data. Includes the following:</p> <ul style="list-style-type: none"> <li>▶ Power supply connection</li> <li>▶ Earth ground connection</li> <li>▶ RS-485 port</li> <li>▶ One isolated switching power supply</li> <li>▶ Two digital inputs</li> <li>▶ One switched open collector output</li> <li>▶ SDI-12 port for connecting to sensors</li> <li>▶ USB host for thumb drives</li> <li>▶ USB device for connecting to a PC</li> <li>▶ RS-232 port</li> <li>▶ Wi-Fi hotspot for connecting to LinkComm</li> <li>▶ One million reading log capacity</li> <li>▶ Two status LEDs</li> <li>▶ One multifunction button with LED</li> <li>▶ One option port for connecting to optional modems               <ul style="list-style-type: none"> <li>▲ Optional cellular modem</li> <li>▲ Optional Iridium modem</li> </ul> </li> <li>▶ 1 quick start guide</li> </ul>
<p>XLink 500</p>	<p>Provides all the features of XLink 100, plus the following:</p> <ul style="list-style-type: none"> <li>▶ Internal Solar Regulator</li> <li>▶ Two 0-5V analog inputs</li> <li>▶ Two differential analog inputs</li> <li>▶ One 4-20mA analog input</li> <li>▶ Two switching 2.5V reference voltage outputs</li> <li>▶ One isolated non-switching power supply</li> </ul>



## 1.1 Ordering Numbers

Part #	Description
<b>Basic (Logger only)</b>	
XLINK100-1	XLINK 100 no modem
XLINK100-1E	XLINK 100 no modem, NEMA 4-box
XLINK500-1	XLINK 500 no modem
XLINK500-1E	XLINK 500 no modem, NEMA 4-box
<b>Verizon LTE</b>	
XLINK100-C1-1	XLINK 100, Verizon LTE
XLINK100-C1-1C	XLINK 100, Verizon LTE, NEMA-4 box, external antenna
XLINK100-C1-1E	XLINK 100, Verizon LTE, NEMA-4 box, internal antenna
XLINK500-C1-1	XLINK 500, Verizon LTE
XLINK500-C1-1C	XLINK 500, Verizon LTE, NEMA-4 box, external antenna
XLINK500-C1-1E	XLINK 500, Verizon LTE, NEMA-4 box, internal antenna
<b>EU LTE</b>	
XLINK100-C3-1	XLINK 100, EU LTE
XLINK100-C3-1C	XLINK 100, EU LTE, NEMA-4 box, external antenna
XLINK100-C3-1E	XLINK 100, EU LTE, NEMA-4 box, internal antenna
XLINK500-C3-1	XLINK 500, EU LTE
XLINK500-C3-1C	XLINK 500, EU LTE, NEMA-4 box, external antenna
XLINK500-C3-1E	XLINK 500, EU LTE, NEMA-4 box, internal antenna
<b>Global HSPA</b>	
XLINK100-C5-1	XLINK 100, HSPA
XLINK100-C5-1C	XLINK 100, HSPA, NEMA-4 box, external antenna
XLINK100-C5-1E	XLINK 100, HSPA, NEMA-4 box, internal antenna
XLINK500-C5-1	XLINK 500, HSPA
XLINK500-C5-1C	XLINK 500, HSPA, NEMA-4 box, external antenna
XLINK500-C5-1E	XLINK 500, HSPA, NEMA-4 box, internal antenna
<b>Global Cat M1 LTE</b>	
XLINK100-C6-1	XLINK 100, Global LTE
XLINK100-C6-1C	XLINK 100, Global LTE, NEMA-4 box, external antenna
XLINK100-C6-1E	XLINK 100, Global LTE, NEMA-4 box, internal antenna
XLINK500-C6-1	XLINK 500, Global LTE
XLINK500-C6-1C	XLINK 500, Global LTE, NEMA-4 box, external antenna



XLINK500-C6-1E	XLINK 500,Global LTE, NEMA-4 box, internal antenna
<b>North America LTE</b>	
XLINK100-C7-1	XLINK 100, NA LTE
XLINK100-C7-1C	XLINK 100, NA LTE, NEMA-4 box, external antenna
XLINK100-C7-1E	XLINK 100, NA LTE, NEMA-4 box, internal antenna
XLINK500-C7-1	XLINK 500, NA LTE
XLINK500-C7-1C	XLINK 500, NA LTE, NEMA-4 box, external antenna
XLINK500-C7-1E	XLINK 500, NA LTE, NEMA-4 box, internal antenna
<b>Iridium</b>	
XLINK100-IR-1	XLINK 100, IRIDIUM
XLINK100-IR-1C	XLINK 100, IRIDIUM, NEMA-4 box, external antenna
XLINK100-IR-1E	XLINK 100, IRIDIUM, NEMA-4 box, internal antenna
XLINK500-IR-1	XLINK 500, IRIDIUM
XLINK500-IR-1C	XLINK 500, IRIDIUM, NEMA-4 box, external antenna
XLINK500-IR-1E	XLINK 500, IRIDIUM, NEMA-4 box, internal antenna
<b>Iridium DOD (Restricted)</b>	
XLINK100-IRD-1	XLINK 100, IRIDIUM DOD
XLINK100-IRD-1C	XLINK 100, IRIDIUM DOD, NEMA-4 box, external antenna
XLINK100-IRD-1E	XLINK 100, IRIDIUM DOD, NEMA-4 box, internal antenna
XLINK500-IRD-1	XLINK 500, IRIDIUM DOD
XLINK500-IRD-1C	XLINK 500, IRIDIUM DOD, NEMA-4 box, external antenna
XLINK500-IRD-1E	XLINK 500, IRIDIUM DOD, NEMA-4 box, internal antenna
<b>PLUGGABLE OPTIONS CARDS</b>	
IRIDIUM-MOD-1	Iridium telemetry pluggable modem card
IRIDIUM-MOD-1D	Iridium DOD (restricted) telemetry pluggable modem card
CELLULAR-MOD-1	Verizon LTE telemetry pluggable modem card
CELLULAR-MOD-3	EU LTE telemetry pluggable modem card
CELLULAR-MOD-5	HSPA telemetry pluggable modem card
CELLULAR-MOD-6	Global LTE telemetry pluggable modem card
CELLULAR-MOD-7	North America LTE telemetry pluggable modem card
<b>OTHER</b>	
8111-1113-1	Externally mounted RF coaxial lightning arrestor to be used on a NEMA-4 enclosure variant (3 ft type N male – N male cable included)

## 2 General Safety Information

---

### 2.1 English

- ▶ Please read the Operations & Maintenance Manual before using the Sutron XLINK 500/100 for the first time! Make yourself familiar with the installation and operation of the Sutron XLINK 500/100 and accessories! Keep the Operations & Maintenance Manual for later reference.
- ▶ Only install and maintain the XLINK 100/500 if you are appropriately qualified and trained for this purpose! If necessary, arrange training by OTT HydroMet.
- ▶ In addition, please observe all safety instructions and warnings given in the operating manuals of the rechargeable batteries and chargers as well as those printed on the device housings.
- ▶ Always observe the electrical and climatic limit values given in the specifications!
- ▶ Only use rechargeable batteries and chargers that are suitable and specified for the expected climatic conditions! Please note that temperatures up to 20 °C higher can occur inside a protective housing, which is exposed to direct sunlight!
- ▶ Make sure that XLINK 100/500 is protected against moisture (NEMA 4, IP 66 or better).
- ▶ Protect the line of the battery supply voltage with a safety fuse (5A/fast).
- ▶ Before connecting the power supply, check that all wires are properly attached to the screw terminal strips.
- ▶ Do not open XLINK 100/500. There are no user-serviceable parts inside.
- ▶ Have a defective XLINK 100/500 checked and repaired by the Sutron repair center. Do not attempt to repair XLINK 100/500 yourself.
- ▶ Operate XLINK 100/500 only with the approved antenna connected.
- ▶ The XLINK100/500 can be cleaned using common mild window cleaning products. Do not spray the cleaner directly on the XLink as the cleaner may run down into the device. Instead, spray the cleaner on to a clean cloth and then wipe the unit. Never spray cleaner directly on the terminal strips or on the wiring.
- ▶ The manufacturer is not responsible for any damages due to misapplication or misuse of this product including, without limitation, direct, incidental, and consequential damages, and disclaims such damages to the full extent permitted under applicable law. The user is solely responsible to identify critical application risks and install appropriate mechanisms to protect processes during a possible equipment malfunction.
- ▶ OTT Hydromet accepts no liability for damage resulting from the device not being used as intended. All warranty claims are nullified in this case. Unauthorized structural modifications, as well as additions or alterations to the device are prohibited. To ensure that the device is used as

intended, only connect and use accessories that have been approved by OTT Hydromet and spare parts approved by OTT Hydromet.

- ▶ **WARNING:** Risk of explosion. The XLINK 100/500 is not designed or rated for explosive atmospheres. Never operate the XLINK 100/500 in potentially explosive areas.
  
- ▶ **WARNING:** Health Hazard due to malfunctioning of cardiac pacemakers  
Electromagnetic fields due to the transmitted Radio Frequency signals can lead to malfunctioning of cardiac pacemakers. This can be life-threatening for users of pacemakers.
  - Always follow the recommendations and precautions of your medical provider
  - Always maintain a safe distance of 27 cm between the XLINK 100/500 and the cardiac pacemaker
  - Always ensure that the transmitter is disabled before approaching the transmit antenna.
  
- ▶ **CAUTION:** XLINK 100/500 Radio Frequency Exposure Hazard  
The XLINK 100/500 contains an internal Wi-Fi Module with an antenna.
  - The XLINK 100/500 should be installed to provide a separation distance of at least 27 cm from all persons.
  
- ▶ **CAUTION:** XLINK 100/500 Radio Frequency Exposure Hazard  
For a XLINK 100/500 containing a cellular or iridium option card, there is a potential RF exposure hazard from the corresponding transmit antenna.
  - The XLINK 100/500 cellular or iridium antenna should be installed to provide a separation distance of at least 27 cm from all persons.
  
- ▶ **CAUTION:** Risk of burns due to the hot surface at high ambient temperatures  
The metal parts of the XLINK 100/500 housing can become very hot at high ambient temperatures (> 60 C typically). This can result in burns.
  - Wear protective gloves during installation and maintenance
  - Wear protective gloves during installation and maintenance

---

**WARNING**



**Risk of fire and explosion if rechargeable batteries are handled improperly!**

- ▶ Avoid electrical short circuits!
- ▶ Avoid mechanical damages!
- ▶ Do not open rechargeable batteries!
- ▶ Do not throw rechargeable batteries into fire and/or expose them to high temperatures!
- ▶ Do not perform soldering work on rechargeable batteries!
- ▶ Protect rechargeable batteries from moisture!

---

**WARNING**



**Risk of burns due to accumulator acid!**

Rechargeable batteries contain highly corrosive acid. This acid can escape through degassing openings or if battery housing is damaged and cause severe burns to skin and eyes.

When handling rechargeable batteries:

- ▶ Wear eye protection!
  - ▶ Wear protective gloves!
  - ▶ Do not smoke!
-

## 2.2 French

- ▶ Veuillez lire le manuel d'utilisation et de maintenance avant d'utiliser le Sutron XLINK 100/500 pour la première fois! Familiarisez-vous avec l'installation et le fonctionnement du Sutron XLINK 100/500 et de ses accessoires! Conservez le manuel d'utilisation et d'entretien pour toute référence ultérieure
- ▶ N'installez et n'entretenez le XLINK 100/500 que si vous êtes dûment qualifié et formé à cet effet ! Si nécessaire, organisez une formation par OTT HydroMet.
- ▶ En outre, veuillez respecter toutes les consignes de sécurité et les avertissements figurant dans les manuels d'utilisation des piles rechargeables et des chargeurs, ainsi que ceux imprimés sur les boîtiers des appareils.
- ▶ Respectez toujours les valeurs limites électriques et climatiques indiquées dans les spécifications!
- ▶ N'utilisez que des piles rechargeables et des chargeurs qui sont adaptés et spécifiés pour les conditions climatiques prévues ! Veuillez noter que des températures jusqu'à 20 °C plus élevées peuvent se produire à l'intérieur d'un boîtier de protection, qui est exposé à la lumière directe du soleil!
- ▶ Assurez-vous que XLINK 100/500 est protégé contre l'humidité (NEMA 4, IP 66 ou mieux).
- ▶ Protégez la ligne de la tension d'alimentation de la batterie avec un fusible de sécurité (5A/rapide).
- ▶ Avant de brancher l'alimentation, vérifiez que tous les fils sont correctement fixés aux borniers à vis.
- ▶ N'ouvrez pas XLINK 100/500. Il n'y a pas de pièces réparables par l'utilisateur à l'intérieur.
- ▶ Faites vérifier et réparer un XLINK 100/500 défectueux par le centre de réparation Sutron. N'essayez pas de réparer XLINK 100/500 vous-même.
- ▶ Utilisez le XLINK 100/500 uniquement avec l'antenne approuvée connectée.
- ▶ Le XLINK100/500 peut être nettoyé à l'aide de produits de nettoyage pour vitres courants et doux. Ne vaporisez pas le nettoyant directement sur la XLink car il pourrait couler dans l'appareil. Vaporisez plutôt le nettoyant sur un chiffon propre, puis essuyez l'appareil. Ne vaporisez jamais le nettoyant directement sur les borniers ou sur le câblage.
- ▶ Le fabricant n'est pas responsable des dommages dus à une mauvaise application ou à une mauvaise utilisation de ce produit, y compris, mais sans s'y limiter, les dommages directs, accessoires et indirects, et rejette de tels dommages dans toute la mesure permise par la loi applicable. L'utilisateur est seul responsable de l'identification des risques liés aux applications critiques et de l'installation de mécanismes appropriés pour protéger les processus lors d'un éventuel dysfonctionnement de l'équipement.
- ▶ OTT Hydromet décline toute responsabilité pour les dommages résultant d'une utilisation non conforme de l'appareil. Dans ce cas, tous les droits de garantie sont annulés. Les modifications

structurelles non autorisées, ainsi que les ajouts ou les altérations de l'appareil sont interdits. Pour garantir une utilisation conforme de l'appareil, ne raccordez et n'utilisez que des accessoires et des pièces de rechange agréés par OTT Hydromet.

- ▶ **AVERTISSEMENT:** Risque d'explosion ! Le XLINK 100/500 n'est pas conçu pour les atmosphères explosives. N'utilisez jamais le XLINK 100/500 dans des zones à risque d'explosion.
- ▶ **AVERTISSEMENT:** Danger pour la santé dû au mauvais fonctionnement des stimulateurs cardiaques

Les champs électromagnétiques dus aux signaux radiofréquence transmis peuvent entraîner un dysfonctionnement des stimulateurs cardiaques. Cela peut mettre en danger la vie des utilisateurs de stimulateurs cardiaques.

- Suivez toujours les recommandations et les précautions de votre fournisseur de soins de santé.
  - Maintenez toujours une distance de sécurité de 27 cm entre le XLINK 100/500 et le stimulateur cardiaque.
  - Assurez-vous toujours que l'émetteur est désactivé avant d'approcher l'antenne d'émission.
- ▶ **PRUDENCE:** XLINK 100/500 Risque d'exposition aux radiofréquences.  
  
Le XLINK 100/500 contient un module Wi-Fi interne avec antenne.
    - Le XLINK 100/500 doit être installé à une distance d'au moins 27 cm de toute personne.
  - ▶ **PRUDENCE:** XLINK 100/500 Risque d'exposition aux radiofréquences  
  
Dans le cas d'une XLINK 100/500 contenant une carte cellulaire ou une carte optionnelle iridium, l'antenne d'émission correspondante présente un risque potentiel d'exposition RF.
    - L'antenne cellulaire ou iridium XLINK 100/500 doit être installée à une distance d'au moins 27 cm de toute personne.
  - ▶ **PRUDENCE:** Risque de brûlures dues à la surface chaude à des températures ambiantes élevées  
  
Les parties métalliques du boîtier XLINK 100/500 peuvent devenir très chaudes à des températures ambiantes élevées (> 60 °C en général). Cela peut provoquer des brûlures.
    - Porter des gants de protection pendant l'installation et l'entretien.



**AVERTISSEMENT**



**Risque d'incendie et d'explosion si les piles rechargeables ne sont pas manipulées correctement!**

- ▶ Évitez les courts-circuits électriques!
  - ▶ Évitez les dommages mécaniques!
  - ▶ N'ouvrez pas les piles rechargeables!
  - ▶ Ne pas jeter les piles rechargeables dans le feu et/ou les exposer à des températures élevées!
  - ▶ Ne pas effectuer de travaux de soudure sur les piles rechargeables!
  - ▶ Protégez les piles rechargeables de l'humidité!
- 

**AVERTISSEMENT**



**Risque de brûlure par l'acide de l'accumulateur!**









Les piles rechargeables contiennent un acide très corrosif. Cet acide peut s'échapper par les ouvertures de dégazage ou si le boîtier de la batterie est endommagé et causer de graves brûlures à la peau et aux yeux.

Lors de la manipulation de piles rechargeables:

- ▶ Portez des lunettes de protection!
  - ▶ Portez des gants de protection!
  - ▶ Ne pas fumer
-

## 3 Symbols used in the manual

---

Symbol	Description
	Direct current.
	Protective earth ground. Connect to an earth ground electrode for lightning protection of internal components.
	Digital ground. Attach digital sensor ground to this terminal. Batteries and solar panel negative terminals are also connected to this terminal.
	Signal ground. Attach analog sensor ground to this terminal.
	Chassis ground.
	Shock hazard.
	Do not dispose of in the trash.
	Warning
	Information

# 4 Introduction

Sutron's XLink products are site controllers with optional built-in modems. These products are designed to collect, store, and transmit sensor data. The devices have been designed for hydrometry, meteorology, and environmental monitoring. Two models are available: XLink 500 and XLink 100.



XLink can:

- ▶ Make measurements from sensors monitoring the environment
- ▶ Perform special calculations
- ▶ Record data into non-volatile memory
- ▶ Transmit data to automated receiving systems.

XLink offers several means of telemetry:

- ▶ Cellular modem (different models available suitable to the region)
- ▶ Iridium modem

This family of XLink products builds upon its predecessors. New enhancements:

- ▶ Expanded measurements from 16 to 32
- ▶ Improved analog accuracy & additional channels (XLink 500 only)
- ▶ Python programming (XLink 500 only)
- ▶ Interchangeable modems
- ▶ Expanded log from 120,000 to 1,000,000 readings, expandable to 1,000,000,000 readings (32 GB) via internal SDHC card

## 4.1 XLink 500

The figure below shows the connections provided by the XLink 500:

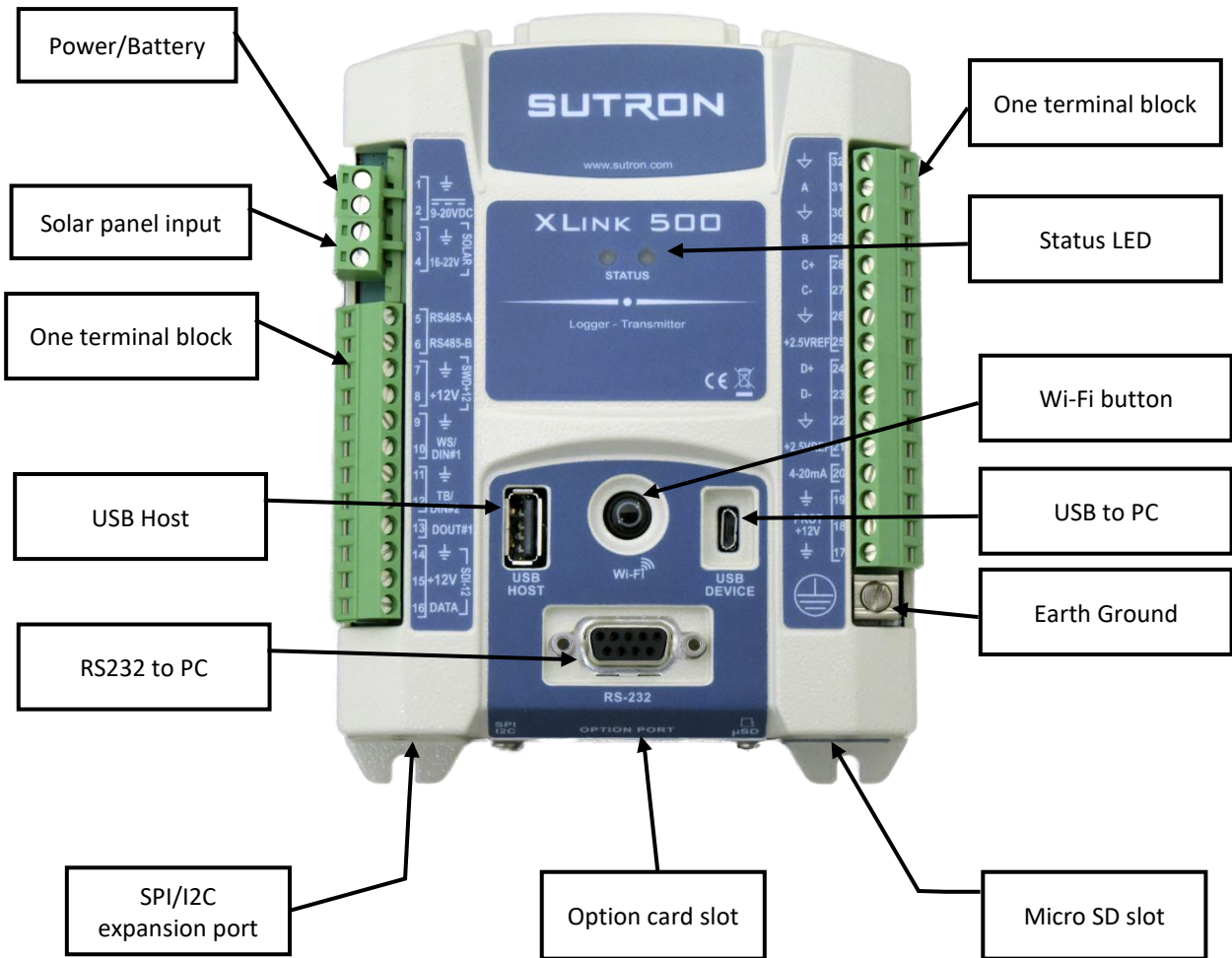

## 4.2 XLink 100

The figure below shows the connections provided by the XLink 100.

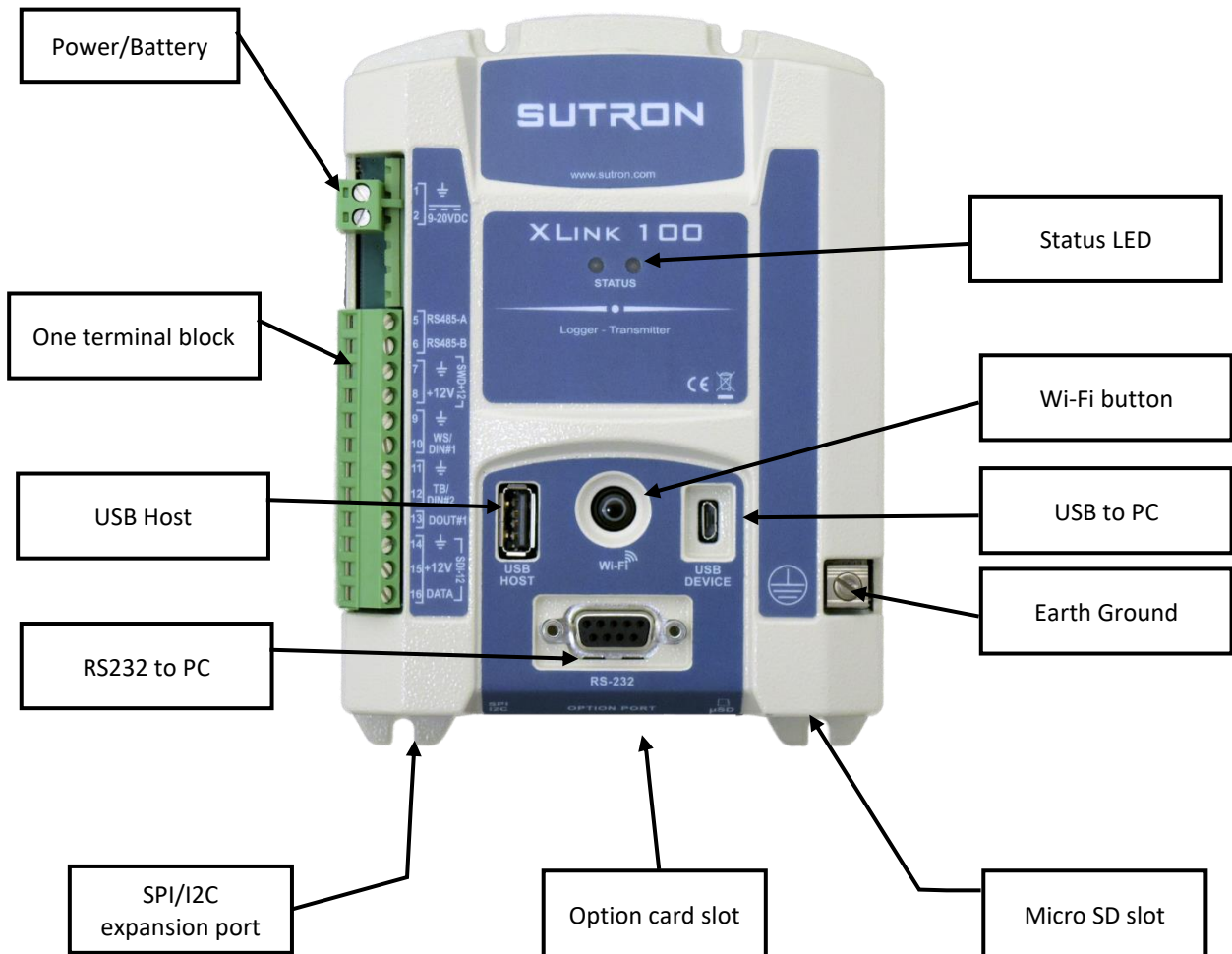

## 4.3 Multi-function Button

There is a multi-function button installed on the front.

- ▶ Briefly pressing this button will turn on the Wi-Fi.
- ▶ The multi-function button may be used to reboot the unit. If the button is held down for 5 seconds, the red LED will come on. Keep holding the button until the red LED turns off in order to reboot.

## 4.4 Status LEDs

The status LEDs give information on how the unit is operating. The LED are multi-colored. The following table describes the different colors and states of the LED.

Description	Left/Top LED	Right/Bottom LED	Button
Unit is operating properly	Green blink every 5 seconds		
Unit has a Setup or operating error		Red blink every 3 seconds	
Multi-function button pressed			Fast flashing blue
Wi-Fi turned on but no one connected			Blue blink every 3 sec
Active Wi-Fi Connection			Solid Blue
Transmitting		Solid Blue	
Power Fail Imminent		Red flash 9Hz	
Unit is in Test mode	Green blink every second	Red blink every second	
USB Thumb Drive Operation	Amber blink while operation is in progress. Green LED on solid if operations complete successfully.	Red LED on solid if operations fails.	

### 4.4.1 Power on sequence

When power is applied to the unit, the following light sequence will take place:

- ▶ Immediately after power on, system software will briefly blink amber and purple LEDs.
- ▶ As the system completes bootup, it will light up in a colorful sequence
  - ▶ Button, green, blue, amber, purple, amber, green, all off

- ▶ As the system continues to operate, it will either blink red (indicating errors) or green (system running)
- ▶ A failure of the system to display the power on sequence generally indicates either a problem providing power to the unit, or a hardware failure that requires repair.

## 4.5 RS-232

The RS-232 connection is a standard DB9-F connection for serial communications to a PC or other device. The RS-232 port has a default baud rate of 9,600 (No parity, 8 data bits, 1 stop bit, HW flow control) but other baud rates are supported.

- ▶ DTR must be asserted to talk to the unit via RS-232.
- ▶ Please note that the unit will NOT go into low power mode if DTR is asserted.

The RS-232 port may be used for connecting to a PC for setup, maintenance, and troubleshooting. However, the micro USB port provides higher throughput and is the recommended communication method.

The port may also be used for collecting data from Modbus sensors.

Python scripts may use the RS232 port in order to drive displays, send data to modems, or communicate with other devices.

## 4.6 USB Micro (OTG)

The USB OTG port is the primary port for connecting to a PC. The USB port is a micro-B and compatible with a standard micro-B to Type A male USB cable that works with most PC's. The primary use of the connection is to allow the PC to setup, maintain and troubleshoot the unit. The PC will typically run LinkComm software to configure the unit.

## 4.7 USB Host

The USB Host connection provides a simple way to download sensor data or update the firmware in the unit using a USB flash drive (aka USB thumb drive). Plugging in a flash drive will automatically download all logged data since the last download and store the log on the flash drive. It will also store station setup and status on the flash drive.

It is possible to change station setup, upgrade firmware, and execute a batch file via a flash drive. For details, please see section [7.15-USB THUMB DRIVE \(FLASH DRIVE\) OPERATION](#).

## 4.8 XLINK-500 and XLINK-100 Left Terminal strip

XLINK-500 has two terminal strips to provide the connections for sensors and outputs. XLINK-100 has only one terminal strip on left side.

The table below describes the purpose of each connection on the left terminal strip for XLINK-500 and XLINK-100

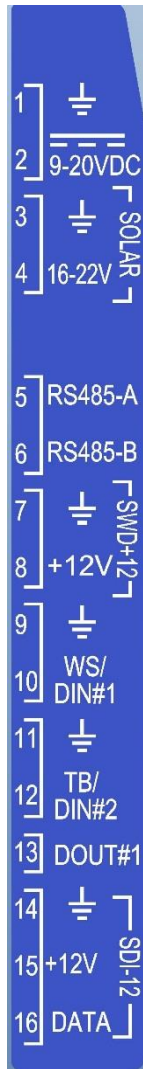

	Description	Note
1	GND	Main Battery/Power Ground
2	9-20VDC	Main Battery/Power
3	GND	Solar panel -
4	+ Solar (20 W max)	Solar Panel +

5	RS485 A	SDI-12 over RS-485, Modbus over RS-485
6	RS485 B	SDI-12 over RS-485, Modbus over RS-485
7	Ground	Ground
8	+SW POWER	Switched Main Power (9-20VDC) (turned on during warm-up and analog sensor measurement)
9	Ground	Ground
10	WS/DIG IN 1	Wind Speed or Digital Input 1
11	Ground	Ground for sensor
12	TB/DIG IN 2	Tipping Bucket or Digital Input 2
13	DOUT	Digital Output (open collector, turned on manually, with alarms, or via equations)
14	Ground	Ground
15	SDI-12 PWR	Isolated Main Power (9-20VDC) to SDI-12 sensors (500 ma max)
16	SDI-12 DATA	SDI-12 Data



## 4.9 XLINK-500 Right Terminal Strip

The table below describes the purpose of each connection on the right terminal strip on XLINK-500. No connections except for Earth Ground are available on XLINK-100

	Description	Note
32	Analog Ground	Analog ground
31	0-5V A	Voltage input for sensors with 0-5V output
30	Analog Ground	Analog ground
29	0-5V B	Voltage input for sensors with 0-5V output
28	Diff C+	Differential voltage input for bridge type sensors
27	Diff C-	Differential voltage input for bridge type sensors
26	Analog Ground	Analog ground
25	VREF	2.5V output (turned on during warm-up and analog sensor measurement)
24	Diff D+	Differential voltage input for bridge type sensors
23	Diff D-	Differential voltage input for bridge type sensors
22	Analog Ground	Analog ground
21	VREF	2.5V output (turned on during warm-up and analog sensor measurement)
20	4-20mA	4-20mA input
19	GND	
18	PROT +12V	Isolated main power, 0.75
17	GND	
	Earth Ground	Attach via a heavy gauge (4 to 10 AWG) wire to earth ground rod driven 6 feet into earth.



## 5 Installing XLink

---

### 5.1 Attaching XLink 500 and 100

Requirements of the intended installation site are:

- ▶ Sufficient protection from moisture for an IP 41 device.
- ▶ Proper space for the electrical cables
- ▶ Battery cable shall have an inline fast fuse to handle current up to 5A
- ▶ Temperature range -40C to +70C.
- ▶ Space for installation using the mounting ears
- ▶ Earth ground point
- ▶ Closed control cabinet or fire protection cabinet if the power supply is not a low power source 12-20VDC.



**A minimum 70C rated cable/wire is recommended to be used for installation.**

The dimensions are shown in inches in the figure below along with the locations of the mounting ears.

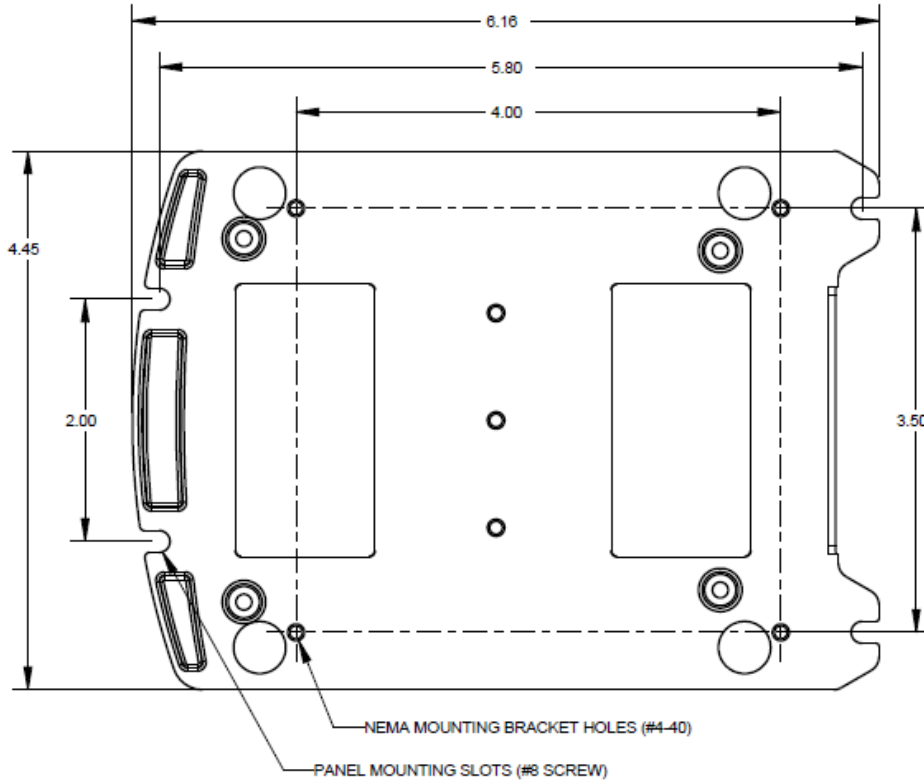

## 5.2 Installing Option Cards

An XLink may be ordered with either a Cell or Iridium card from the factory which will be preinstalled into the unit. If you choose to change the card in your unit, you will need to do the following.

The image below shows the option card.



1. Remove power from the unit and disconnect USB cable.
2. Remove the 2 screws holding the option card in place.
3. Note that CELLULAR cards may need a SIM card installed on the modem before you install the card. You will also need the IMEI number on the modem to activate your data plan. Duplicate stickers containing the IMEI number are sent for you to attach to the outside of the unit for future.



4. Slide the option card into the open port. You may need to unscrew the 2 screws on the option card a little to allow the card to slide into the slot fully. Note that the orientation of the option card always has the text right side.
5. The card should sit fully in the slot recess before you screw in the 2 screws. Once it is in position, screw both screws in to fix the card in place.
6. The card is now fully installed, and you may apply power to the unit. The new option card should be automatically detected. You can verify this by navigating to the Diagnostics tab in LinkComm and looking in the "Firmware Versions" box which lists the radios installed and associated serial numbers.

You will need to activate your modem and data plan by contacting your provider and supplying them with IMEI number located on the modem. Both Cell and Iridium will have an IMEI number. The activation process may take 30 minutes or more.

Please make sure to connect the antenna!

## 5.3 Earth Ground Point



A connection point has been provided for an Earth ground. Always connect the earth ground to a suitable ground at the site as described below.

Any time a sensor cable is attached to the terminal strip, the unit may be exposed to electrical surges such as those that come from nearby lightning strikes. The unit includes spark gaps and other protection devices that shunt the energy to the earth ground. If there is no connection to the earth ground point, the energy has nowhere to go, and the unit can be damaged.



**Failure to properly connect the Earth ground point will lead to failures in the field due to surges.**

To install a proper ground connection point:

- ▶ Use a copper ground rod driven into the ground at least 6 feet.
- ▶ Attach a very heavy gauge (#4 Solid Copper) wire between the rod and the Earth ground point on the unit. The connection point can accept up to a 4-gauge solid copper wire. If a heavier gauge copper wire is used to connect to the ground rod, a reducer may be necessary to connect to the terminal on the unit.



**Firmly secure the screw on the ground point firmly on the copper wire. Do not rely on AC power ground connections as they are not always properly grounded and may introduce other surges.**

Gas tube protection exists on the following inputs, based on the model:

- ▶ XLINK 500
  - ▶ SDI-12
  - ▶ RS-485
  - ▶ DIN1 and DIN2
  - ▶ DOUT
  - ▶ VREF
  - ▶ Analog A
  - ▶ Analog B
  - ▶ Analog Diff C
  - ▶ Analog Diff D
  - ▶ 4-20mA
- ▶ XLINK 100

- ▶ SDI-12  
RS-485

## 5.4 Connecting the Power Supply

The station provides a means of directly connecting a power supply and a solar panel.

Note: The power supply terminals are removable and serves as the pain power connect/disconnect.

### 5.4.1 Connecting the Battery

The unit operates off 9-20V.

Note: Even though the unit will operate below 12V some sensors will not operate when the power supply is below 12V.

A standard 12VDC lead-acid or Gel battery is typically used as the power source. Do not power the unit off AC power supplies without additional precautions to ensure the power supply is properly rated and the system is enclosed in a fire protection cabinet.

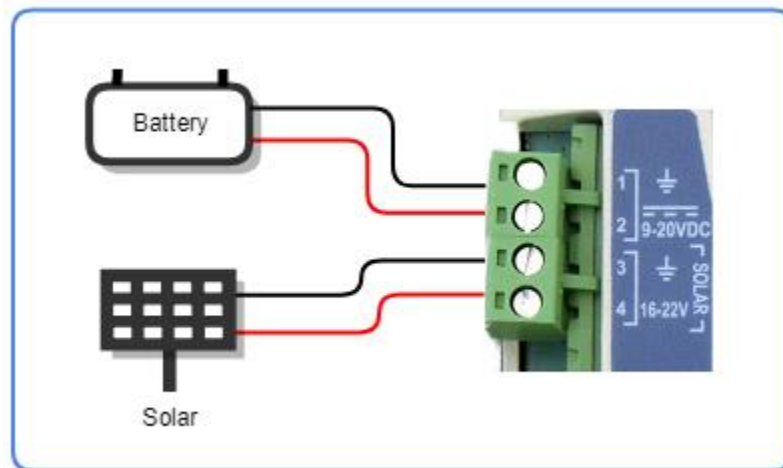

Battery cable shall have an inline fast fuse to handle current up to 5A

It is a good practice to make all sensor connections with the unit powered off.

As soon as power is applied, the LED will flash as the unit goes through a self-test sequence. The LED will flash green when the unit is running, and there are no problems. Red means there is an issue that requires user intervention. It could mean that there is a problem or that the unit has not been setup.

Please note that it is normal for the red LED to flash when power is first applied. Once the unit has verified good network signal (Iridium or Cell), it will switch to flashing green. Do not walk away from the site until the unit is flashing green! Connect with LinkComm to see why the red LED is flashing.

Normally the button will flash blue every 3 seconds indicating that Wi-Fi is turned on and ready for a connection. Other combinations are possible if the unit has been previously setup. See section [4.4-STATUS LEDs](#).

#### 5.4.2 Connecting the Solar Panel

The XLink 500 features a built-in solar panel regulator capable of handling a solar panel providing up to 20 Watts. The panel shall be connected to the terminal inputs labeled SOLAR. The panel should provide a voltage in the range of 16 to 22 Volt.

The solar panel input with sufficient sun illuminating the panel will power the station in situations where the battery needs to be removed from the circuit momentarily for replacement. Long-term operation without the battery connected is not recommended, and transmissions via internal Iridium or Cellular modems may not be possible as the solar regulator is not capable of supplying the necessary current during transmissions.

- *You may connect a power source other than a solar panel (e.g., a power supply) as long as it conforms to the voltage specification above.*
- *Please note that a battery is still required for long-term operation and to ensure enough current is available for reliable transmissions.*

Provisions are made in the circuitry to prevent discharge of the battery through the solar panel at night. No external reverse blocking diode is needed. In addition, the regulator is of a series pass type which means that a 15V DC power supply could be connected to the solar panel inputs to float charge the battery.

The charger is designed for 12V sealed lead acid (SLA) battery “gel cell” and has a built-in temperature coefficient to accommodate the temperature dependent charging requirements of a gel cell. The Maximum battery size recommended for this charger is a 7AHr gel cell battery. If the station requires larger battery sizes, Sutron recommends using an external solar charger regulator such as the Sutron model 5100-0411 or similar.

Assistance in calculating power budgets may be found here:

[HTTP://WWW.SUTRON.COM/WP-CONTENT/UPLOADS/2013/12/POWERBUDGET\\_BATTERYLIFE\\_SOLARPANELS.PDF](http://www.sutron.com/wp-content/uploads/2013/12/POWERBUDGET_BATTERYLIFE_SOLARPANELS.PDF)



## 5.5 Connecting SDI-12 sensors

There is an SDI-12 bus for sensor connections. The bus has an isolated power connection rated for 500mA. Because SDI-12 sensors are addressable, multiple SDI-12 sensors may be connected to this terminal if no two sensors have the same address.

When multiple new SDI sensors are connected to a bus, they should be connected one at a time, so the address can be made unique using the SDI A command. For details, please see the section [18.4-SETUP OF SDI SENSORS](#).

The figure below shows the typical SDI-12 connection:

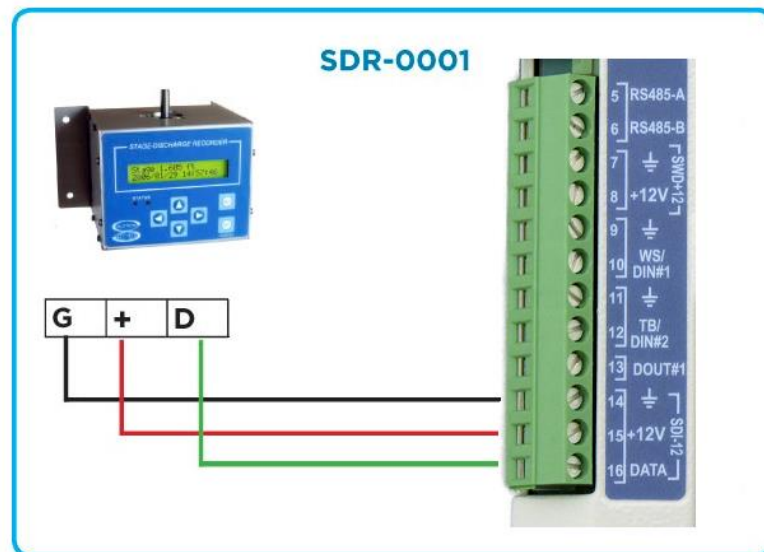

## 5.6 Connecting RS-485 Sensors

The RS-485 bus may be used to collect data from sensors. Alternatively, it may be used to have a Modbus client collect data from the station.

- ▶ RS-485 sensors that use the SDI-12 protocol for its messaging are supported.
- ▶ Collecting data using the Modbus protocol over RS-485 is supported
- ▶ Multiple devices may be attached on the RS-485 bus; each of those devices must have a different address.
- ▶ It is OK to mix SDI-12 and Modbus sensors on the RS-485 bus.

Wiring RS-485 involves two lines: RS-485 A and RS-485 B.



Note: if there is an issue talking to a sensor over RS-485, try reversing the A and B wires. If a Modbus sensor is not responding, make sure that the Modbus communications settings in XLink match the sensor settings.

## 5.7 Connecting Tipping Bucket Rain Gauge

A tipping bucket rain gauge is supported via the TB/DIN#2 connection. This connection provides a pull-up resistor (100K) to 3.3V to provide power for the contact switch in the rain gauge. Each time the bucket in the rain gauge “tips” the internal switch closes momentarily causing a pulse on the TB/DIN#2 connection. This pulse is counted and used to provide accumulated precipitation or precipitation rate data.

The key settings for a tipping bucket rain gauge are:

- ▶ Measurement Type: Precip Accumulation or Precip Rate
- ▶ Slope: 0.1mm, 0.2mm, 0.01inches or other value to match the calibration of the sensor.

Note: Measurement type: digital/counter1 or counter2 can also be used for tipping bucket rain gauges. Be sure to select “debounce” for this measurement type as most tipping bucket rain gauge switches are noisy and can produce multiple counts per tip if they are not de-bounced.

For more information, please see section [10.3.2-MEASURE TYPE: PRECIP ACCUMULATION AND PRECIP RATE.](#)

The typical connection of the tipping bucket rain gauge is shown below.

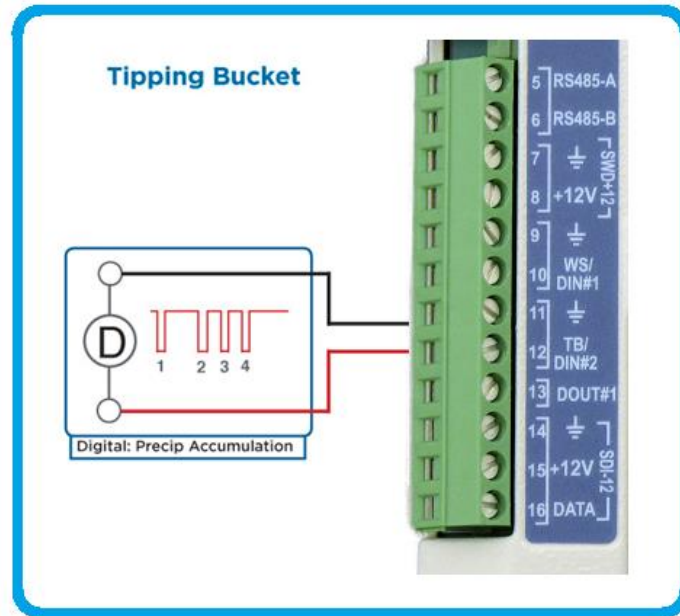

## 5.8 Connecting Pulse Sensors

Up to two sensors with pulse output are supported. The pulse output can come from a switch that is momentarily closed (as in most flow meters and tipping buckets), or it can come from a device that actively puts out pulses to represent the value to be measured. Pulses are measured by the Digital inputs DIN#1 or DIN#2. Output can be counted at a rate up to 10,000 counts per second (de-bounce off). If the signal provided by the device is not clean, de-bouncing should be enabled. Otherwise, noise may be counted as signal. To ensure that the de-bouncing does not interfere with the pulse counting, de-bouncing should only be enabled for signals occurring less than 100 times per second.

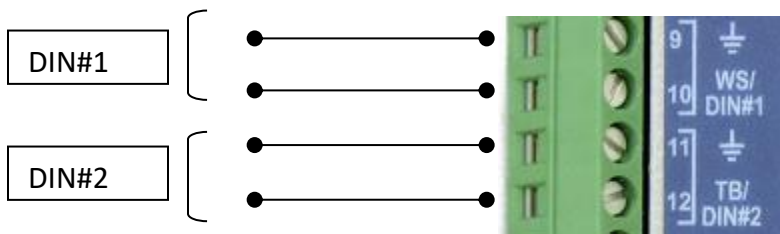

The key settings for pulse sensors are:

- ▶ Measurement Type: Digital
- ▶ Digital type: Counter 1 or Counter 2
- ▶ Debounce: yes/no

## 5.9 Connecting Frequency Sensors

Up to two sensors with frequency output are supported. The pulse output can come from a switch that is momentarily closed as in most flow meters and tipping buckets, or it can come from a device that actively puts out pulses to represent the value to be measured such as a soil moisture probe with frequency output or an anemometer.

The pulse output sensors connect to the DIN #1 or DIN #2 inputs. DIN #1 supports sensors with a low-level AC output (100 mV peak-peak) or high-level output while DIN#2 supports only sensors with a high-level output (switch closure, 0-3VDC, or 0-5VDC).

The frequency measurement circuitry can measure frequencies from 3Hz to 10KHz with an accuracy of 0.01%. The system takes 0.75 seconds to make the measurement.

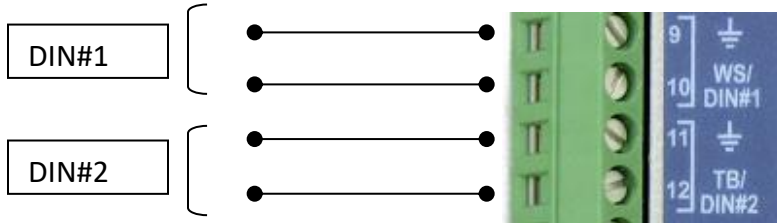

The key settings for frequency sensors are:

- ▶ Measurement Type: Digital
  - ▶ Digital type: Frequency 1 or Frequency 2
- Note: Use Frequency 1 for sensors with a low-level AC output voltage (such as an RMYoung) and specify (AC Low Level). Frequency 2 is always expecting a DC high-level signal.

## 5.10 Connecting 0-5V Analog Sensors

Some models support analog sensors with an output voltage up to 5 VDC. The sensors must be connected to the signal ground and may be powered from VREF, PROT+12V, SWD+12V.

These inputs are intended for sensors that provide low impedance voltage outputs. For high impedance resistive bridge type sensors, the differential inputs are recommended for highest accuracy.

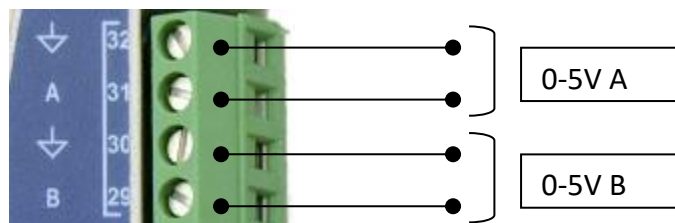

The key settings for 0-5V analog sensors are:

- ▶ Measurement Type: Analog

- ▶ Analog Type: 0-5V A or B.

## 5.11 Connecting 4-20ma Analog Sensors

Certain models support up to three sensors with a 4-20mA output. One sensor can connect directly to the 4-20mA input as shown below. The other sensors can connect to A or B (0-5V) analog channels with an external load resistor. The sensor/loop must be powered from PROT+12V, SWD+12V, main power, or other source with common ground.

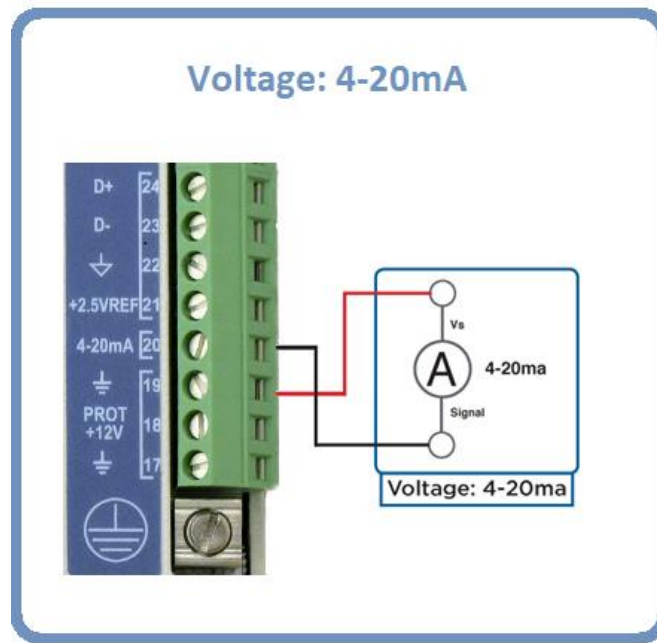

The key settings for 4-20mA sensors connected to the 4-20mA input are:

- ▶ Measurement Type: Analog
- ▶ Analog Type: 4-20mA

The built-in 4-20mA connection has an internal 200 Ohm load consisting of transient protection and a precision 100 Ohm sense resistor. External load resistors should also be 100 Ohm for the system to operate down to voltages between 10-12VDC. In some cases, the 4-20mA sensor may need supply voltages > 12VDC to operate. The supply voltage needs to be greater than the minimum voltage the sensor requires plus the maximum voltage across the load resistance (2V for 100 ohms).

The key settings for 4-20mA sensor connected to A and B are:

- ▶ Measurement Type: Analog
- ▶ Analog Type: 0-5V A or B.
- ▶ Add a 100 Ohm load resistor between A or B and Signal ground.

## 5.12 Connecting Status Sensors

A status output is a switch that is open or closed. Up to two status outputs are supported using either of the digital inputs (DIN#1 or DIN#2). An internal pull-up resistor on DIN#1 or DIN#2 provides the excitation voltage for the switch.

Measurement result will be zero when the switch is open and one when the switch is closed.

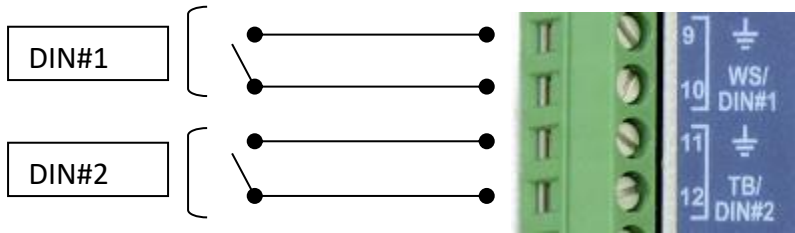

The key settings for pulse sensors are:

- ▶ Measurement Type: Digital
- ▶ Digital type: Level 1 or Level 2

## 5.13 Connecting Potentiometer Sensors

A potentiometer connects to the A or B analog channels as shown below.

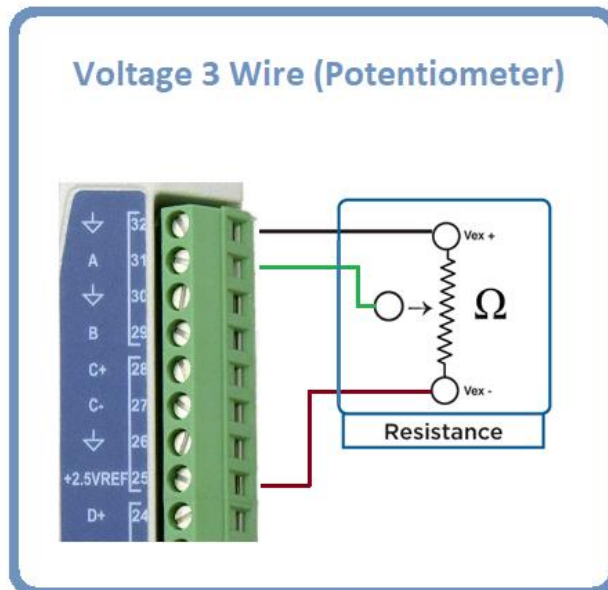

The key settings for potentiometer sensors are:

- ▶ Measurement Type: Analog
- ▶ Analog type: A or B

Note: VREF is 2.5V.

## 5.14 Connecting mV Sensors

mV output sensors such as pyranometers connect to the C or D analog channels as shown below:

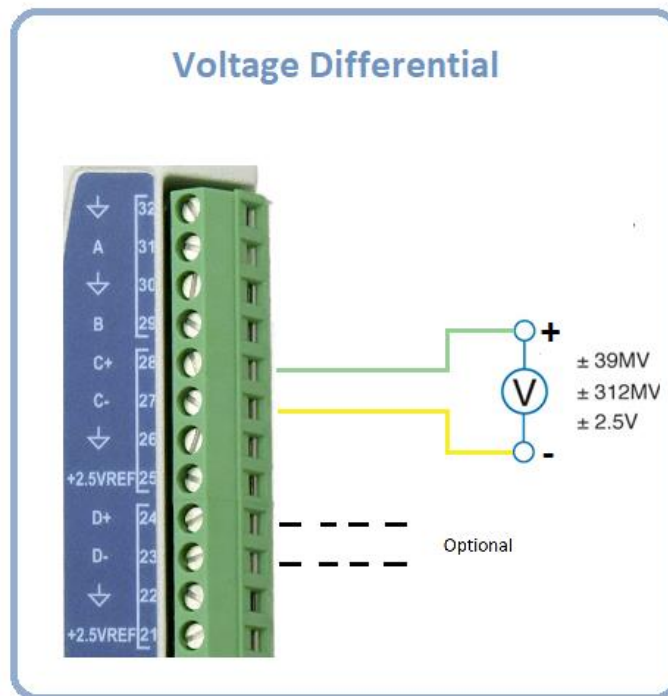

The key settings for mv output sensors are:

- ▶ Measurement Type: Analog
- ▶ Analog type: Diff C or D
- ▶ Input Range: 39mV, 312mV, 2.5V, 39mV w/Bias, 312mV w/Bias.

Note: use the range with Bias for any sensor (such as a pyranometer) that does not connect to VREF or other power source.

## 5.15 Connecting Thermistors

Thermistors connect to the differential input channels C or D.

Please make sure to provide and connect a precision 10K reference resistor as pictured below:

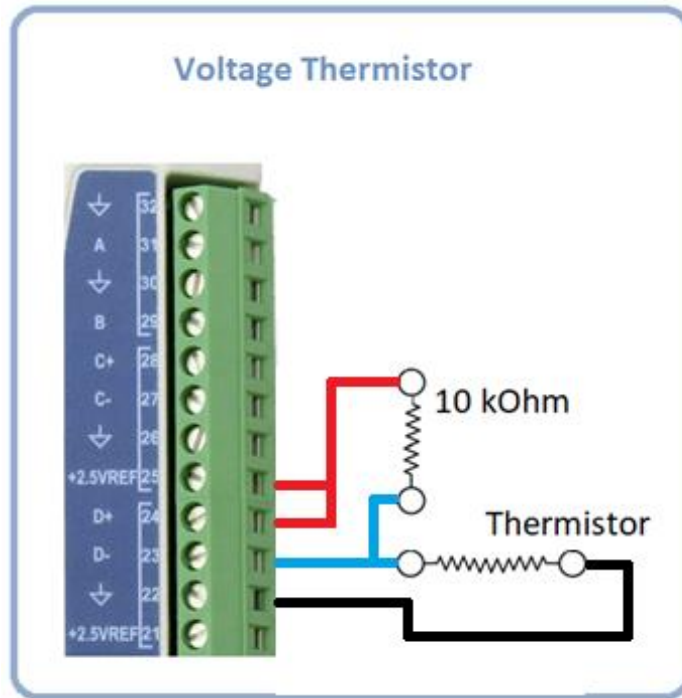

The key settings for thermistors are:

- ▶ Measurement Type: Analog
- ▶ Analog type: Differential C or D
- ▶ Input Range: -2.5 to 2.5V
- ▶ Equation to compute temperature (Celsius):  
Steinhart( $10000 * ((VREF/X) - 1)$ , A, B, C) (see table below for A, B, C)  
Note: The 10000 is the reference resistor value in ohms.
- ▶ Slope: 1.8; Offset: 32 to convert to Fahrenheit.

Model	TYPE	A	B	C
44007 44034	YSI MIX B, 5K	0.0012829	0.0002365	9.1883E-08
44006 44031	YSI MIX H, 10K	0.0010295	0.0002391	1.568E-07
44005 44030	YSI MIX B, 3K	1.40510E-03	2.36900E-04	1.019E-07
44008 44032	YSI MIX H, 30K	9.35401E-04	2.21060E-04	1.2747E-07
44016 44036 5600-0025 5600-0030	YSI MIX B, 10K	1.12610E-03	2.34545E-04	8.6359E-08



Campbell Scientific’s CS205 & CS107 temperature probe requires different wiring than the above since it has a reference resistor built into the probe. The wires are connected as indicated below on the left, and the equation will use the built-in template for CS205/107. The image on the right indicates the probe’s internal wiring for reference.

- Jumper C+ to Vref
- Purple (AG) ----- C+
- Red (HI) ----- C-
- Black (EX) ----- AGND
- Clear (G) ----- Earth Ground

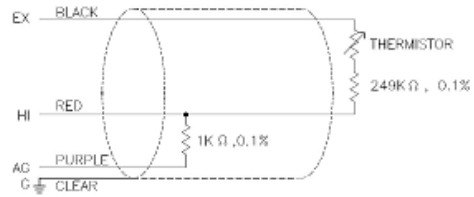

## 5.16 Connecting Thermocouples

Thermocouples connect to the C or D channels as shown below.

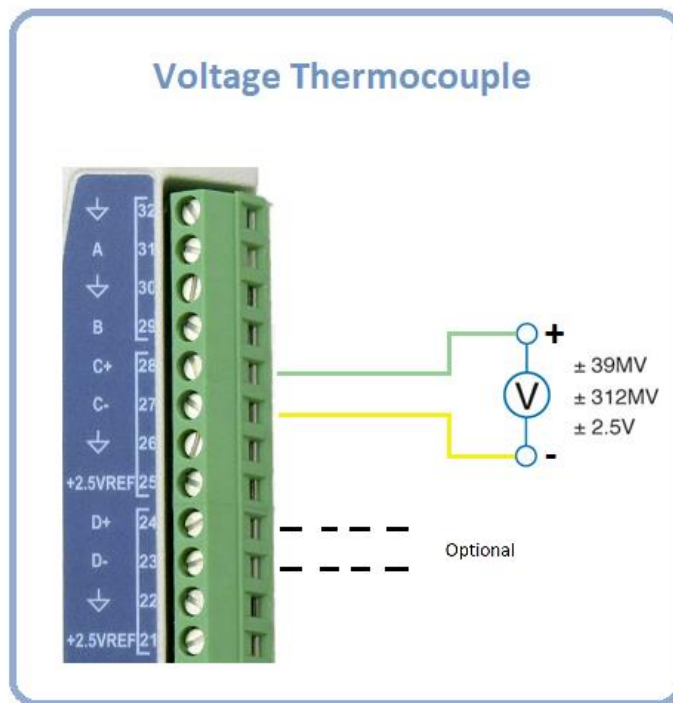

The key settings for thermocouples are:

- ▶ Measurement Type: Analog
- ▶ Analog type: Diff C, D or E.
- ▶ Input Range: 39mV with Bias
- ▶ Equation:  $24716 * X + \text{Terminal\_temp}$  {K type thermocouple, -8C to 64C}

For more accurate results, here are some other K-Type Equations:

Linear delta T range of  $\pm 20^{\circ}\text{C}$ . Approximation error is  $\pm 0.20^{\circ}\text{C}$ .

$$\text{Temp } (^{\circ}\text{C}) = 25.346 * X*1000 - 0.1114 + \text{Terminal\_temp}$$

Linear delta T range of  $\pm 40^{\circ}\text{C}$ . Approximation error is  $\pm 0.83^{\circ}\text{C}$ .

$$\text{Temp } (^{\circ}\text{C}) = 25.419 * X*1000 - 0.3847 + \text{Terminal\_temp}$$

3<sup>rd</sup> order Poly delta T range of  $\pm 20^{\circ}\text{C}$ . Approximation error is  $\pm 0.01^{\circ}\text{C}$

$$\text{Temp } (^{\circ}\text{C}) = \text{Poly}(X*1000), (\text{Terminal\_temp} - 0.0107), 25.263, -0.4443, 0.2053)$$

3<sup>rd</sup> order Poly delta T range of  $\pm 40^{\circ}\text{C}$ . Approximation error is  $\pm 0.03^{\circ}\text{C}$

$$\text{Temp } (^{\circ}\text{C}) = \text{Poly}(X*1000), (\text{Terminal\_temp} - 0.0115), 25.326, -0.4305, 0.0861)$$

#### **T-Type Equations:**

Linear delta T range of  $\pm 20^{\circ}\text{C}$ . Approximation error is  $\pm 0.30^{\circ}\text{C}$ .

$$\text{Temp } (^{\circ}\text{C}) = 25.892 * X*1000 - 0.151 + \text{Terminal\_temp}$$

Linear delta T range of  $\pm 40^{\circ}\text{C}$ . Approximation error is  $\pm 1.20^{\circ}\text{C}$ .

$$\text{Temp } (^{\circ}\text{C}) = 25.851 * X*1000 - 0.612 + \text{Terminal\_temp}$$

3<sup>rd</sup> order Poly delta T range of  $\pm 20^{\circ}\text{C}$ . Approximation error is  $\pm 0.01^{\circ}\text{C}$

$$\text{Temp } (^{\circ}\text{C}) = \text{Poly}(X*1000), (\text{Terminal\_temp} + 0.0051), 25.881, -0.688, 0.0277)$$

3<sup>rd</sup> order Poly delta T range of  $\pm 40^{\circ}\text{C}$ . Approximation error is  $\pm 0.03^{\circ}\text{C}$

$$\text{Temp } (^{\circ}\text{C}) = \text{Poly}(X*1000), (\text{Terminal\_temp} + 0.0234), 25.868, -0.755, 0.0616)$$

## 5.17 Connecting Strain Gauges

Strain gauges connect to the C, D or E channels as shown below.

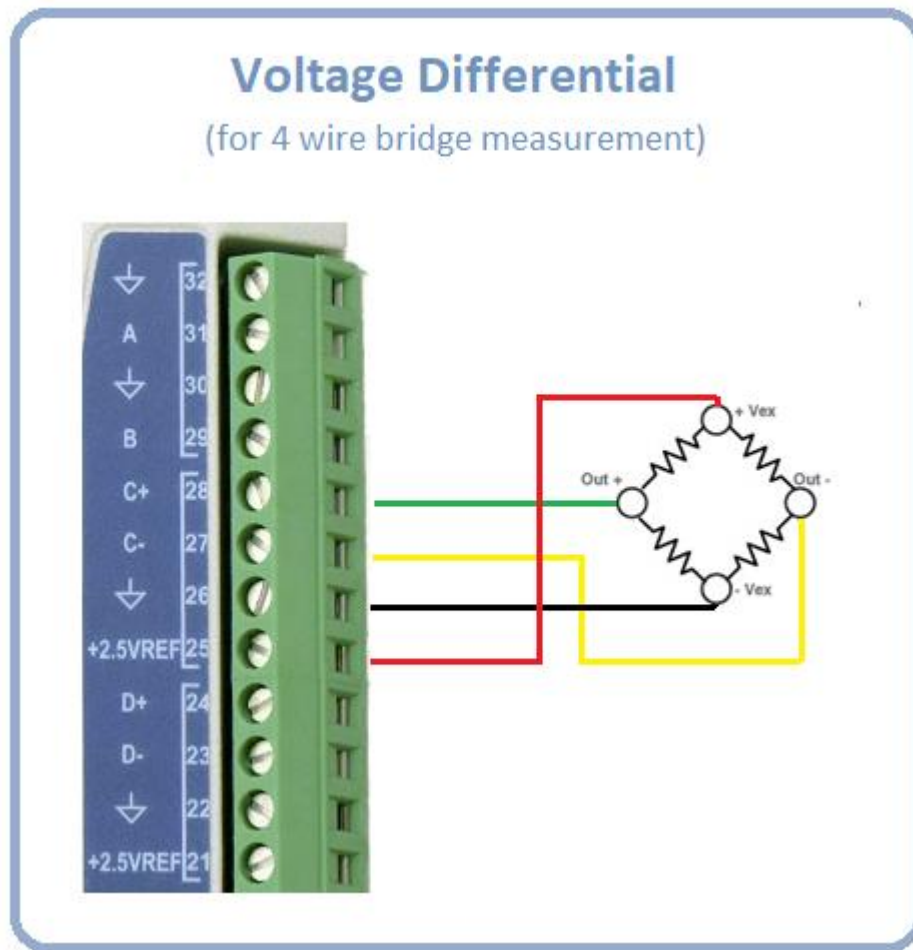

The key settings for strain gauge sensors are:

- ▶ Measurement Type: Analog
- ▶ Analog type: Diff C, D or E
- ▶ Input Range: 39mV or 312mV (\*\*no bias needed)
- ▶ Slope: as needed to scale the reading.

## 5.18 Programmable Excitation References

The built-in excitation reference voltage is 2.5 volts available on multiple pins.

## 5.19 Connecting Prop/Vane or Anemometer/Vane Wind Sensors

The prop/vane or anemometer/vane wind sensors like the RMYoung wind sensor typically have a potentiometer for direction and frequency output for speed. The RMYoung connects as shown below. WS/DIN#1 is used for the frequency as it can handle low-level AC as well as high-level DC pulses for speed.

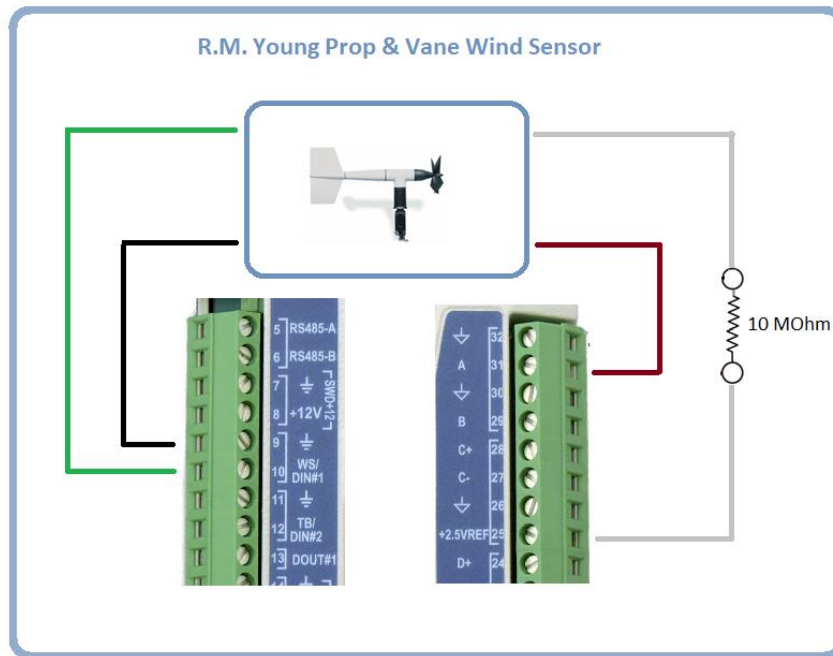

\* A 1.0 MOhm resistor needs to be placed from VREF (or SIGNAL GROUND) to AZ SIG. This ensures that the value always goes to 355 (or 0 with SIGNAL GROUND) when the potentiometer is in the open region.

Setup two measurements for the RMYoung – one for the direction and one for the speed.

### Setup for Direction Measurement

- ▶ Measurement Type: Analog
- ▶ Analog Type: 0-5A
- ▶ Equation:  $X/VREF * 355$  {converts to degrees}

### Setup for Speed Measurement

- ▶ Measurement Type: Digital
- ▶ Digital Type: Frequency 1 or Frequency 2 (amplified version only)
- ▶ DC high or AC low: AC low level (for unamplified RMYOUNG)
- ▶ Slope:

Wind Speed Units	Slope
m/s	0.098
knots	0.1904
mph	0.2194
kph (km/h)	0.3528

To setup for wind vector measurements, go to section [10.3.6-MEASURE TYPE: WIND.](#)

## 5.20 Connecting Lufft Wind Sensors

Lufft has a family of smart weather sensors capable of measuring a variety of parameters, including wind speed, direction, air temperature, relative humidity, and air pressure. In addition, it is possible to setup the Lufft sensor to automatically perform average and vector average calculations on the wind speed and direction in which case you do not need to use the Wind Measurement type.

The Lufft sensor connects as an SDI-12 sensor to either SDI or RS-485. To set the units use the SDI command aXUu for US units or aXUm for metric. To set the averaging wind averaging interval to 5 minutes use the following SDI command: aXAw+5. See the Lufft Manual Family of Smart Weather Sensors for details.

Use the C or C4 commands to read wind data from the Lufft sensor. The C commands are needed as the Lufft sensor often has more than 9 parameters in its output. The response to the C command may provide different data based on what model is connected. For example, the WS200-UMB provides the following data in response to the C command:

WS200 UMB	
Parameter	Description
0	Wind Speed (avg) *units based on settings in the WS200
1	Wind Speed (max)
2	Wind Direction (vector)
3	Wind Direction (act)
4	Compass Heading (act)
5	Wind Speed (act)
6	Wind Speed (min)
7	Wind Speed (vct)
8	Wind Quality
9	Wind Direction (min)
10	Wind Direction (max)
11	Wind Direction corr (act)

Other Lufft sensors with temperature and other measurements provide the wind speed and direction as parameters 3 (average speed), 4 (max speed) and 5 (vector direction) and 14 (vector speed) with detailed wind information available using C4. Consult the Lufft manual for details.

## 5.21 Connecting Digital Outputs

One digital output line is provided: DOUT#1.

Please see section [12.3 DIGITAL OUTPUT](#) for details.

## 5.22 Connecting Samplers Triggered by Stage

Many samplers can be triggered to collect a sample via Digital output. Connect DOUT#1 to the “trigger” line of the sampler along with ground and program an equation to generate the pulse based on the desired criteria.

For example, to trigger a sample when the stage is > 12.50 feet do the following:

- ▶ Setup a measurement for stage, type to match the sensor you are using
- ▶ Setup a measurement to control the sampler, type: Meta.
- ▶ Set the Index to point to the stage measurement
- ▶ Set the equation to: `OUTPUT(X>12.5,1,1,1000)` for DOUT#1, PULSE, 1000 ms.

## 5.23 Connecting to the Switched Power

A switched power connection SWD#1 is provided. The connection will provide up to 1A of the input power. The setup and software control when the switched power lines are turned on and off.

SWD#1	Turned on during each measurement of Analog/Digital/SDI sensor. Warmup can increase the on time.
-------	--

Starting with version 8.24, more control is available over the switched power lines. By using the command line interface, one may change the default behavior of the switched power lines. the following control options are available:

- ▶ Manual
  - ▶ The line stays off until turned on by command line, an equation function, or Python Script
- ▶ Alarm In Only
  - ▶ The line is turned on when the system goes into alarms. The line stays on until turned off manually.
- ▶ Alarm In And Out
  - ▶ The line is turned on when the system goes into alarms, and turned off when the system goes out of alarms.
- ▶ Sensor Warmup
  - ▶ The line is turned on during sensor warmup. When the system measures Analog, Digital, or SDI-12 sensors with a warmup time, the line is turned on for the warmup duration. It is turned off afterwards.

If the switched power line is used by Python to control a device, make sure to set it to Manual. Below is the command line capture of the settings.

```
SW Power 1 Control = Sensor Warmup, Range (0=Manual, 1=Alarm In Only, 2=Alarm In And Out, 3=Sensor Warmup), Default = Sensor Warmup
```

## 5.24 Connecting Protected Power

The protected power is labeled PROT+12V. This power provides 1A of the main power. XLink always powers this line. It may not be turned off.

Only certain models provide this connection.

## 5.25 Connecting External Modems

You can connect an external modem and use it for remote communications via LinkComm or other communication programs. The modem must be Sutron’s 8080-0005-1B modem with a special configuration saved in its profile. The modem will connect to the RS-232 port via a male-male null modem cable.

Here are the details of how the modem must be configured.

The following table summarizes the AT commands that will be issued:

&F	factory reset the modem
&D0	ignores DTR
&S1	modem asserts DSR when connection established
&K3	enable RTS/CTS hardware flow control
S0=1	auto answer on first ring
S2=255	disable +++ escape (allows binary file transmission)
E0	echo disabled
Q1	disable messages
&W	save the settings to nonvolatile memory of the modem

Connect to the modem with HyperTerminal (or similar) using a PC. For the best performance, connect at 115200, N, 8, 1. The modem remembers the baud rate at the time of the AT&W, so be sure to communicate at the rate you intend to use with XLink. 115200 baud is the default rate, but smart modems can go quite a bit faster.

Here's how to configure a modem (assuming it's at factory defaults):

- ▶ Enter AT and then press ENTER until the modem responds with 'OK'
- ▶ Paste the following command to the modem:
  - ▶ AT&F&D0&S1&K3S0=1S2=255
- ▶ Press ENTER and the modem should reply 'OK'
- ▶ Paste the following command to the modem:

- ▶ ATE0Q1&W
- ▶ Press ENTER

After the modem has been dumbed down by these commands it will not even say 'OK' to an AT command anymore. To see if it's still working you may try a command with a non-simple response such as AT&V

To configure XLink to answer at 115200, USB connect with LinkComm, use the Diagnostics, Terminal window. Press ENTER to get the ">" prompt and issue the following:

- ▶ RS232 Baud Rate=115200

Then reboot the unit for the new baud rate to take effect by issuing the Reboot command or power cycling the unit.

The modem will now automatically answer calls and provide remote communications.

See section [6.3.4-CONNECTING VIA ANALOG MODEM](#) for instructions on how to use LinkComm with the external modem.

## 5.26 Connecting External Cell Modems

You can connect an external cell modem for remote communication via LinkComm or other communication programs. The following details show how to do this using Sutron's GPRS-1-O modem that is preconfigured to operate as a client serial bridge to accept connections and pass data between XLink and the remote caller. The modem will connect to the RS-232 port via a male-male null modem cable.

Follow these steps to configure the GPRS-1-O modem to operate in serial bridge mode.

- 1) Creating/selecting the script. Some readymade scripts are provided based on typical settings and common APNs. Go ahead and use ATT\_script.txt, T-Mobile\_script.txt, or Rogers\_script.txt if you are using either of these providers. Otherwise, contact Sutron for help in creating the proper files for the modem.
- 2) Load the script into a thumb drive. The file must be copied into the station folder and must be renamed with the station as part of the file name. For instance, if the station was named S01, then the file must be renamed "S01\_script.txt"
- 3) Attach the modem to the RS-232 port and insert the thumb drive. Look for a script\_results.txt in the daily sub-folder and examine it for errors. Once the modem is working, enable passwords to help secure the station.

The script is designed to be run on a factory fresh modem or one that's already running the script. The script will switch the speed of the RS-232 port to 115200 baud.

See section [6.3.5-CONNECTING VIA TCP/IP](#) for instructions on how to use LinkComm with the external modem.



## 5.27 Inserting an SD card

The micro SDHC card slot is located on the right side of the unit pictured below (labeled  $\mu$ SD). Please see the [7.16 SD CARD OPERATION](#) section for more information on SD cards.



## 6 Installing and Running LinkComm

---

LinkComm is a software application designed setup and operate XLink. LinkComm is used to:

- ▶ Check status
- ▶ Set up configuration
- ▶ Download and graph the log from
- ▶ Upgrade firmware
- ▶ Calibrate connected sensors

### 6.1 Installing the LinkComm mobile app

Mobile versions of LinkComm are available to run on Apple iPad and iPhone, and on Google Android phones and tablets. They can be found on the Apple® App Store™, and Google® Play Store™, respectively.

### 6.2 Installing the PC version of LinkComm

The PC version of LinkComm is available for download from [HTTPS://WWW.SUTRON.COM/PRODUCT/LINKCOMM/](https://www.sutron.com/product/linkcomm/). The PC version is supported on Windows 7 and higher.

After downloading LinkComm, run the program and follow the instructions on the screen. For Windows, extract all files to a folder on your computer. You may run LinkComm directly from this folder by double-clicking “LinkComm.exe”, or, to *install* LinkComm so that it appears on the Start menu, double-click “setup.exe” (Administrator privileges are required to *install* LinkComm).

If your PC is running Windows 7, you will need to install the USB drivers after installing LinkComm. Note: this is not needed for Windows 8 and beyond.

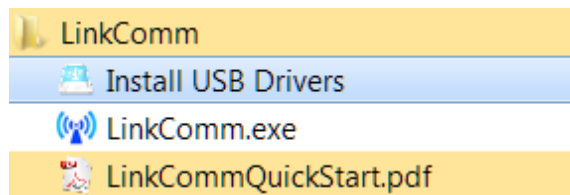

### 6.3 Stations List View

When LinkComm starts, it displays the Stations List View, containing a list of stations that have previously been setup in the software, along with the details of the selected station. The details include the station name, type, connection settings, notes, and images.

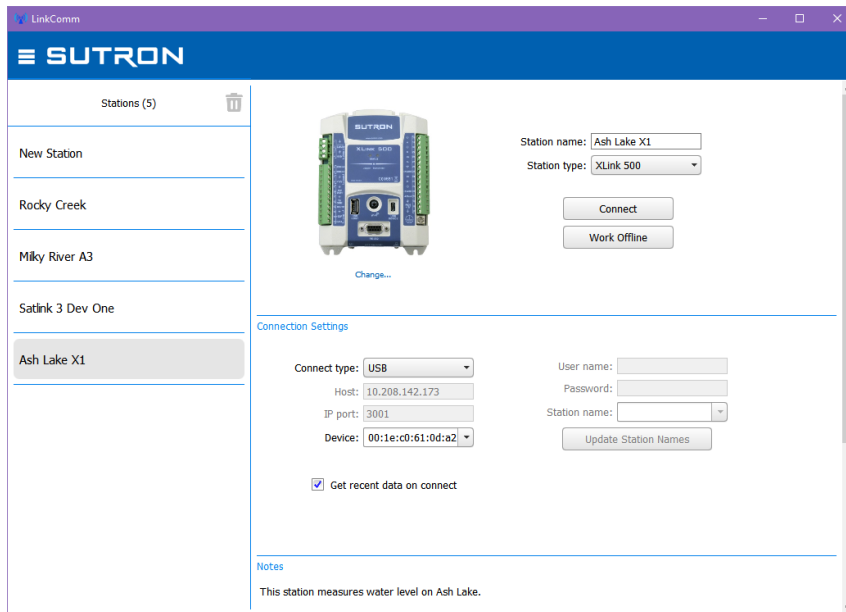

On small displays, the station list is hidden. Press < Stations to see the station list.

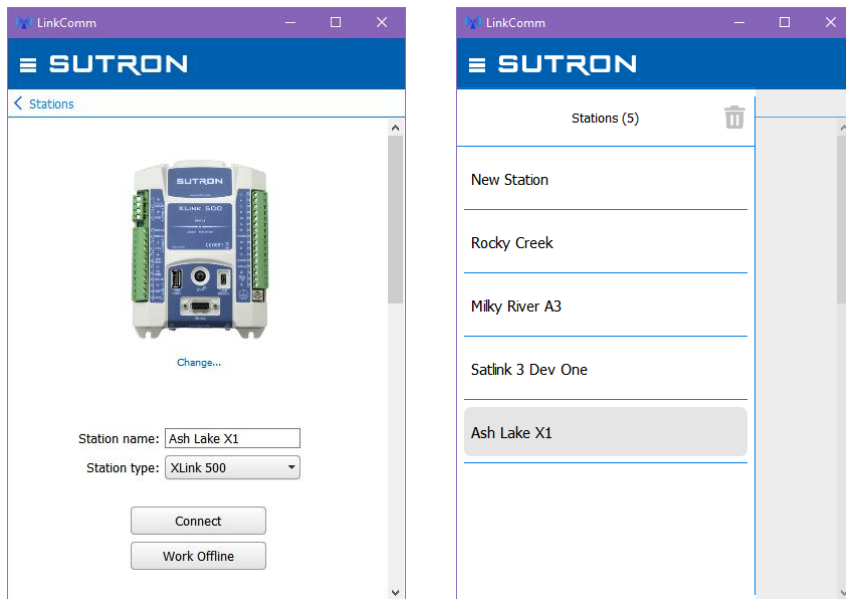

To work with the selected station, press “Connect”. The software will use the assigned connection settings (USB, RS-232, Modem, or Wi-Fi), to try to communicate with the site.

If you have problems connecting to the site, check your communication settings and or cables/Wi-Fi settings and see the following sections that detail USB and Wi-Fi connections.

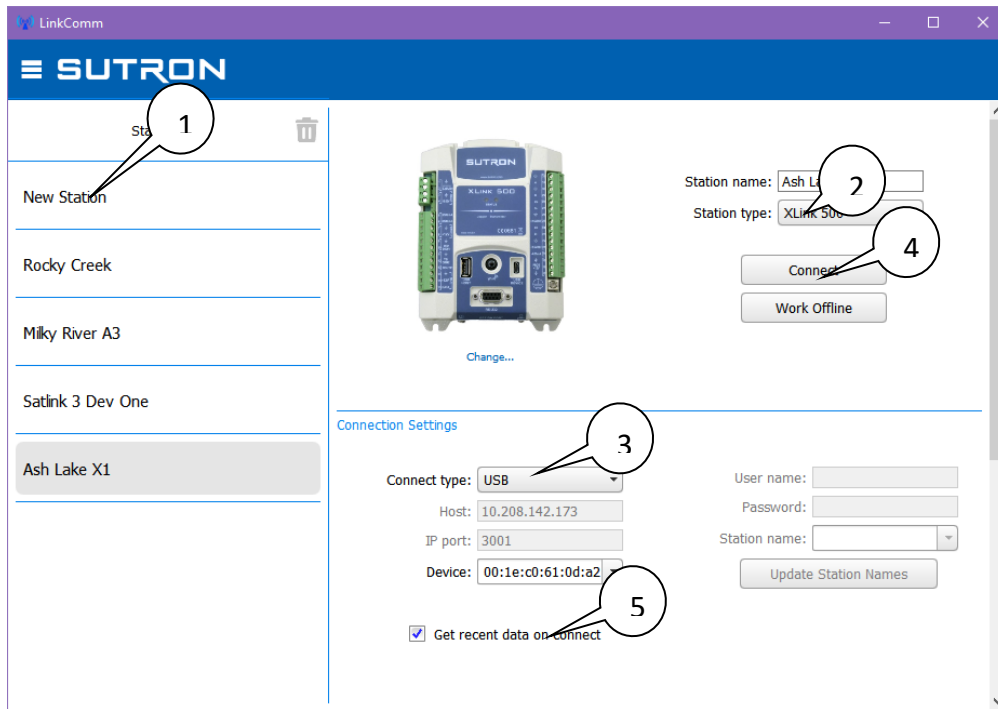

To create a new station, select “New Station” at the top of the station list (1). Then set the Station Type (2) to match your type of XLink, set “Connect type” (3) to Wi-Fi, USB, Serial or Modem, and press Connect (4). Additional information on the Wi-Fi, USB and modem connections are provided in the next sections.

You can set the software to get recent data (5). “Get recent data on connect”, when checked, will cause LinkComm to download the last week of data for display in a graph on the dashboard tab, every time you connect to the station. This can be a considerable amount of data (several k-bytes). You may choose to disable this feature to reduce data costs (e.g., when communicating over cellular links).

The “Check setup on connect” option (visible only for low bandwidth connections like “Redirector”), will cause LinkComm to retrieve the setup from station every time you connect. You may choose to disable this feature to reduce data costs (e.g., when communicating over cellular links).

### 6.3.1 Connecting via USB

LinkComm can connect directly via a USB cable. Connect a USB cable from your computer to XLink and select “USB” as the Connect type.

You will need to pick the appropriate USB device:

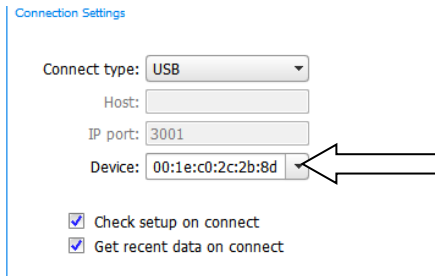

### 6.3.2 Connecting Remotely

LinkComm can also remotely connect to a XLink station if the optional cell modem is installed. To do so, the Listening setting needs to be enabled.

Alternatively, to reduce power consumption, the system can be configured to check for messages periodically. A message can be sent to the station asking it to temporarily turn on listening. Please see section [13-TELEMETRY](#).

#### 6.3.2.1 TCP/IP

If the IP address of a station is known, it can be connected to directly. It is up to cell service provider to

- ▶ Give a static IP address. This means that the IP address of station does not change over time. Alternatively, you may send an SMS to the station asking what its current IP address is.
- ▶ Provide VPN access. It is not always possible to directly connect to the station over the internet because it is protected by the cell service provider’s firewall. In this case, it is necessary to first connect to a VPN provided by the cell service provider.

#### 6.3.2.2 The Redirector

Sutron provides a “redirector” service that can be used to access a station that uses a SIM card provided by Sutron. The IP addresses of these SIM cards are behind a firewall, and so need special steps to be taken for access.

When obtaining one of these SIM cards from Sutron, you will also receive a username, password, and station name to use when setting up your station connection in LinkComm. After entering your username and password, you may press the “Update Station Names” button to retrieve the list of stations that are associated with your redirector account.

### 6.3.3 Connecting via Wi-Fi

XLink can provide a Wi-Fi hotspot that LinkComm can connect to. The Wi-Fi feature is useful for connecting to the station on-site with a mobile phone, tablet, or laptop.

**XLink’s Wi-Fi hotspot is not connected to the internet.**

To connect via Wi-Fi, follow this sequence:

- ▶ Have the station turn on the Wi-Fi by pushing the wakeup button located on the front. The station will blink the blue halo LED to acknowledge the button press.
- ▶ Have your computer (Laptop, iPhone, or Android) connect to the Wi-Fi hotspot.
- ▶ XLink will name its hotspot *XL2\_xxxx\_aaaa*, where *xxx* is the station name, and *aaaa* is a unique number.
- ▶ Create a new station in LinkComm with “Connect type” set to “Station Wi-Fi” (LinkComm may detect you are connected via Wi-Fi and set this type by default)
- ▶ If you need to manually enter the IP address for XLink, it is 192.168.88.1:3001.
- ▶ LinkComm is now connected to the station. It is possible to check status, change setup, download log, and perform almost all other operations.
- ▶ Once the LinkComm session is complete, make sure to disconnect from the Wi-Fi hotspot.



**In order for LinkComm to connect to XLink via Wi-Fi, the device that is running LinkComm must first connect to the Wi-Fi hotspot provided by XLink.**

Here’s an example mobile Wi-Fi Settings screen showing several devices available for connection:

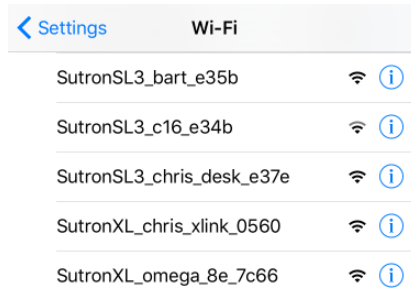

### 6.3.4 Connecting via Analog Modem

LinkComm can connect to a station with an external modem via a telephone modem. Connect the modem to your computer, select the “Modem” Connect Type, and enter COM port. Press the “...” button to enter phone number and other modem details. Note, LinkComm expects the modem to support ASCII result codes (“OK”, “CONNECT”, etc.), and DTR call control.

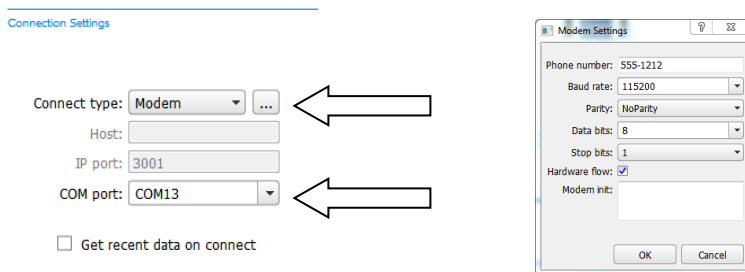

### 6.3.5 Connecting via TCP/IP

LinkComm can connect to a station with an external Cell modem via TCP/IP. See section [5.26-CONNECTING EXTERNAL CELL MODEMS](#) for instructions. LinkComm will need to be run on a device that has access to the same network that the modem is operating on. If the modem is on a private network, the PC will need VPN access to that network.

- ▶ Select Connect type: TCP/IP
- ▶ Enter URL or IP address for the station
- ▶ Make sure that the IP port matches the port you have enabled in the modem (usually 3001).
- ▶ Press Connect

Connect type:

Host:

IP port:

COM port:

### 6.3.6 Working Offline

To “work offline” means to make changes to the setup in LinkComm setup while disconnected from the station. You enter this mode by selecting “Work Offline” in the station view. The changes you make to the setup are automatically saved in LinkComm but not in the station.

When you later connect to the station, you need to send the setup to the station to bring the setups “in-sync”. If you checked “Get setup on connect” in the station’s Connection Settings, then when you first connect, LinkComm will prompt to overwrite your changes. If you answer “No”, LinkComm will then prompt to send your changes to the station. Answer “Yes” at this point to bring the setups “in-sync”.

### 6.3.7 Notes

This section is used to enter notes in this section related to station setup and maintenance. For example, you might store information about the last time the station was visited, plans for future visits, and notes on calibrations, etc.



**Note: All settings (station and connect settings, notes, and site images) for every station you define are saved automatically as you make changes. Hence, there is no need to select any kind of “Save” menu item.**

### 6.3.8 Site Images

This section allows you store pictures of the site. Click “Add New Image” to browse for images to store. If a camera is available, you’ll have the option to take pictures to store as new site images.

When you click a site image, it expands to fill the available window.

To delete a site image, right-click (or press-and-hold) the image and select “Delete Site Image” in the subsequent prompt.

## 6.4 Main Menu

Press the  button in the upper left to access the main menu. The menu shows different options, depending on whether you are connected to – or working offline with – a station.

The following menu is displayed in the Stations List View:

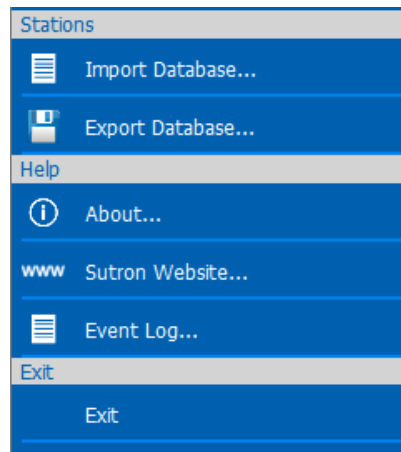

Import Database...	Import a stations database previously saved using “Export Database...” Note that this will overwrite all existing station definitions with those from the imported database. The action cannot be undone., You may want to export the current database, just in case you need to restore it
Export Database...	Export all station definitions to a database file. You can then use “Import Database...” on another PC or mobile device to import the station definitions.
About...	Display a dialog showing information about LinkComm, including version
Sutron Website...	Visit the Sutron website
Event Log...	Show LinkComm event log. This is a text file showing diagnostic information about LinkComm operation.
Exit	Exit and close the LinkComm application. This item is not displayed when running on mobile platforms



The following menu items are displayed in Station Detail View (i.e., when connected or working offline):

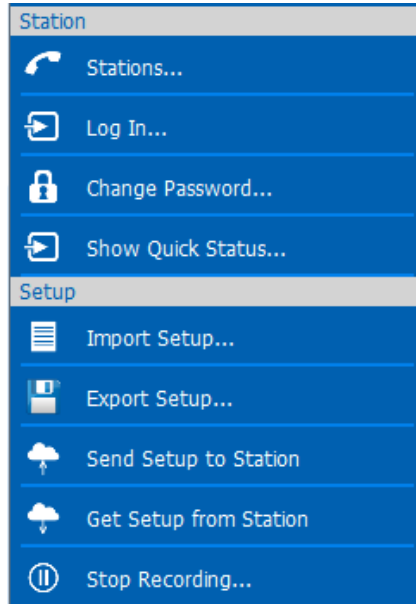

Stations...	Disconnect and return to the Stations List View
Log In...	LinkComm prompts for password and then attempts to log in to the station
Change Password...	LinkComm prompts for new password to use to log in to the station
Show Quick Status...	Show the Quick Status dialog, showing a summary of station status
Import Setup...	Load a setup from an external file. The setup file was typically saved by a prior "Export Setup..." action
Export Setup...	Save the current setup to an external file. The setup file is a text file containing property-value assignments
Send Setup to Station	Send the current setup to the station (shown only if connected)
Get Setup from Station	Get the setup from the station (shown only if connected)
Stop Recording	Start (or Stop, if applicable), recording (shown only if connected)

## 6.5 Station View

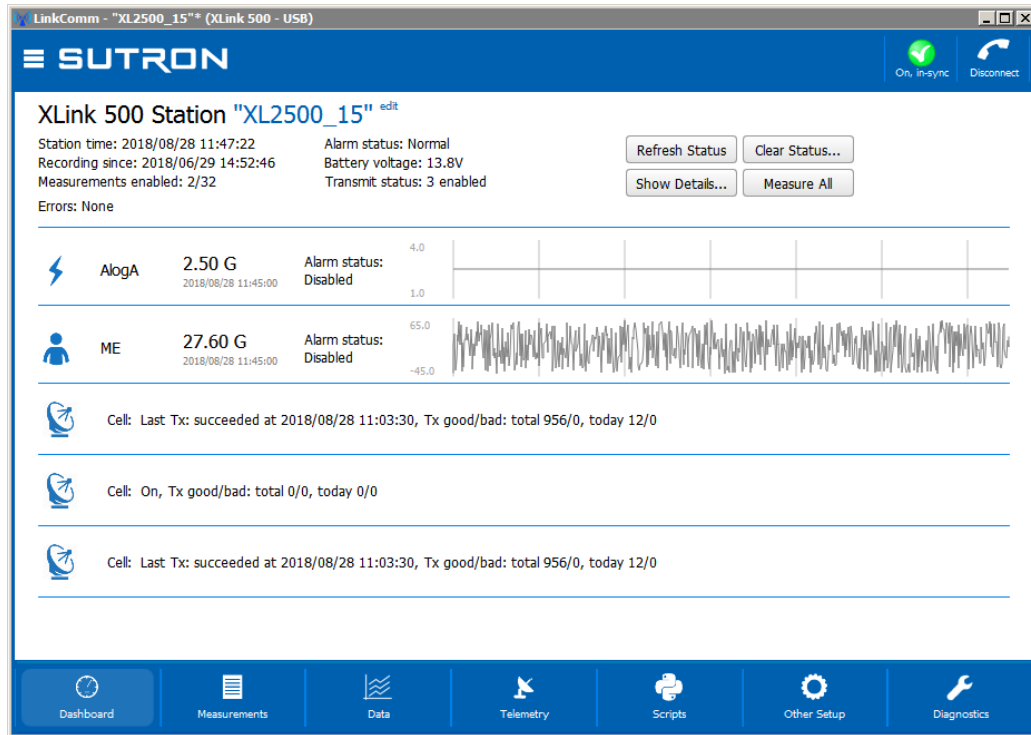

After you press either “Connect” or “Work Offline” in the stations list view, LinkComm transitions to the “Station View”, where you see several tabs, e.g., Dashboard, Measurements, Data, etc., each showing information about status and/or setup for the selected station.

The following picture is of the station view with the Dashboard tab selected:



### 6.5.1 Connect Button

The right header button is the “Connect Button”. It shows the status of the current connection from LinkComm to the station. The button has two possible states:

	<p>LinkComm is connected to the station</p>	<p>Pressing the button in this state will cause LinkComm to disconnect from the station</p>
	<p>LinkComm is not connected to the station</p>	<p>Pressing the button in this state will cause LinkComm to try to connect to the station</p>

### 6.5.2 Setup Status Button

The left header button is the “setup status button”. This button shows status related to the setup, including whether the setup is “in-sync”, i.e., the same in both LinkComm and the station, and recording status.





Pressing the setup status button typically prompts the user to take the next logical step towards getting the setup in-sync between LinkComm and the station, with recording on.

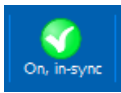

**Note: When the setup displayed by LinkComm is the same as the setup in the station, then we say the setups are “in-sync”. When the setups are not the same, the setup status button displays a warning sign, and you must send the setup to the station to get the setups “in-sync”.**

After making changes to the setup locally, you need to send those changes to the station to bring the setups “in-sync”. You do this by pressing the setup status button (or by selecting the main menu item, “Send Setup to the station”).

The following table describes the different states maintained by the setup status button, and describes what happens when you press the button in each of the states:

	<p>LinkComm is connected to the station, recording is ON, and the setups are “in-sync”</p>	<p>Press the button to turn off recording. LinkComm will prompt for confirmation.</p>
	<p>A change has been made to the setup in LinkComm (it no longer matches the setup in the station)</p>	<p>Press the button to send setup changes to the station. LinkComm will prompt for confirmation. If “Yes”, only the changes required to be “in-sync” are sent. If “No”, LinkComm prompts to retrieve the setup from the station, overwriting local changes</p>
	<p>The setup in the station is unknown, and so may differ from the one displayed by LinkComm</p>	<p>Press the button to send the setup to the station. LinkComm will prompt for confirmation. If “Yes”, LinkComm first sets the setup in the station to defaults, and then sends the changes required to be in sync</p>
	<p>Recording is OFF in the station. This means no</p>	<p>Press the button to turn recording ON in the station. LinkComm will prompt for confirmation</p>

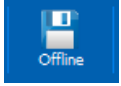
	measurements are being made	
	LinkComm is working offline (not connected to the station)	Press the button to connect to the station



**The setup that is shown in LinkComm is not necessarily the same setup that is in a connected the station**

- ▶ To read a setup from the station and show it in LinkComm, you may either use the [SETUP STATUS BUTTON](#) as described in the previous section, or select the **Get Setup From the station** item from the main menu
- ▶ To give a setup created by LinkComm to the station, you may either use the [SETUP STATUS BUTTON](#) as described in the previous section, or select the **Send Setup To the station** item from the main menu



**Unless the [SETUP STATUS BUTTON](#) menu item is selected, or the **Send Setup to the station** button is clicked, none of the changes made to the setup in LinkComm will be in the station!**

### 6.5.3 Handling Setup Differences Following Setup Send

On some occasions, LinkComm will detect that differences remain after sending setup changes to the station. This can happen because of a communication error, but more commonly, it occurs because the station doesn't allow certain changes to occur remotely.

In any case, when LinkComm detects such a difference exists, LinkComm warns you that changes still exist, and will offer a dialog to "View Differences". To rectify the situation, it is usually best to get the setup from the station to again be "in-sync", and then try making and sending your changes again.

### 6.5.4 Setup Files

You can save a station setup to a file and later re-use that setup by loading it into LinkComm. To save a station setup to a file, select **Export setup...** from the main menu.

You may find it helpful to save reference copies of setups outside of LinkComm, as a backup in case you accidentally overwrite changes to the setup in LinkComm. Use the export setup menu item to achieve this.

To load a station setup from a file, select **Import setup...** from the main menu. After loading the setup file, you still need to send the changes to the station. As always, use either the [SETUP STATUS BUTTON](#), or the **Send Setup to Station** menu item, to send the setup to the station.

### 6.5.5 Metadata - Pictures, Wiring Diagrams, and Special Text

LinkComm enables you to associate pictures, wiring diagrams, and special text items with your station definitions. This “metadata” is NOT stored in the station, since the station needs to use its storage space for more important things like sensor readings.

Some examples of metadata in LinkComm:

- ▶ Station picture, notes, and site images
- ▶ Measurement picture, model, manufacturer, description, units

This station metadata is **not** stored in the station setup files created by **Export Setup....** The metadata is saved, however, when saving the stations database using the **Export Database...** menu item from the Station View main menu.

## 6.6 Dashboard Tab

The Dashboard tab is the first tab displayed after you connect to a station. It shows an overview of the station, including

- ▶ Station status
- ▶ All active measurements, their last readings, and alarm status
- ▶ A graph of recent measurement data (if *Get recent data on connect* was checked). Right-click to refresh the data.
- ▶ All enabled transmissions, along with information on the transmission time and counts
- ▶ All active script tasks along with their status

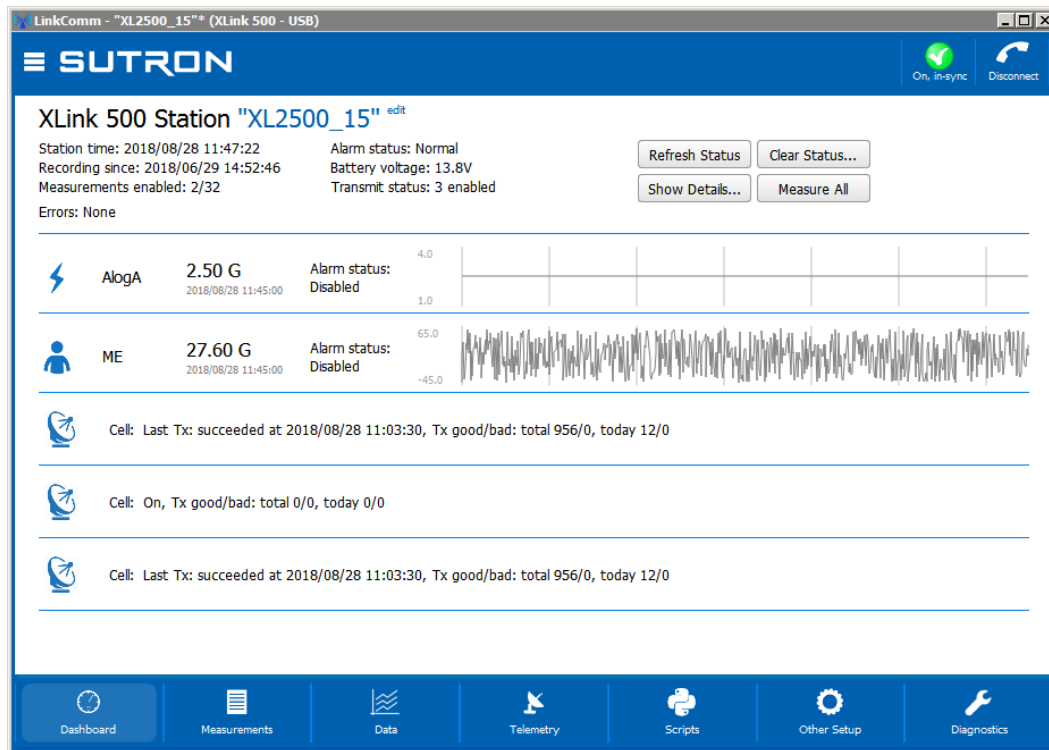

- ▶ To refresh the current status, click the **Refresh Status** button
- ▶ To reset the station status, including the transmission counters, tallies and system errors, click the **Clear Status** button. Once the status is reset, the previous status is lost
- ▶ To show the status text actually received from the logger, press the **Show Details** button
- ▶ To measure and update all sensors, press **Measure All** button
- ▶ High-level telemetry status is also shown on this page (below current sensor values). To see low-level details about telemetry, see the Telemetry tab.
- ▶ If the station has any active errors, these are shown in RED just below the status area.

Right-clicking on any trend graph (or touching the graph in the mobile app), reveals a pop-up menu that allows you to:

- ▶ Refresh recent data (all items, not just the selected)
- ▶ View the current data item in the larger graph on the Data tab

### 6.6.1 Changing the Station Name

The station name can only be changed from the Dashboard tab, and is actually the *only* setup item that can be changed from the Dashboard tab. To change the station name, press the blue "edit" text, next to the station name.



LinkComm will prompt for the new station name. Just as with every other station setup change, the change is not complete until you have sent the setup to the station. Do this using either the [SETUP STATUS BUTTON](#) in the main header, or the **Send Setup to the station** item in the main menu.

## 6.7 Measurements Tab

The measurements tab is the first tab displayed when you select **Work Offline** in the stations list view. This is the tab where all sensors are configured. Up to 16 sensors may be enabled and configured. The measurements tab also provides some test functions to help you ensure the sensor is properly configured.

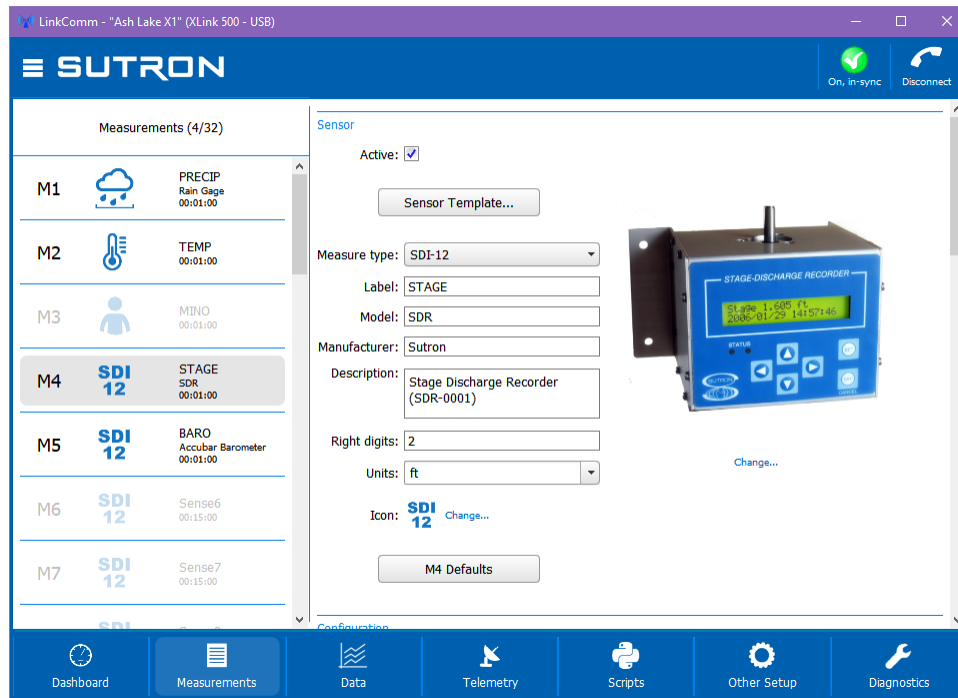

The left side of the measurements tab shows a list of all possible measurements. The right side of the measurements tab shows the details of the selected measurement. The details are the settings used to

determine how the measurement is taken and how the data is processed by the system. The settings include schedule, Configuration (including wiring diagram), Processing, Alarms, Logging, Tx Content.

## 6.8 Data Tab

The data tab shows historical measurement readings made by the station. If recent data was downloaded when connecting to the station, the graph displays this data the first time you select the Data tab.

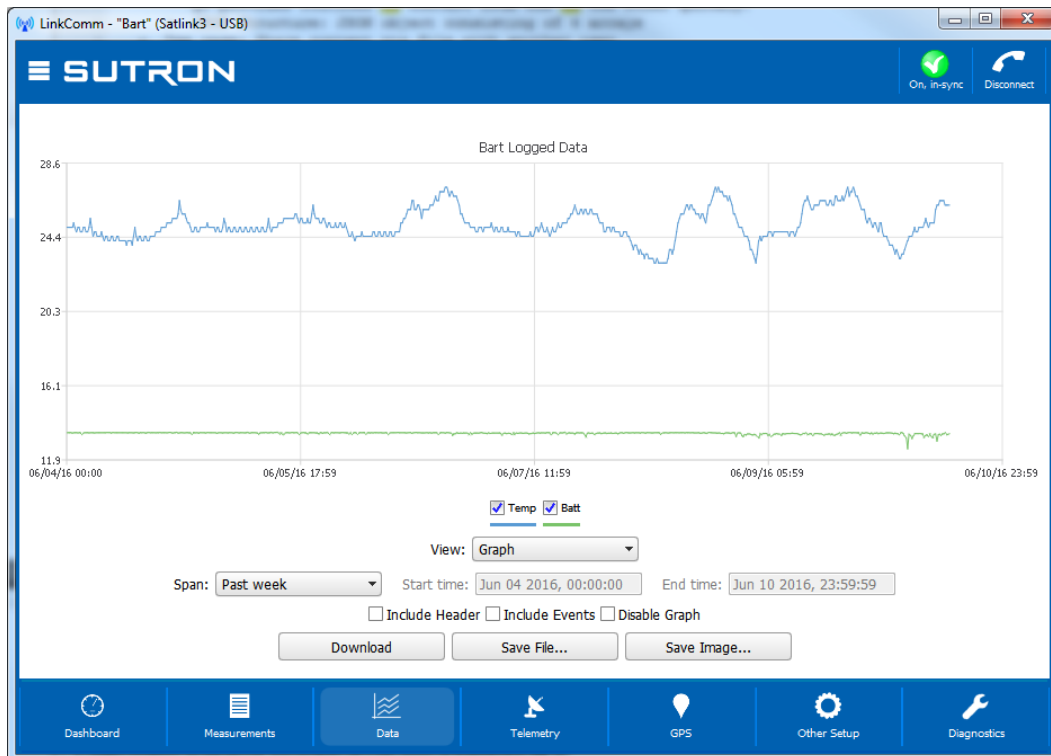

To zoom-in on subsets of data, click-and-drag to create a rectangle around the data you want to zoom to. To restore the zoom to all data, double-click. When using a touchscreen, you may use your finger to draw the rectangle, and double-tap to reset the zoom.

Right-clicking (or touching) the graph will show a menu allowing you to select all series, deselect all series, or show points. You may select or deselect individual data series for display using the legend just below the graph.

Change the span of the period to graph using the **Span** control. Several options are available. Whenever a change to span is made, you must press the **Download** button to retrieve the data for display. When the defined span no longer matches the displayed span, the download button text changes to "Download\*\*\*".



Press **Save File...** to save the raw data to a text file. Press **Save Image...** to save an image of the graph to disk. On mobile platforms, rather than save files to disk, you are prompted to “share” the files via other services like Email, Dropbox (if installed), etc.

Change **View** to **Table** to see a table view of the data, rather than a graph.

Enabling **Disable Graph** causes the graph (or table) view to remain empty while data is being downloaded. This can improve performance for very large downloads.

## 6.9 Telemetry Tab

The Telemetry tab is used to configure a station for Iridium or Cellular communications. The contents of the tab differ for each telemetry type.

Telemetry tab showing Cell setup:

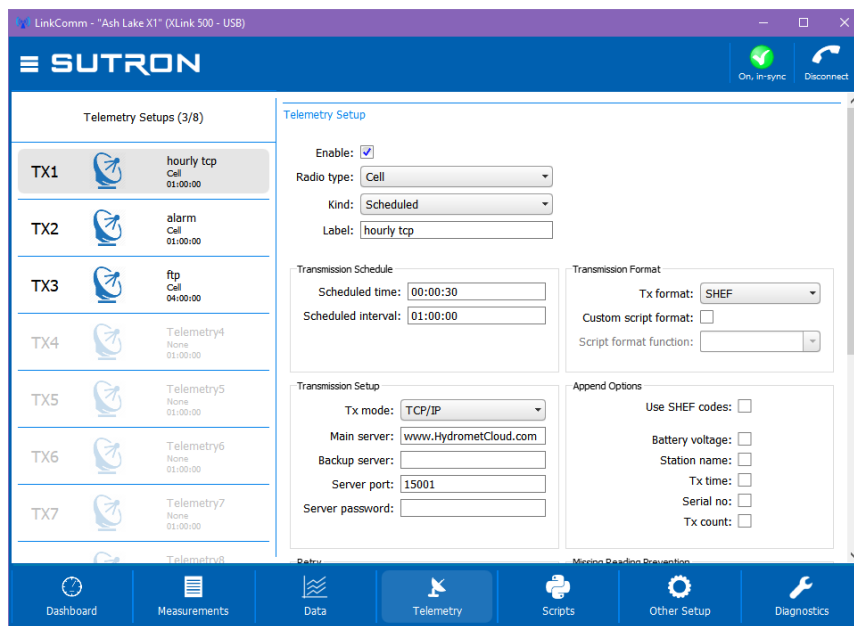

The telemetry status section is below the setup area, and is accessed by scrolling down.

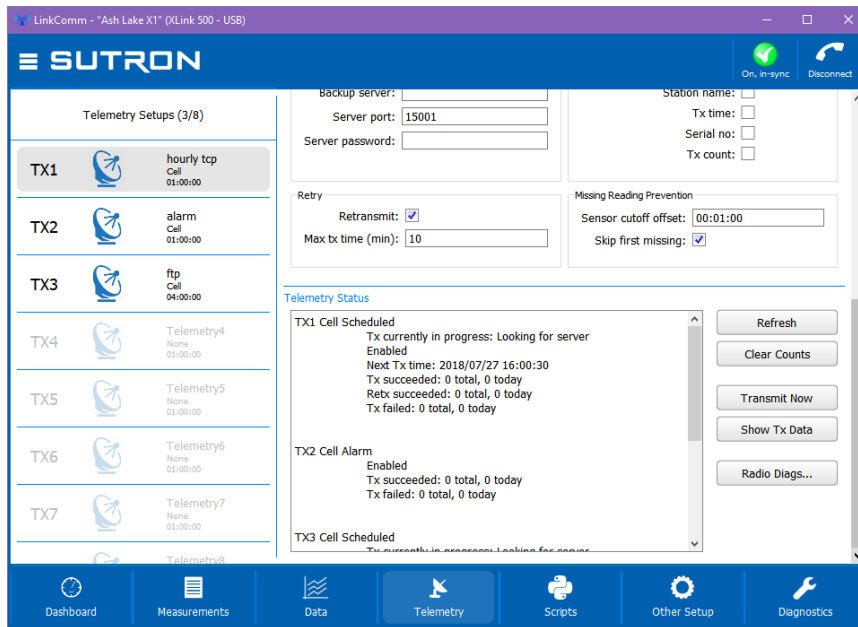

The status text is retrieved from the station the first time you display the telemetry tab and can be refreshed as needed on demand.

Please see section [13 TELEMETRY](#) for more info.

### 6.9.1 Radio Diagnostics

Iridium and Cell Telemetry types offer a Radio Diags button which provides diagnostics information on the modems. Please see section [6.12 DIAGNOSTICS TAB](#).

Information provided includes signal strength, time when the modem last connected to the network, contents of the last received message, and IMEI.

Besides showing the diagnostic information, the Radio Diagnostics tab allows one to check for Iridium messages immediately, and to send an SMS to a specific cell number.

## 6.10 Scripts Tab

This window is used for general script management as well as setting up individual script tabs.

Please see [20 SCRIPTS](#) for more details on working with scripts.

By clicking on Script File Details, the script management window provides an overview of the script file used as well as of all the script functions. If a script is in use by the system, that information is shown.

The script itself can be seen and edited on this window. Script testing options are found here too.

**SUTRON** Changed Disconnect

**Scripts**

Script File Details  
6 functions available  
6 functions used  
4 tasks active

- S1 rs232\_last\_meas ScriptTask1 00:01:00
- S2 alarm\_in\_change ScriptTask2 Alarm In Only
- S3 alarm\_out\_chang ScriptTask3 Alarm Out Only
- S4 trigger\_sampler ScriptTask4 00:05:00
- S5 ScriptTask5 04:00:00
- S6 ScriptTask6 04:00:00

File name: Script.py  
File size: 2432  
CRC: 0x8b9617b1  
Functions Available:

Function Name	Type	Usage
rs232_last_meas()	Task	S1
minutes_of_daylight(pv)	Measurement	M1
append_info(standard)	TxFormat	TX1
alarm_in_change()	Task	S2
alarm_out_change()	Task	S3
trigger_sampler()	Task	S4

Missing Functions:

Function Name	Type	Usage
dew_point	Measurement	M5

Script Text

```

from s13 import *
import serial

@TASK
def rs232_last_meas():
    """
    This RS232 example shows how to output the last value
    of measurement M1 in CSV format.
    Example::

        08/05/2017,17:01:40,BATT,13.156,V,G
    """
    with serial.Serial("RS232", 9600) as out:
        output.write(str(measure(1, READING_
        output.flush() # make sure all the

"""this variable counts the minutes of daylight
m_daylight = 0.0

@MEASUREMENT
def minutes_of_daylight(pv):
    """
    This program counts minutes of daylight
    The following measurement setup configura
    
```

Open Script File... Remove Script File...  
Save Script File As... Test Script File...

Dashboard Measurements Data Telemetry GPS Scripts Other Setup Diagnostics

By choosing one of the script tasks available (marked as S1, S2, etc. on the left-hand side), the details of the script task are shown. This window is used to configure the script tasks.

**SUTRON** Changed Disconnect

**Scripts**

Script File Details  
6 functions available  
6 functions used  
4 tasks active

- S1 rs232\_last\_meas ScriptTask1 00:01:00
- S2 alarm\_in\_change ScriptTask2 Alarm In Only
- S3 alarm\_out\_chang ScriptTask3 Alarm Out Only
- S4 trigger\_sampler ScriptTask4 00:05:00
- S5 ScriptTask5 04:00:00
- S6 ScriptTask6 04:00:00

Active:   
Label: ScriptTask1  
Script function: rs232\_last\_meas  
Trigger: Scheduled  
Scheduled time: 00:00:00  
Scheduled interval: 00:01:00  
S1 Defaults...

Script Text

```

@TASK
def rs232_last_meas():
    """
    This RS232 example shows how to output the last value
    of measurement M1 in CSV format.
    Example::

        08/05/2017,17:01:40,BATT,13.156,V,G
    """
    with serial.Serial("RS232", 9600) as output:
        output.write(str(measure(1, READING_LAST) + "\r\n")
        output.flush() # make sure all the data is sent before closing the port.
    
```

Test Script Task...

Dashboard Measurements Data Telemetry GPS Scripts Other Setup Diagnostics

## 6.11 Other Setup Tab

Various settings are displayed in the Other Setup dialog, which is accessed from the Telemetry tab by pressing the **Other Setup** button. The settings shown include those for:

- ▶ Wi-Fi
- ▶ Log daily values
- ▶ DCP Command
- ▶ Digital Output DOUT
- ▶ Optional Card Setup
- ▶ Programmable Voltage References
- ▶ Iridium Modem Settings
- ▶ Cell Modem Settings
- ▶ Modbus Settings
- ▶ Log Download Format

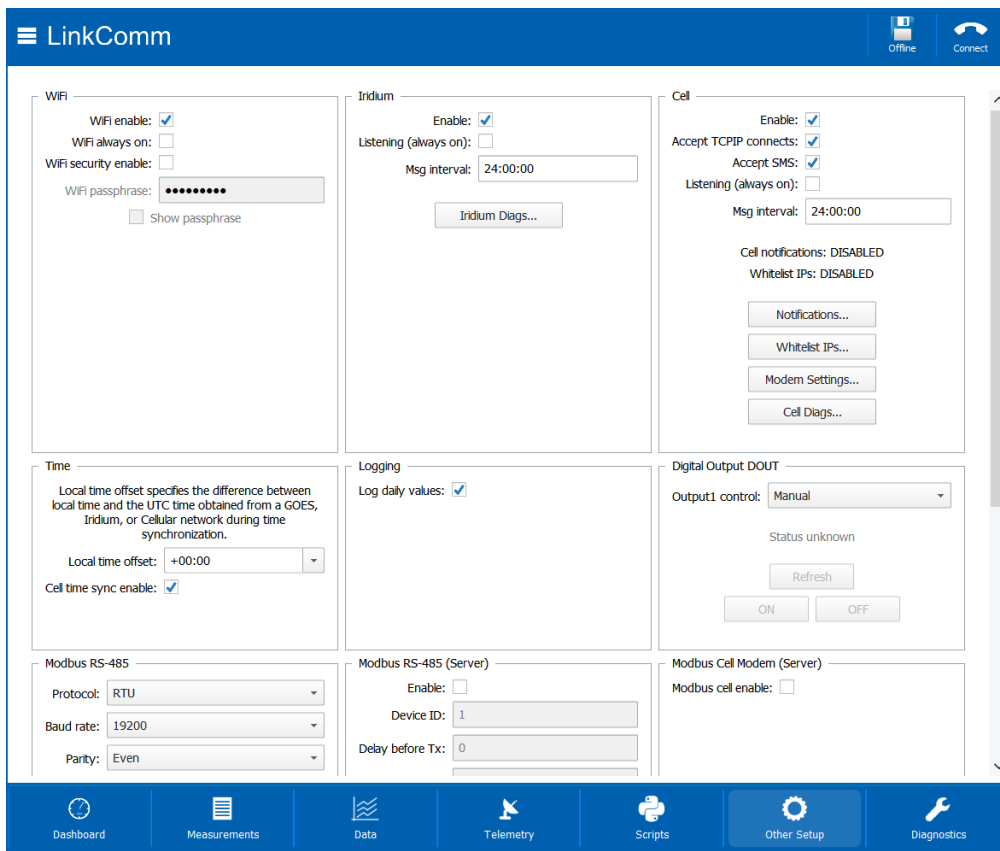

See section [12 OTHER SETUP](#) for more information setting in this page.

Iridium and Cell Telemetry types offer Iridium Diags and Cell Diags buttons which provides diagnostics information on the modems. Please see section [11.5.5 RADIO DIAGS](#) for details.

## 6.12 Diagnostics Tab

This tab provides extensive diagnostics information and offers tools for performing various diagnostics and maintenance operations. For example:

- ▶ Get diagnostics information including software versions and data usage
- ▶ Terminal and Data Flow views
- ▶ SDI-12 command utility
- ▶ Set the station clock
- ▶ Upgrade station Firmware
- ▶ Resetting station to factory defaults

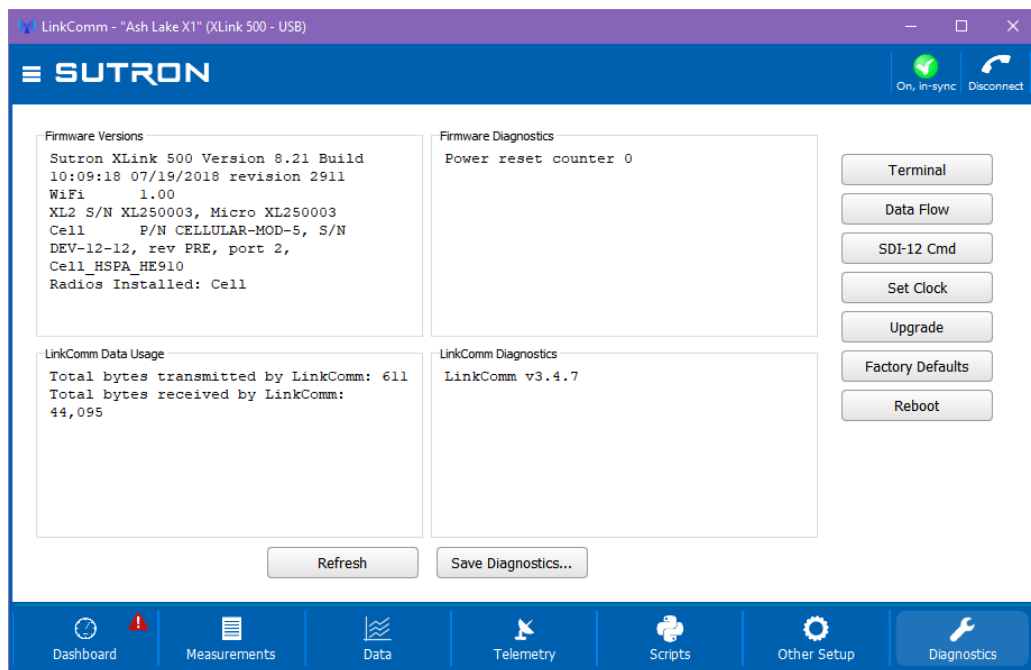

### 6.12.1 Firmware Versions and Diagnostics

The top two text areas on the Diagnostics tab display information about the firmware installed in the connected station.

The **Firmware Versions** section displays the current versions of firmware installed in the station. If LinkComm detects a newer version of firmware is available, this text area contains a message saying such. The **Firmware Diagnostics** area displays recent diagnostics information reported by the station.

Press the **Refresh...** button to update this data to the latest. Press the **Save to file...** button to save all diagnostic text data to an external file.

### 6.12.2 LinkComm Versions and Diagnostics

The bottom two text areas on the Diagnostics tab display information about LinkComm.

The **LinkComm Data Usage** section displays the total byte counts between LinkComm and the station for the current session. The LinkComm Diagnostics section displays LinkComm's version information.

Press the **Refresh...** button to update this data to the latest. Press the **Save to file...** button to save all diagnostic text data to an external file.

### 6.12.3 Terminal

LinkComm features a built-in terminal monitor program. All communications between LinkComm and the station uses the command line interface. The Terminal window can be used to view a history of command traffic, and can be used to access the command line interface directly.

To see the details of the communication between LinkComm and the station, bring up the terminal window via the **Terminal** button on the Diagnostic tab.

You may type into the terminal window. Data typed will be sent to the station. Any replies from the station will be shown in the Terminal window.

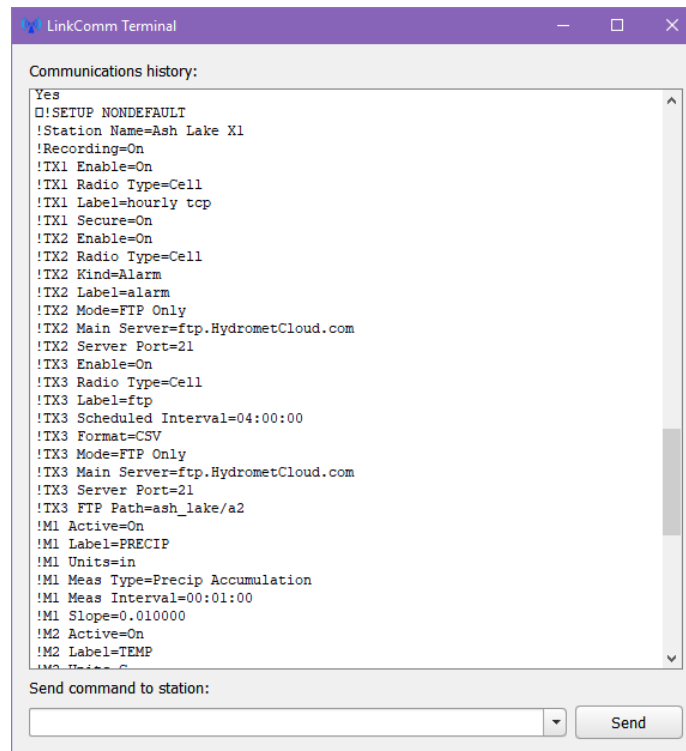

#### 6.12.4 Data Flow

The Data Flow dialog shows recent command line traffic in Hexadecimal and shows traffic direction and timestamp information. To open the dialog, press the **Data Flow** button on the Diagnostic tab.

When “Autoscroll on data” is checked, the window advances when new data becomes available.

#### 6.12.5 Firmware Upgrade

The software running in the station can be upgraded. The latest version of firmware is delivered as part of the LinkComm download package obtained from the Sutron web site. LinkComm may be downloaded from <HTTPS://WWW.SUTRON.COM/PRODUCT/LINKCOMM/>.

Upgrades may be done over RS-232, USB, USB thumb drive, or Wi-Fi.

Upgrade files are packaged into the same download with the LinkComm program. Upgrade files will have names such as *XL2EuropaActual\_821r5000.xl2u*

To initiate an upgrade of your station’s firmware, select the **Upgrade** button on the Diagnostics tab. If LinkComm detects a newer version of firmware on your PC, LinkComm will suggest that an upgrade be made using it. If you select “No”, then use the file-open dialog that follows to browse for, and select, the upgrade file to use.

You can also upgrade the firmware via USB drive. See section [7.15.3 UPDATE THE FIRMWARE VIA USB THUMB DRIVE](#).

#### 6.12.6 Setting to Factory Defaults

Setting the station to factory defaults will permanently erase all setup and status. The setup will be set to defaults. To set the station to factory defaults, press the **Factory Defaults** button on the Diagnostics tab and answer “Yes” to the prompt for confirmation.

#### 6.12.7 Rebooting

Clicking the **Reboot** button on the Diagnostics tab will have LinkComm issue the reboot command to the station. The station will perform a software reset. LinkComm will then disconnect from the station.

If you are issuing the command remotely, please note that the station will need a minute to get back on the internet before it is ready to talk again.

### 6.13 Password Menu

LinkComm provides Password related items in the menu that can be used to log in, change the password, and log out. LinkComm will prompt for a password when it is needed.

For details on password operation, please see section [8.2 PASSWORD Protection](#).

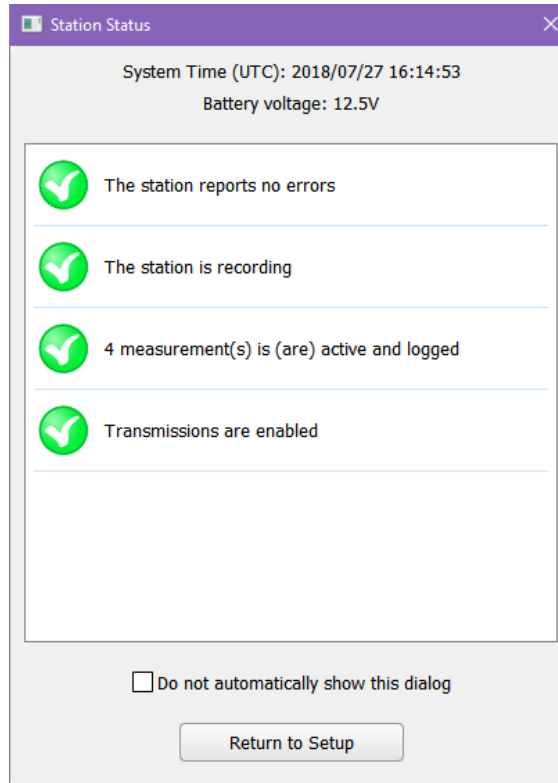

## 6.14 Quick Status Dialog

When disconnecting from a station, LinkComm displays a Quick Status dialog, containing a summary of important status information.



The dialog displays system time and battery voltage information at the top. The scrollable list of status items in the center of the dialog display status for particular items, as follows:

- ▶ Errors
- ▶ Recording status
- ▶ Measurement status, including number of parameters to transmit
- ▶ Scheduled transmission status
- ▶ Random transmission status

	A green check signifies the item is in the expected state
	A warning triangle signifies the item isn't as expected, and may need attention



 A red octagonal stop sign with the word 'STOP' in white capital letters.	A red stop sign signifies the item is likely incorrect, and needs attention
--	---

You can prevent the dialog from being shown when disconnecting by checking **Do not automatically show this dialog**. To see the dialog when this is checked, select **Show Quick Status** from the main menu.

## 7 Operating XLink

---

The following scenarios describe how to perform some common functions with an XLink station. They assume that the station is powered up and that LinkComm is running and can connect to the station via USB, RS-232, or Wi-Fi. For help connecting to a station, refer to [6.3.1 CONNECTING VIA USB](#) or [6.3.3 CONNECTING VIA WI-FI](#).

### 7.1 Creating a New Station in LinkComm

- ▶ Select “New Station” from the top of the station list.
- ▶ Set station type to the correct XLink model, and change connect settings as needed.
- ▶ Press “Connect” (or “Work Offline”, if the station is not connected).
- ▶ On the Dashboard tab, edit the station name.
- ▶ Use the Measurements and Telemetry tab to make other settings (consider using Factory Defaults on Diagnostics tab to start from a blank slate).
- ▶ Select “Save Station” from the main menu. The station will be added to the station list.

### 7.2 Connecting to a station in Your Station List

- ▶ Select the station in the station list.
- ▶ Update the connection type and related settings, if needed.
- ▶ Press “Connect”.
- ▶ LinkComm will read the setup from the station and report any differences it finds. If no message is displayed, the setups match.
- ▶ If the setup differs, a message will be displayed. Press “View Diffs...” to see the differences. Then press YES to send the LinkComm setup to the station, or NO to have a chance to use the setup received from the station as the correct setup.

### 7.3 Importing Setups From Another User Or Station

- ▶ Create or connect to a station, following the steps above.
- ▶ Select “Import Setup ...” from the main menu.
- ▶ Locate the desired setup file and press Open
  - ▶ Note, the setup file is a .txt file and it may have been created via Export Setup, or Diagnostics.
- ▶ If prompted that LinkComm will “replace the current setup...Continue with import?”, select YES. The setup is now resident in LinkComm.

### 7.4 Testing Measurements

- ▶ Go to the measurements tab.
- ▶ Select a measurement

- ▶ Scroll to the Processing Section
- ▶ Press Refresh to view last measurement
- ▶ Press Force to make a new measurement.

## 7.5 Examine Measurements

- ▶ Go to the Dashboard
- ▶ Press “Refresh Status” to see latest data from each measurement
- ▶ Right-click and select “Refresh recent data” to update graphs.

## 7.6 Examine Transmissions

- ▶ Go to Dashboard
- ▶ Select “Show Details”. Statistics on the transmissions will be displayed
- ▶ You may also see the telemetry statistics on the Telemetry tab, Telemetry Status section.

## 7.7 Examine Transmission Data

- ▶ Go to Telemetry
- ▶ Select “Show Tx Data”. The data from the last transmission is displayed along with data that would be transmitted if one were made now. Details on the size and time required to transmit are also displayed.

## 7.8 Entering Manual Data

- ▶ Go to Measurements
- ▶ Select the desired measurement
- ▶ Scroll to Processing, select “Calibrate”, and enter the desired value and press OK.

## 7.9 Calibrating Sensors

- ▶ Go to Measurements
- ▶ Select the desired measurement
- ▶ Scroll to Processing, select “Calibrate”, enter the desired sensor reading and press OK.
- ▶ Whenever a sensor reading is calibrated, the system will log two events – the value before and the value after the calibration.
- ▶ If the Tx Data Content is set to Last, calibrated values will be transmitted.

## 7.10 Configuring SDI-12 Sensors

- ▶ Go to Measurements
- ▶ Select the desired measurement of an SDI-12 sensor

- ▶ Scroll to Configuration and press “Send SDI-12 Command”. A menu will be provided that allow you to select address, commands, and other SDI-12 details.
- ▶ If the desired command is not in the Command drop-down list, simply enter it yourself in the command box.
- ▶ You may also access the SDI command menu from the Diagnostics tab.

## 7.11 Downloading Log Data

- ▶ Go to Data
- ▶ Select desired “Span” and press “Download”.
- ▶ When download is complete, press “Save File...”. Note the file is named by the end time in the span.

## 7.12 Viewing/Clearing the Status

- ▶ Go to Dashboard
- ▶ The status is displayed in the top left giving the station name, time, number of measurements enabled, errors, alarm status, battery voltage, transmission status.
- ▶ Press “Refresh Status” to update the status.
- ▶ Press “Show Details” to see additional information.
- ▶ Press “Clear Status” to clear any errors.

## 7.13 Software Version

You can find the version of the software on the diagnostics tab of LinkComm. The Serial Number of the product is listed there as well.

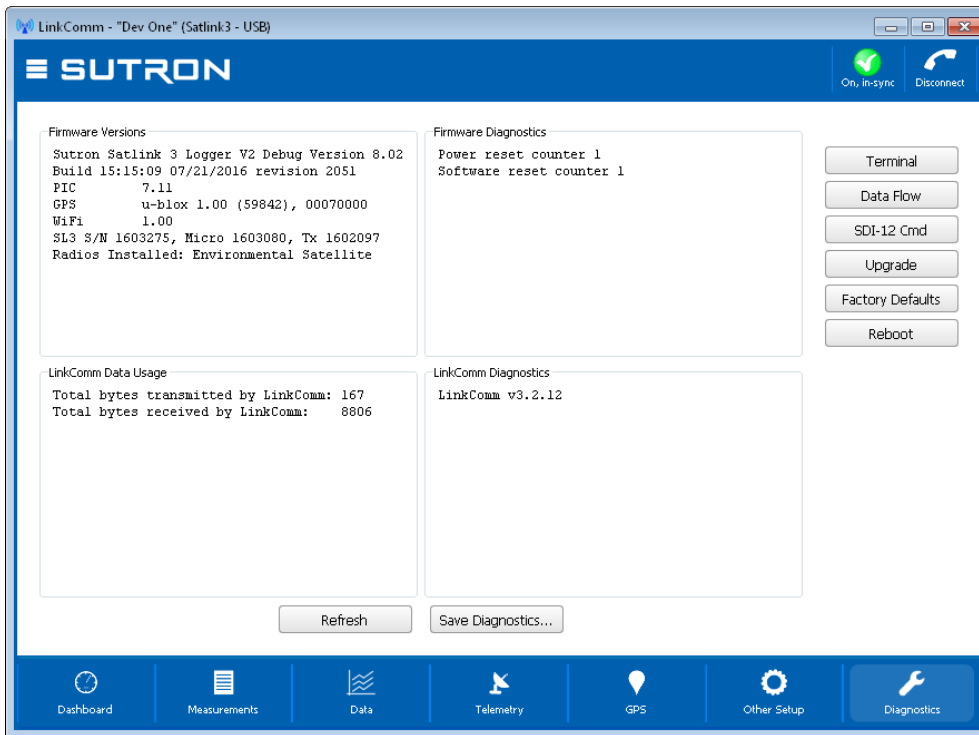

You can also obtain the version of the software using the VER command via command line.

## 7.14 Setting Time

Station time can be viewed via LinkComm on the Dashboard tab. Note that the time shown in the dashboard is a snapshot of the time.

To set the time, use LinkComm's Diagnostics tab and click the Set Clock button.

Use the *Local Time Offset* to convert the time from UTC to a local time zone. The setting is found on the Other Setup tab in LinkComm.

### 7.14.1 Automatic Time Sync

Stations equipped with a modem will automatically their clock to network time. Unless you change the [LOCAL TIME OFFSET](#) setting (as per section [12.7.1](#)), the station will use UTC time.

- ▶ Stations equipped with an Iridium modem will automatically sync their clock to network time.
- ▶ Stations equipped with a cell modem will automatically sync provided they are running firmware version 8.28 or newer. Please see [11.2.3.8 CELL TIME SYNC ENABLE](#).

## 7.15 USB Thumb Drive (Flash Drive) Operation

Several convenient functions are provided via the USB Host port. A USB thumb drive (aka Flash drive) is required to use the port. The drive must be pre-formatted with the FAT32 operating system.

Whenever a correctly prepared USB drive is plugged in, the system will automatically do the following:

- ▶ Download data since last download to the USB drive
- ▶ Save station setup (and Python script) to the USB drive
- ▶ Save station diagnostics to the USB drive

Additionally, if the appropriate files have been previously loaded on the USB drive, the following will take place:

- ▶ Upgrade firmware
- ▶ Change station setup
- ▶ Change station Python script file
- ▶ Execute command line file

USB operation status is indicated via the front panel LEDs:

- ▶ When a USB drive is plugged into the station, the amber LED will start blinking rapidly while the drive is in use.
- ▶ Once the operation completes, if everything went well, the green LED turns on solid. If there was a problem, the red LED turns on solid.
- ▶ The LED remains on until the drive is removed.
- ▶ The LED pattern was improved in version 8.24.

Notes about USB operation:

- ▶ Do not leave the thumb drive inserted after the operations complete. Leaving it inserted will result in increased power draw and it will provide no benefit.
- ▶ Do not remove the drive while the operation is in progress!
- ▶ The Wi-Fi button is disabled during USB drive operations.

### 7.15.1 Download data to USB Thumb Drive

To download data to a USB drive, simply insert a USB drive (already formatted FAT32) into the front of the unit. Data since the last download will be automatically downloaded to the drive.

The following folder structure is used on the USB Drive (and will be created if not present):

`\Sutron\XLink\`

where **<station>** is the name of the station and **<date>** is the current date in `yyyymmdd` format (e.g.: "20160204")

Output files are always placed under the full path and given a unique name by appending `_01`, `_02`, `_03`, ..., `_99` to the name as necessary.

#### 7.15.1.1 *Regarding Events*

- ▶ By default, plugging in a USB drive will result in only measurement data being downloaded to the log file. Events are excluded from the log file.
- ▶ If the following file is located on the USB drive, then the system will download both measurement and event data:
  - ▶ **\Sutron\XLink\IncludeEvents.txt**
  - ▶ The file content does not matter. If the file is on the drive, in the specified path, the system will download both measurements and events.
  - ▶ The rules above apply to software 8.24 and newer. Older versions will always download both measurements and events to the log file.

#### 7.15.1.2 *Regarding Headers*

- ▶ Logs are downloaded without a header to ease import of log files into other systems.
- ▶ If the following file is located on the USB drive, then the system will include a header in the downloaded log file:
  - ▶ **\Sutron\XLink\IncludeHeader.txt**
  - ▶ The file content does not matter. If the file is on the drive, in the specified path, the system will download both measurements and events.
  - ▶ The rules above apply to software 8.33 and newer. Older versions will always download both measurements and events to the log file.

#### 7.15.1.3 *Regarding SD Cards*

By default, the log download is done from the station's on-board flash memory to the USB drive.

If the station is equipped with an SD card, the log is automatically backed up to the SD card. Because the SD card may provide more storage space than the on-board flash memory, you may choose to copy the log data from the SD card instead.

The setting *USB Drive Gets Log From* may be changed to *SD Card* to have the log data copied from the SD card to the USB drive.

#### 7.15.1.4 *Files Created on the USB Drive*

The files created when the USB drive is plugged in include:

- ▶ log data (ex: "TestStation\_log\_20161231\_02.csv")
- ▶ diagnostic data (ex: "TestStation\_diag\_20161231.txt")
- ▶ setup files (ex: "TestStation\_setup\_20161231.txt")
- ▶ results from setup import (ex: "TestStation\_setup\_results\_20161231.txt")
- ▶ output from script execution (ex: "TestStation\_script\_results\_20161231.txt")

## 7.15.2 Upload Setup via USB Thumb Drive

It is possible to change station setup by plugging in a USB drive that contains the new setup.

LinkComm's setup files can be exported by LinkComm and then copied to a USB drive such that they will automatically be installed when the USB drive is plugged into the USB Host slot in the station. The setup is specific to the station.

There are two options:

- ▶ Create a setup file for one specific station
- ▶ Create a setup file for all stations

### 7.15.2.1 Setup for One Specific Station

This setup is specific to one station. For every station you wish to setup, a different setup file must be created and placed on the drive.

To update station setup with a USB drive:

- ▶ Use LinkComm to create a setup.
- ▶ Use LinkComm's export setup menu option to create a setup file.
- ▶ The setup file must be named "**StationName\_setup.txt**", where "StationName" is the current name of the station that will have its setup updated. If you do not know the name of the station to update, you will not be able to update it with the USB thumb drive.
- ▶ Copy the setup file to a USB drive and place in the **\Sutron\XLink\StationName** directory, where StationName is the current name of the station that will have its setup updated.
- ▶ If there is a Python script file associated with the setup, it needs to be named **StationName\_script.py**
- ▶ Plug the USB drive into the station.

After the setup has been processed it will be renamed to prevent it from being processed in the future (ex: "TestStation\_setup\_installed.txt"). This means you cannot use the same setup file to update multiple stations.

Example: to upload a new setup to the station named "TestStation", place the setup file in the following folder of the USB drive:

- ▶ \Sutron\XLink\TestStation\TestStation\_setup.txt

Then plug the thumb drive into the station's USB Host connector. If there was an accompanying Python script, it would need to be in

- ▶ \Sutron\XLink\TestStation\TestStation\_script.py



### 7.15.2.2 Setup for All Stations

This setup may be used to change the setup in any station. A single setup will be written to every station that the USB drive is plugged into. However, certain settings may not be changed with the all stations setup. These settings are

- ▶ Station Name

To update station setup with a USB drive:

- ▶ Use LinkComm to create a setup.
- ▶ Use LinkComm's export setup menu option to create a setup file.
- ▶ The setup file must be named **AllStations\_setup.txt**
- ▶ Copy the setup file to a USB drive and place in in the **\Sutron\XLink** directory.
- ▶ Example file path:
  - \Sutron\XLink\AllStations\_setup.txt
- ▶ If there is a Python script file associated with the setup, it needs to be named **AllStations\_script.py**
- ▶ Plug the USB drive into the station.

### 7.15.3 Update the Firmware via USB Thumb Drive

The firmware may be upgraded with a USB drive. To do so, place the upgrade files (e.g.: XL2EuropaActual\_820r5000.xl2) in the XLink folder of a USB drive. When the USB drive is inserted into the station's USB host port, the station will look for the upgrade file and check to see if the station is running an older version of firmware. The version and revision numbers in the file name are used to make this determination. If the revision on the USB drive is newer, the station will be upgraded.

Example: to upgrade the firmware to 820r5000, place the upgrade file in the following folder of the flash drive and insert the flash drive into the USB Host:

- ▶ \Sutron\XLink\XL2EuropaActual\_820r5000.xl2.

Upgrade files are shipped with LinkComm and may be found in the same directory that LinkComm is installed in.

### 7.15.4 Issuing commands via USB Thumb Drive

A file containing command-line operations may be placed on the thumb drive. Just like setup files, there are two options:

- ▶ Create a command line script file for one specific station
- ▶ Create a command line script file for all stations

#### 7.15.4.1 Command Line File for One Specific Station

This command line file is specific to one station. The file must be named correctly and placed into the correct folder. If the station were called TestStation, the path must be

- ▶ \Sutron\XLink\TestStation\TestStation\_script.txt

#### 7.15.4.2 Command Line Script for All Stations

This command line script will affect every station that the USB drive is plugged into. The file must be named correctly and placed into the correct folder.

- ▶ \Sutron\XLink\AllStations\_script.txt

Any output generated by the command line file will be placed into the output directory that includes the current time.

Here is an example of a file that calibrates measurement M3 to zero, turns on switched power SW2, and sends transmission TX4

```
M3 = 0  
POWER SW2 ON  
TX4 TXNOW
```

This example file downloads all data to the USB drive:

```
LOG ALL
```

Please note that this is NOT for Python scripts. This is for command line operations.

### 7.15.5 Copying files from SD Card to USB Thumb Drive

To copy all files from the SD card to the USB drive, please do the following:

- ▶ Create file on USB drive: \Sutron\XLink \AllStations\_script.txt
- ▶ Put the following line into the file: FILE COPY SD USB
- ▶ Insert USB drive into XLink

If you are just interested in the log files that are on the SD card, LinkComm has an option to automatically transfer them to the USB Drive without the need for a file. See LinkComm's Other Setup tab, External Storage section.

## 7.16 SD Card Operation

The system supports micro SDHC cards with FAT32. Having a card in the system provides the following features:

- ▶ Automatic Log Backup
- ▶ File transmissions (requires Python scripts)
- ▶ File system and storage for Python scripts

*SD Card functionality was added in firmware version 8.33.*

**Please make sure to choose high quality cards that support the appropriate temperature range. Format the card for FAT32.**

#### 7.16.1 Card Handling

Once the SD card is inserted into the system, the system will immediately examine the card. If the card is not compatible, the system will note the error. Please use LinkComm to ensure that the card is working as expected. If LinkComm is not available, please verify correct operation via the LED lights on the front panel.

**The card should be left inserted in the station.** Contrast this with USB drive operations in which the USB drive is inserted into the station, data is immediately copied, and the USB drive is then removed.

You may replace the SD card as a part of routine maintenance. Please make sure to safely remove the card.

#### 7.16.2 Safe Removal

Please use LinkComm to safely remove the SD card. LinkComm's Other Setup tab contains a command to safely eject the SD card. Issue the command first, then remove the SD card.

Failure to safely remove the card may result in SD card data becoming corrupted.

#### 7.16.3 File System Format

The cards must be formatted for the FAT32 file system. Normally, any card that is between 2GB and 32GB in size will be pre-formatted for FAT32. Larger cards may be re-formatted for FAT32 using a computer, but the procedure may require the use of a special program depending on the operating system.

The station also offers a means of formatting the card. Please use the LinkComm terminal and issue the FILE FORMAT SD command. Please see section [17.9.2 FILE COMMANDS](#) for more info about the commands.

#### 7.16.4 Automatic Log Backup

The goal of the automatic log backup is twofold:

- ▶ Redundant sensor data log storage
- ▶ Expanded log storage space

Both features are fully automatic. Simply insert a compatible SD card into the station and leave the card inserted. There are no configuration options.

When a compatible SD card is present, the system will periodically copy new data from the onboard flash log to the SD card. The operation happens once an hour as long as the station is recording and the user is not present (see below).

The result of the automatic log backup is that a file is created on the SD card. That log backup file contains the station's log. The log backup file holds measurement data (no events) in CSV format. This file is normally identical to a log file downloaded from the station using LinkComm.

To access the log backup file, safely remove the SD card from the system, and insert the card into a computer. The FAT32 file system used by the SD card is universally accepted by all major operating systems.

There is a size limit of 1GB for the log backup file. Once the file reach that size, a new file is created. The old file is kept after being renamed with the current time.

Please note that the system will not read the log backup files in order to make transmissions. The onboard flash log must continue to function for the station to operate properly.

#### 7.16.4.1 *Redundant Log*

In the case of a catastrophic failure, if the station is no longer operable, it may be possible to retrieve the logged data from the SD card.

Two backup files are created on the card, providing further redundancy. Under ideal circumstances, both files are exactly the same. However, if one of the files should become corrupt, the other should remain intact.

If you find more than two backup files on your SD card, it means that there has been a failure to backup up the log. The failure could be the result of losing power during the automatic log backup, or it could indicate a problem with the card.

#### 7.16.4.2 *Expanded Log Storage*

Without an SD card, the station has the capacity to hold 1 million sensor readings. By inserting an SD card, that capacity may be increased. The actual capacity is based on the size of the SD card. Here are some estimates:

- ▶ 1GB card stores ~25 million readings
- ▶ 4GB card stores ~100 million readings
- ▶ 32GB card will hold ~800 million readings.

*Please note that these are rough approximations. Each sensor reading is approximately 35 bytes in size. The size depends on the measurement label, the number of right digits, and units.*

If your station logs so much data that the SD card is required, consider replacing SD cards during routine maintenance lest the cards get full. If the card capacity is large enough, you may use a USB drive to copy the log files from the SD card to the USB drive as per [7.15.1.3 REGARDING SD CARDS](#).

#### 7.16.4.3 *Initial Insertion*

When an SD card is inserted for the first time in the system's history, about 30 minutes after user interaction ends, the system will begin the first automatic log backup by copying the onboard log to the SD card. This operation may take a while depending on how much data is in the system's onboard log.

The initial log copy only happens the first time the system receives an SD card. It does not happen every time a new card is inserted.

#### 7.16.4.4 *Backup Paused*

The automatic log backup is paused while the user is interacting with the station in order to facilitate card access and removal. Please make sure to always safely remove the card. This pause happens whenever the station is connected to via Wi-Fi, USB cable, or when a USB drive is inserted.

Additionally, the backup is paused while recording is off.

#### 7.16.4.5 *Backup Log File Location*

The log backup files can be found in the following folders on the SD card:

- ▶ SD/Sutron/XLink/StationName/LogBackup/StationName\_log\_backup\_.csv
- ▶ SD/Sutron/XLink/StationName/LogBackup2/StationName\_log\_backup\_.csv

StationName is the user settable name of the station.

### 7.16.5 File Transmissions

A system equipped with a cell modem is capable of sending files on the SD card to a server via FTP. Python is required to create the files. Please see section [13.2.6 FILE TRANSMISSIONS](#).

## 8 Security

---

XLink provides means of protection against unwanted access. Password protection is at the heart of the security.

Whether accessing the station with a USB cable, an RS-232 cable, via the Wi-Fi hotspot, through a USB thumb drive, over Iridium SBD messages, over cell TCP/IP, or over cell SMS messages, password protection guards access to the station. To access the station, the correct password must be provided.

For remote access over Cell, additional protection is provided over TCP/IP via the use a VPN. To access the station, one first connects to the appropriate VPN.

For Iridium access, additional protection is provided by the Iridium system itself, which blocks access from unauthorized sources. Anyone who seeks to send messages to the station must be on a whitelist provided to Iridium.

Each SMS message sent to the station needs to include the password if the station is to process it. The same holds true for Iridium SBD messages.

The station's Wi-Fi hotspot provides an additional layer of security. It uses WPA2-AES protection, meaning that a Wi-Fi password must be provided to connect to the hotspot. Additionally, the Wi-Fi hotspot is generally off until the site is physically visited and the front panel button on the unit is pressed. Please note that the Wi-Fi hotspot provides access only on site. It does NOT put the station on the internet.

### 8.1 Steps to Take to Protect your Station

Please take the following steps in order to ensure the integrity of your station.

- ▶ Physical access to the station must be restricted.
- ▶ Passwords should be setup and enabled. See below for details.
- ▶ Wi-Fi password protection should be enabled. Wi-Fi enable should be turned off to prevent Wi-Fi from turning on automatically. Please see section [12.1 Wi-Fi](#).

### 8.2 Password Protection

Password protection can be configured to prevent unauthorized access. To setup password protection, please use LinkComm's Change Password menu. Please see section [17 COMMAND LINE INTERFACE](#) for command line access.

XLink provides three tiers of access through a combination of the following settings:

- ▶ Password Protection
- ▶ Setup Password
- ▶ Maintenance Password

- ▶ Read Password

### 8.2.1 Password Protection Setting

A setting called Password Protection needs to be set in order to secure a station. Password Protection may be set to one of the following:

- ▶ DISABLED
  - ▶ In this scenario, full access is allowed without a password. This is the default.
- ▶ SETUP
  - ▶ In this scenario, the system's setup is write-protected. Maintenance and read access are allowed without a password.
  - ▶ Without providing the correct password:
    - ▶ The Station setup cannot be changed. Transmissions may not be started.
    - ▶ Status may be cleared, measurements may be calibrated and forced, failsafe may be reset, unit may be rebooted, clock may be set.
- ▶ MAINTENANCE
  - ▶ System write, and maintenance operations are restricted. Read access is allowed without a password.
  - ▶ Without a password, setup can be read, but not written; status can be checked, but not cleared.
- ▶ FULL
  - ▶ System is fully protected.
  - ▶ No access at all is allowed without a password, except for the following commands: EXIT, HELLO, PASSWORD PROTECTION, VER.

Password Protection must be enabled when connected locally to the station. It may not be enabled nor disabled when connected remotely.

- ▶ If a station is deployed with password protection disabled, the only way to enable protection is locally. Remote access cannot be used to enable protection. Why? To prevent hackers from locking out an unprotected station.
- ▶ If a station is deployed with protection enabled, allowed actions depend on the *Remote Password Change* setting:
  - ▶ If it is On, password protection may not be completely disabled remotely. The *Password Protection* setting may be modified to be *Setup, Maintenance, or Full*, but it may not be *Disabled*.
  - ▶ If It is Off, *Password Protection* may not be modified at all remotely.

### 8.2.2 Passwords

XLink has three different passwords. The access level granted depends on the password provided.

- ▶ Read password
  - ▶ Read access is the most restricted access level. A customer with read access may not make any changes to the system. Read access allows one to view measurement readings, view status, view setup, download the log, and the like.

- ▶ Maintenance password
  - ▶ Entering the maintenance password provides everything that read access does, plus the ability to calibrate sensors, clear status, reboot unit, and other station maintenance related functions.
- ▶ Setup password
  - ▶ Entering the setup password grants complete access to the station.

The default passwords are SUTRON1 for read access, SUTRON2 for maintenance access, and SUTRON3 for full access. Please change ALL THREE passwords when securing your system.

Blank passwords are NOT allowed. All ASCII bytes are allowed except comma, semicolon, equals, and white space. Passwords may be up to 47 bytes long.

#### 8.2.2.1 *Remote Password Change*

A setting called *Remote Password Change* controls whether or not the three passwords may be changed via remote access. The setting's default is On, meaning remote password changes are allowed. It also controls whether or not the *Password Protection* setting may be modified remotely (see previous section).

### 8.2.3 Working with a Password Protected Station

If LinkComm is used to connect to a password protected station, LinkComm will automatically prompt for a password.

When sending a message to a password protected station, the first line of the message must have the login command **LOGIN=XXX**, where XXX is the password.

### 8.2.4 Logging Out

Logging out is accomplished by one of the following:

- ▶ Disconnect with LinkComm
- ▶ Type EXIT in the command line
- ▶ Disconnect the USB cable
- ▶ Power down the unit
- ▶ Connection timeout



## 9 Setup

---

XLink operation is controlled by its setup. The user has the option of changing any part of the setup. The setup is stored in non-volatile memory and will not be affected when the unit loses power.

The LinkComm application is the easiest and fastest way to program your station.

Setup can be changed while the station is collecting data. However, if the station is in the middle of making a measurement when the relevant setup is changed, unexpected effects may occur. Even if unexpected effects occur, the next measurement will be made correctly.

Changes to setup will not affect previously logged data.

Every time setup is changed, it is noted in the log with the entry setup changed. Details of the setup change are not logged.

If a password is enabled, changes to setup cannot be made until the password is entered.

The setup is broken into three sections discussed in detail in the next chapters:

- ▶ measurement setup
- ▶ telemetry setup
- ▶ other setup

Remember that if you ever see at the top of LinkComm, the setup in LinkComm differs from the setup in the station. If the change is deliberate, press the “changed” control to update the station setup. If the change is accidental, use the Main Menu, Get setup From Station function.



You can also change the setup by sending messages to the station via one of the optional modems. As an alternative to LinkComm, you can use any terminal program to access all of the features via the command line interface described in section [17 COMMAND LINE INTERFACE](#).

# 10 Measurement Setup

---

The measurements tab in LinkComm is where the measurement setups are managed.

A measurement is the process of collecting data from a sensor. XLink provides the ability to establish up to 32 measurements, each with its unique settings. Each measurement will occur periodically and provide one sensor reading. How a measurement behaves is governed by its setup. Each of the 32 measurements has its own setup. Changing the setup of one measurement will not affect other measurements (except for *Meta* measurements).

Measurement results may be logged or just used for alarms or by other measurements. The log can hold over 1,000,000 readings (may be expanded to 1,000,000,000 readings). Logged measurement results may be transmitted using installed modems.

Sensor results are internally represented using IEEE 64 double precision floating point values.

The measurement setup is divided into the following sections.

## 10.1 Sensor Setup

### 10.1.1 Active

Making a measurement active is the first step in setup of a measurement. If a measurement is not active, you can still enter a setup; however, the measurement will not be performed.

### 10.1.2 Sensor Template

LinkComm provides templates for many common sensors. The template configures settings for the most important sensor parameters, and includes sensor metadata, e.g., a picture of the sensor, its wiring diagram, manufacturer, model, description, and units. Setting up a sensor using the Sensor template is a great way to avoid setup mistakes.



**Note: Sensor metadata (picture, wiring diagram, etc.), is NOT stored in XLink but only in the station definition in LinkComm.**

The following is an example of a template for an air temperature/relative humidity sensor.

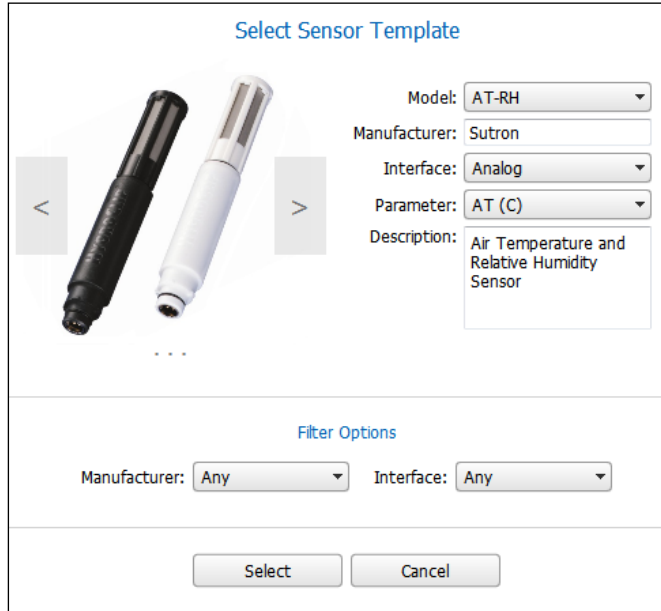

To use the template:

- ▶ Use the right and left arrows on the sides of the sensor picture to scroll between the available sensor templates.
- ▶ Use “Filter Options” to restrict the available sensor templates on the basis of manufacturer or interface.
- ▶ Once you are displaying the desired sensor template, select the related parameters such as interface, parameter before pressing select.

### 10.1.3 Measure Type

This setting tells the station what kind of a measurement to make: SDI-12, analog, battery, etc.

This setting partially determines what physical connection the sensor needs to be wired to.

Measure Type also controls the configuration that follows in the setup. For example, when you select Analog, the configuration section will allow you to enter Analog Type and other related settings.

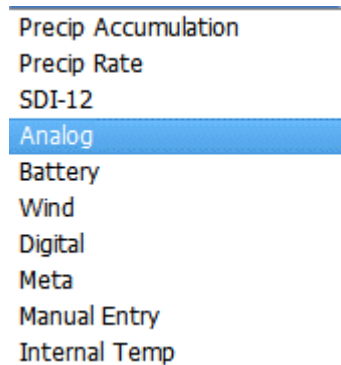

For details on the different measure types, please see section [10.3.1 MEASUREMENT TYPE](#).

#### 10.1.4 Label

User set name given to measurement, up to 11 bytes. This is used to identify and differentiate measurements. This value will be placed in the log each time a measurement is made, so that changing a label will not affect previously logged data. Example labels: AT, Stage, Baro, Precip, Batt.

Please use unique labels for each different measurement. Failure to do so will result in a hard to understand log file. When downloading the log, XLink identifies each logged value with the label.

#### 10.1.5 Model

Model is a text field available to enter the model name or number for a sensor. This is metadata stored in LinkComm but not in the station.

#### 10.1.6 Manufacturer

Manufacturer is a text field available to enter manufacturer information for the sensor. This is metadata stored in LinkComm but not in the station.

#### 10.1.7 Description

Description is a text field available to enter additional information for the sensor. This is metadata stored in LinkComm but not in the station.

#### 10.1.8 Right Digits

The number of digits shown after the decimal place is referred to as the right digits. To make the measurement read 10.12 rather than 10.12345, set the right digits to 2. Note that the result will be rounded to the requested number of digits *before* being logging.

#### 10.1.9 Units

Units can be specified for any measurement and will be stored with the data when it is logged. Use the dropdown list to pick from the built-in list of units. You may also enter the units text directly into the text box. The units text can only be 3 characters long.

#### 10.1.10 Icon

You can select an Icon for the measurement. The icon will show on the dashboard and measurement list. Press “Change” to choose an image in the computer or take a picture. Remember the icon is small and cannot show detailed information.

#### 10.1.11 Picture

A picture of the sensor is shown to the right of the sensor information. LinkComm includes pictures for many common sensors and Measurement Types. Press “Change” to choose an image in the computer or take a picture to use.

#### 10.1.12 Defaults

Press the Defaults control to set all the settings for a specific measurement to default values. Note the default measurement type is SDI-12. Setting defaults will also set the metadata (picture, icon, description etc.) to default values.

## 10.2 Schedule

### 10.2.1 Measurement Interval

Measurement interval is simply the time between scheduled measurements. See Measurement Time.

### 10.2.2 Measurement Time

Measurement interval and time dictate when the measurement will be made. The interval controls how often the measurement is made, and the time controls when the measurement is started.

- ▶ Example 1 (The measurement is logged every 10 minutes at 0 seconds past the minute): time 00:00:00 interval 00:10:00
  - ▶ 00:10:00 data measured and logged
  - ▶ 00:20:00 data measured and logged
  - ▶ 00:30:00 data measured and logged
  - ▶ and every 10 minutes afterwards...
- ▶ Example 2 (The measurement is taken and logged every 5 minutes at 30 seconds past the minute): time 00:00:30 interval 00:05:00
  - ▶ 00:00:30 data measured and logged
  - ▶ 00:05:30 data measured and logged
  - ▶ 00:10:30 data measured and logged

### 10.2.3 Averaging Time, Sampling Interval, Subsamples, and Results

XLink can collect multiple samples and average them in order to produce a single result. Averaging is useful for measuring changing conditions, such as wind and water level. For example, correctly measuring the level of choppy water requires that wave action be canceled. That can be accomplished by averaging over several minutes.

**Setting the *Averaging Time* to 00:00:00 (zero) disables averaging -- one sample is to be collected.** This is the default setup. If *Averaging Time* is zero, *Sampling Interval* and *Subsamples* will not be shown in the setup.

When averaging is enabled, several samples are taken and averaged into a final result. Each sample may also be composed of several subsamples.

- ▶ *Averaging Time* determines **how long** to collect samples for.
- ▶ *Sampling Interval* dictates **how often** to collect each sample.
- ▶ *Subsamples* tell how many sensor readings to include in each sample. Do not use *Subsamples* unless you need two levels of averaging.
- ▶ *Result* lets you specify what statistical value to log: average, min, max, running average, running min or running max.

The simplest averaging requires only the use of *Averaging Time*.

#### 10.2.3.1 Example: Average Temperature Over an Hour

If you want to know the average temperature for an hour, you would set up the *Averaging Time* to one hour. *Sampling Interval* or *Subsamples* would not need to be changed. The station will collect sensor data all throughout the hour as fast as possible.

However, if the power consumption for measuring the sensor continuously for an hour were unacceptable, you would use the *Sampling Interval*.

To take one sample every minute, the *Sampling Interval* should be set to one minute. That way, 60 samples will be taken every hour, with approximately a one-minute break between each sample.

If the sensor being used was noisy and needed filtering, several *Subsamples* could be collected and averaged into one sample.

In the setup for temperature above, if the number of *Subsamples* were set to five, five readings would be collected at the start of every minute and averaged. That result would be used as a sample. Once an hour, 60 samples would be averaged into a final result.

Data collection starts at *Measurement Time + Measurement Interval – Averaging Time + Sampling Interval*, and the last sample is taken at *Measurement Time + Measurement Interval*.

In the example below, temperature is measured every 15 minutes and averaged for an hour:

- ▶ Measurement Time 00:00:00
- ▶ Measurement Interval 01:00:00
- ▶ Averaging Time 01:00:00
- ▶ *Sampling Interval* 900 (900 seconds is 15 minutes)
- ▶ Data Collection
  - ▶ 00:15:00 first sample collected
  - ▶ 00:30:00 next sample collected

- ▶ 00:45:00 next sample collected
- ▶ 01:00:00 last sample collected
- ▶ 01:00:00 all four samples are averaged and the result is logged with the 01:00:00 timestamp

The *Results* field will be shown only if averaging is enabled. If it is enabled, you can select **average**, **minimum**, **maximum**, **running average**, **running minimum**, **running maximum** to be the logged result value. The difference between average and running average is as follows:

**Average** – Starts a new average each measurement interval. Computes average only at the end of all the samples. Tracks min/max of each sample as it is measured.

**Running Average** – Running averages continue across measurement intervals. The running average is recomputed with each sample. It tracks min/max of the running average (not individual samples) throughout the interval. As a result, the running minimum and running maximum will be less extreme than the simple minimum and maximum.

If you want to transmit average, minimum, and maximum results, you need to set up three identical measurements except for the *Results* field: one measurement would choose results average, one minimum and one maximum. Note: even though you setup 3 separate measurements, as long as the schedule is identical, the system will only be reading the sensor once.

#### 10.2.3.2 *More on the Running Average*

A Running Average is used when readings need to be averaged over a time period that is longer than the logging interval.

For example, if you would like to produce an hourly average every 15 minutes, you would use a Running Average. In that case, the Averaging Time should be 01:00:00 and the Measurement Interval should be 00:15:00.

For Running Average, Averaging Time may be longer than Measurement Interval. In fact, unless it is longer, there is no point in using a Running Average as the result will be the same as a Simple Average.

- ▶ The Measurement Interval and Measurement Time will determine how often a reading is produced.
- ▶ Averaging Time dictates the time span over which samples will be averaged.
- ▶ Sampling Interval tells the system how often to sample the sensor.

If you are interested in logging a five-minute average every minute, set Averaging Time to five minutes, Measurement Time to one minute and Sampling Interval to 60 seconds. Here is the timeline of the data produced:

- ▶ 12:01 Sample sensor (reading = 1.0). There are not enough samples to produce an average. System will still compute and log a result producing a value of 1.0;
- ▶ 12:02 Sample sensor (reading = 2.0). There are not enough samples to produce an average. System will still compute and log a result producing a value of 1.5;

- ▶ 12:03 Sample sensor (reading = 3.0). There are not enough samples to produce an average. System will still compute and log a result producing a value of 2.0;
- ▶ 12:04 Sample sensor (reading = 4.0). There are not enough samples to produce an average. System will still compute and log a result producing a value of 2.5;
- ▶ 12:05 Sample sensor (reading = 5.0). Compute and log 5-minute average. Result = 3.0, computed as  $(1.0+2.0+3.0+4.0+5.0)/5$ ;
- ▶ 12:06 Sample sensor (reading = 6.0). Compute and log 5-minute average. Result = 4.0, computed as  $(2.0+3.0+4.0+5.0+6.0)/5$ ;
- ▶ 12:07 Sample sensor (reading = 7.0). Compute and log 5-minute average. Result = 5.0, computed as  $(3.0+4.0+5.0+6.0+7.0)/5$ ;

Compare this to a simple average. A simple average over five minutes would produce a reading every five minutes. It would be setup with Measurement Interval of five minutes, an Averaging Time of five minutes, and a Sampling Interval of 60 seconds.

- ▶ 12:01 Sample sensor (reading = 1.0). No reading is logged.
- ▶ 12:02 Sample sensor (reading = 2.0). No reading is logged.
- ▶ 12:03 Sample sensor (reading = 3.0). No reading is logged.
- ▶ 12:04 Sample sensor (reading = 4.0). No reading is logged.
- ▶ 12:05 Sample sensor (reading = 5.0). Compute and log 5-minute average. Result = 3.0, computed as  $(1.0+2.0+3.0+4.0+5.0)/5$ ;
- ▶ 12:06 Sample sensor (reading = 6.0). No reading is logged.
- ▶ 12:07 Sample sensor (reading = 7.0). No reading is logged.

A Result of Running Min and Running Max produce results which are the minimum and maximum of the Running Average during the interval. Just like the simple minimum and maximum, running minimum and maximum values are logged with the time stamp of when the minimum and maximum occurred rather than when the measurement was scheduled.

The system holds up to 180 samples for the Running Average. How many samples are to be used is computed by dividing the Averaging Time with the Sampling Interval. If the setup is such that more than 180 samples are required, the system will show a setup error:

- ▶ Setup Errors: M1 Too many samples setup for running average
- Additionally, every time a measurement is completed without all the samples, the system will log a "Missing samples" error.

### 10.2.3.3 Logging and Transmitting Minimum and Maximum

The time for the average will be computed based on the measurement time and interval, as described previously. However, the time stamp for the minimum and maximum will be the actual time when the minimum or maximum occurred. For example, you may see the following in the log for an hourly average with samples every minute where the data is not in time sequence:

- ▶ 4/14/2016 16:00:00 AVG 30.335 G
- ▶ 4/14/2016 15:24:00 MX 31.248 G
- ▶ 4/14/2016 15:15:00 MN 25.661 G
- ▶ 4/14/2016 17:00:00 AVG 30.225 G



- ▶ 4/14/2016 16:12:00 MX 32.060 G
- ▶ 4/14/2016 16:39:00 MN 28.454 G

Explanation of the logged data above: At 16:00 the hourly measurement that started at 15:00 is complete. The average gets timestamped with 16:00. However, the actual maximum value of 31.248 happened at 15:24 and the minimum value of 25.661 happened at 15:15. Likewise, at 17:00, the measurement that started at 16:00 is complete. The maximum happened at 16:12 and the minimum at 16:39.

When it comes time to transmitting minimum and maximum results, a unique timestamp will be included with each value transmitted. An example below illustrates the formatting:

```
:ATMIN 91 #60 22.47 :ATMIN 101 #60 22.50 :ATMIN 191 #60 22.53  
:ATMAX 71 #60 22.52 :ATMAX 136 #60 22.54 :ATMAX 216 #60 22.58  
:ATAVG 41 #60 22.50 22.52 22.56
```

:ATMIN 91 #60 22.47 means that a minimum of 22.47 occurred 91 minutes ago.  
:ATMIN 101 #60 22.50 means that a minimum of 22.50 occurred 101 minutes ago.  
Contrast that format with :ATAVG which provides four readings on the same line, most recent one 41 minutes ago, and subsequent readings each an hour later.

## 10.3 Configuration Settings

### 10.3.1 Measurement Type

The *Measurement Type* setting (in the Sensor section) will determine what kind of measurement is made. Each of the different types will unlock other settings. For example, choosing *Analog* as the *Measurement Type* will unlock the *Analog Type* setting.

The available *Measurement Type* options are

- ▶ Precip Accumulation
- ▶ Precip Rate
- ▶ SDI-12
- ▶ Analog
- ▶ Battery Voltage
- ▶ Wind
- ▶ Digital
- ▶ Meta
- ▶ Manual Entry
- ▶ Internal Temp
- ▶ Modbus

Below are listed all the *Measurement Types* available.

### 10.3.2 Measure Type: Precip Accumulation and Precip Rate

Connection: Terminal #12 TB/DIN#2 and Terminal #11 Ground

Precip Accumulation and Precip Rate are designed to measure the pulses from a tipping bucket type rain gauge.

Precipitation accumulation is used to tally the total amount of precipitation since the station has powered up. Count must be set to zero by the user when the station is installed. Counts persist between power-ups.

Precipitation rate, unlike precipitation accumulation, measures the precipitation that has occurred since the last measurement. So, if the measurement interval is 15 minutes, this measurement will report the rainfall in the last 15 minutes only.

Multiple measurements can be set up with the same input. For example, if you wanted to know the daily rainfall and the rainfall during the last hour, set up two measurements: one a *Precip Rate* with an interval of one hour, and another as *Precip Rate* with an interval of one day.

Usually, a slope is applied to convert the counts from the tipping bucket into inches of rain. For example, setting the *Slope* to 0.01 means that each tip of the bucket is 0.01".

Precip readings are de-bounced for 4ms.

#### 10.3.2.1 Notes on Precip Rate

Precipitation rate is computed as the current count minus the count at the last scheduled measurement.

- ▶ The first scheduled reading of precipitation rate is invalid, as it takes two readings before the difference can be computed.
- ▶ When the system is not running, it is not able to make sensible Precip Rate readings.
- ▶ Forced (live) precipitation rate readings are unreliable. The rate will be computed over the currently elapsed time and extrapolated over the rest of the interval.

#### 10.3.2.2 Precip Accumulation Reset

XLink may be setup to automatically reset precip accumulation.

▶ Precip Accumulation Reset may only be performed on a tipping bucket connected to TB/DIG IN 2. When the station is setup for Precip Accumulation, it may also be setup to automatically reset the accumulation at a specific time.

The Accumulation Reset options are

- ▶ Off (default)
- ▶ Daily
- ▶ Monthly
- ▶ Yearly

When Accumulation Reset is active, additional settings are used to tell when to reset accumulation:



- ▶ Accu Reset Month (default is 0)
- ▶ Accu Reset Day (default is 0)
- ▶ Accu Reset Hour (default is 0)

By default, when the station is setup for a Daily reset, it will reset accumulation at midnight of the next day. Monthly resets, by default, happen on midnight of the first day of the month. Yearly resets, by default, happen on midnight Jan 1st.

If one wanted to reset accumulation at 11AM on July 2nd every year, one would set the Hour to 11, Day to 2, Month to 7, and Accumulation Reset to Yearly.

If one wanted to reset accumulation at noon every day, one would set the Hour to 12 and Accumulation Reset to Daily.

Whenever accumulation is reset, additional data is written to the log. The example below has measurement M3 setup for Precip Accumulation with Accumulation Reset set to Daily. The measurement is scheduled every minute. The label is PRECIP\_DAIL.

- ▶ 02/28/2019,23:57:00,PRECIP\_DAIL,1.23,in,G
- ▶ 02/28/2019,23:58:00,PRECIP\_DAIL,1.24,in,G
- ▶ 02/28/2019,23:59:00,PRECIP\_DAIL,1.24,in,G
- ▶ 02/28/2019,23:59:59,M3 Daily,1.24,in,G
- ▶ 03/01/2019,00:00:00,Accumulation Reset,3,,G
- ▶ 03/01/2019,00:00:00,PRECIP\_DAIL,1.24,in,G
- ▶ 03/01/2019,00:01:00,PRECIP\_DAIL,0.00,in,G
- ▶ 03/01/2019,00:02:00,PRECIP\_DAIL,0.01,in,G

Please note how the PRECIP\_DAIL is logged at midnight on 03/01/2019 with the PREVIOUS day's accumulation.

Note how the system automatically creates a M3 Daily log entry at 23:59:59 on 02/28/2019. The M3 Daily log entry is meant to help with historic records by providing the daily accumulation with a timestamp of the day that it happened on. The M3 Daily entry does NOT get transmitted.

Note also the Accumulation Reset log event indicating that M3 counts were reset.

When accumulation is reset, the appropriate Daily, Monthly and/or Yearly log entries are created. Those log entries are created with a pre-date of one second less than the time of accumulation reset. By default, that means the Yearly log entry will have a timestamp of 12/31 23:59:59. Monthly timestamps are on the last day of the month at 23:59:59. Daily timestamps are at 23:59:59.

When Precip Accumulation is reset, the counts are set to zero and the measurement Offset is also set to zero. That means that the first reading after the reset will show an accumulation of zero (unless precipitation happens between the reset and the first reading, in which case it is counted).

#### 10.3.2.3 *Power loss and Precip Accumulation*

Precip accumulation information is stored in persistent memory. It is not lost when power is removed.

After it is powered on, and after the first Precip Accumulation reading is made, an accumulation reset may occur. The reset will be made if an accumulation reset interval has been missed.

For example, take a station setup for Daily resets. Say the station lost power on 22:00:00 Feb 14th, and regained power on 07:00:00 Feb 15th. Since it missed the reset at 00:00:00 Feb 15th, it will reset accumulation right away.

Another example: a station is setup for Monthly resets. Just as above, it loses power on the 14th, and regains it on the 15th. It will not perform a reset.

If it does choose to reset accumulation, the system will log the current counts first along with a log entry indicating that accumulation was reset.

#### 10.3.2.4 *Setting up Multiple Precip Accumulation Measurements*

A station may be setup to tally Daily, Monthly, and Yearly accumulation on the same tipping bucket. To do so, setup three measurements. Each should be of the Precip Accumulation type, and their Accumulation Reset settings may be Off, Daily, Monthly, or Yearly. The measurement schedule is up to the customer. For example, Daily readings can be made every minute and Monthly readings can be made only once a day. Note that the system cannot log less frequently than once a day.

Please note that if multiple Precip Accumulation (or Precip Accumulation and Digital Counter 2) measurements are setup, calibrating one measurement will clear out counts for all the measurements. That does NOT mean that the measurements cannot be calibrated individually. It does mean that each of the measurements must be calibrated.

For example, if installing a station that collects Daily, Monthly, and Yearly accumulation, and the current yearly accumulation is 12 inches, the current monthly is 2 inches, and current daily is 0.1 inches, simply calibrate the Yearly to 12, Monthly to 2, and Daily to 0.1.

#### 10.3.2.5 *Note on Precip Accumulation and Other Counts*

This section talks about measuring counts. The system may be setup for precip accumulation, precip rate, or digital counter type measurements. All of these measurement types fall into the 'counts' category. A tipping bucket is commonly connected to count type inputs. There are two physical inputs for counts:

- ▶ WS/DIG IN 1
- ▶ TB/DIG IN 2

The system keeps a tally for each of the two counter inputs. The tally is stored in persistent memory, meaning that counts are not lost when power is removed. To reset the counts, calibrate one of the counter measurements to zero.

The system keeps counting even when Recording is OFF, as long as there are active measurements set up that use the counter inputs.

When a count measurement is calibrated, the count tally for that input is set to zero, and the measurement's Offset is to the calibrated value. For example, setting Precip Accumulation reading to 10.2 will clear the tally for TB/DIG IN 2, and set the measurement's Offset to 10.2.

### 10.3.3 Measure Type: SDI-12

SDI-12 sensors traditionally connect over the SDI-12 bus:

- ▶ SDI-12 Port: Terminals #14 Ground, #15 +12V, and #16 DATA.
- ▶ Please note: The SDI-12 port is independent with isolated +12V power and Data connections. Power is limited to 500mA. Sensors that use more than 500mA (such as bubblers) must connect to an independent power supply.

SDI-12 is a standardized three wire digital interface. Many manufacturers provide SDI-12 sensors that measure different environmental effects. SDI-12 sensors provide digital data which improves their reliability and accuracy in terms of logger sensor communications.

For details on SDI-12, please see section [18 MORE ABOUT SDI-12](#).

Some sensors allow for the SDI-12 protocol to be used over the RS-485 bus in order to support extended cable lengths. These sensors use the following connection:

- ▶ RS485 Port: Terminals #5 RS485-A and #6 RS485-B

#### 10.3.3.1 *SDI-12 Port*

SDI-12 sensors can be assigned to Port1, Port2 or RS485. Remember that multiple sensors can be connected to either bus as long as each sensor has a unique address. Use RS-485 when you need long cable runs to the sensor and the sensor supports SDI-12 over RS-485.

#### 10.3.3.2 *SDI-12 Address*

Multiple sensors can be connected to the same SDI-12 bus. However, each sensor needs a unique address. The address is a single ASCII character. Most sensors default with the address 0. If you are connecting several sensors, connect them one at a time. As each sensor is connected, issue the 0Ax! command, changing the sensor's address from 0 to x, where x is a unique number or letter of your choice.

#### 10.3.3.3 *SDI-12 Command*

Select the desired SDI-12 command from the drop-down list or enter a unique command into the text box. The drop-down list includes M!, M1!, MC!, C!, CC!, M2!. Consult the operating manual for the sensor to know what command to use. The software automatically adds the address when issuing the command. The software also automatically issues the commands to retrieve the data after the measurement command is issued.

#### 10.3.3.4 *SDI-12 Param*

Most SDI-12 sensors will respond to the measure command with multiple data values. The *SDI-12 Param* designates which of these data values the user is interested in.

Setting the parameter to 1 tells the station to use the first value returned from the sensor; setting parameter to 3 tells the station to use the third value returned from the sensor.

If you want to record (and transmit) more than one parameter from a single SDI-12 sensor, a different measurement needs to be set up for each parameter. These measurements should have identical setups, except for the *SDI-12 Param* setting. Be sure to keep the measurement time and interval the same for these measurements and the station will make a single measurement to provide the data for both. If you vary the time and interval, the station will end up taking multiple sensor measurements even though one would have sufficed (thus slowing down the system and using more power).

In the case of devices which require multiple commands to be issued (e.g. 0M1! retrieves pressure, 0M2! retrieves temperature) multiple measurements need to be set up. It does not matter if these measurements are scheduled for the same time, as the station will have to issue multiple commands to the sensors.

When multiple measurements of type SDI-12 are scheduled to go at the same time, the station orders the measurement commands so that concurrent measurements are commanded first. Non-concurrent measurements occur while waiting for concurrent results. Also, the station is able to recognize when two different measurement schedules rely on data from a single measurement command (e.g., measurement 1 commands 0M! and expects parameter 1 while measurement 2 commands the same and expects parameter 2, both scheduled at the same time). In such cases, the station outputs the measurement command only once.

#### 10.3.3.5 Warmup

If this number is not zero, then the Switched Power line (terminal #8, SWD+12V) and VREF (terminals #25 and #21) will be turned on for warmup seconds prior to talking to the SDI-12 sensor. The line will be kept on until the measurement completes.

You may use SWD#1 12V instead of SDI-12 Power to supply power to the SDI-12 sensor as long as the sensor does not require to be powered on all the time. Some sensors (such as the Sutron SDR) need to be powered on all the time and will not work correctly if powered from the Switched Power line.

**If you power the sensor via Switched Power, you must setup the Warmup to at least one second!**

Why use Switched Power instead of SDI-12 Power? To reduce power consumption of the SDI-12 sensor. SDI-12 Power is turned on all the time, while Switched Power is only turned on during the measurement if Warmup is not zero.

Please note that using LinkComm's Send SDI-12 Command window will NOT turn on Switched Power. However, doing a Live/Forced measurement will.

#### 10.3.3.6 SDI-12 Command Utility

The SDI-12 command utility dialog is used to send SDI-12 commands to sensors. It can also be used to quickly find what sensors are connected to the SDI-12 bus.

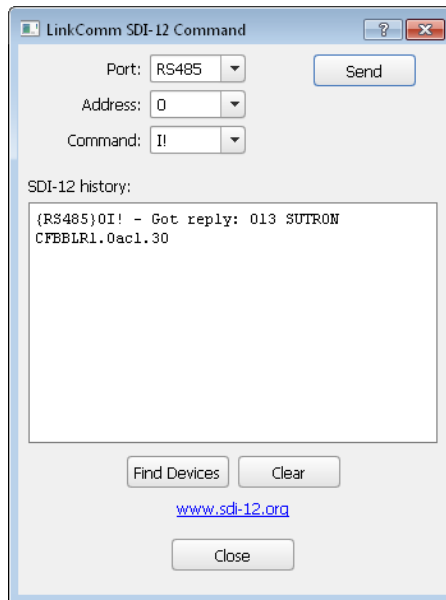

To send a command to an SDI-12 device, enter the **Address** and **Command** fields, and then press the **Send** button. Be sure to select the proper port. The results of the command are shown in the SDI-12 history window.

To have the station look for any and all sensors on the SDI-12 bus, press the **Find Devices** button. Information regarding what sensors are found is displayed in the SDI-12 history window.

Press the **Clear** button to clear the SDI-12 history window.

### 10.3.4 Measure Type: Analog

Analog measurements involve reading a voltage or current provided by a sensor. Analog sensors come with instructions that provide information on how to translate the output voltage into desired units. Translating the analog sensor output into environmental units can be done via slope and offset for simple sensors, and via equations for non-linear sensors.

Analog measurements are available on select models.

#### 10.3.4.1 Analog Type

This setting directs the input channel to which the sensor should be connected and the type of analog measurement to make. These options are available

- ▶ 0-5V A
- ▶ 0-5V B
- ▶ Diff C
- ▶ Diff D
- ▶ 4-20 mA

#### 10.3.4.2 0-5V A and 0-5V B

- ▶ **Connection A: Terminal #32 analog ground and terminal #31 0-5V signal**
- ▶ **Connection B: Terminal #30 analog ground and terminal #29 0-5V signal**

Inputs 0-5V A and 0-5V B are designed to be general purpose 0-5 Volt DC input. While sometimes referred to as a single-ended input, it is designed to measure voltage with respect to analog signal ground. These inputs have a high impedance (>2 Meg Ohms) and will not load down or draw significant current. The input range is 0V to 5V. Negative voltages with respect to SIGNAL GROUND may NOT be measured on these inputs.

To connect a sensor:

- ▶ The voltage **output** by the sensor should be connected to either A or B.
- ▶ The **analog ground** from the sensor needs to be connected to Signal ground.
- ▶ The sensor will likely require **power** – connect that to VREF if 2.5V is appropriate or to +SWD#1 POWER which is 12V (or whatever power the station is supplied with). Make sure to set up the warmup (the amount of time to power the sensor before reading its output) as required by the sensor.
- ▶ If the sensor has a power ground, connect that to Signal Ground.

#### 10.3.4.3 Diff C, Diff D

- ▶ Connection: Diff C (Terminals #28 and #27)
- ▶ Connection: Diff D (Terminals #24 and #23)
  - ▶ Optional connection to VREF (#25 or #21) and Signal ground (#26 and #22) as needed

Measurements Diff C, and Diff D are designed to operate with a special type of analog output found on many sensors that use a bridge configuration or any sensor that outputs a very small voltage. This input type has a + and - input that connects to the sensor output.

Typically, a bridge sensor will be powered on VREF (sometimes referred to as excitation), have a signal + and signal –, and provide a wire for the analog ground. NOTE: If after wiring the sensor, it displays a negative reading, you may reverse the + and - leads coming from the sensor.

Reading Negative Output Voltages on Differential Inputs:

In limited cases, sensors with negative outputs may be used on the differential inputs with the following limitations:

- ▶ The negative line from the sensor must not connect to the digital ground of the sensor with the sensor making a ground connection to the ground (including antenna ground) of the station. (i.e. the sensor outputs must be able to be floated with respect the grounding of the sensor itself)



- ▶ The negative voltage (or positive voltage) must remain within the range of the differential input range selected.
- ▶ The common mode input range of the differential inputs must not be exceeded (see below).

While the differential inputs are capable of reading negative voltages, it is important to keep the voltages with respect to ground within in the common mode input range of 0.5 to 3.7 volts. In the case of a bridge sensor, by using the Vref and signal ground to establish the voltage on the network, you are assured of having a positive voltage with respect to signal ground. In the case of the bridge, you simply need to remain within the voltage range selected (see 6.1.4.12 below) and simultaneously remaining in the common mode range of the inputs or 0.5 volts to 3.7 volts.

#### 10.3.4.4 *Input Range*

This setting is relevant only to analog differential measurements. Remember that the system must read a voltage that falls into the common mode range mentioned in the above note. Voltages that are negative with respect to the analog ground terminal may not be measured. The following options are available:

- ▶ -39 to +39mV
  - ▶ -312 to +312mV
  - ▶ -2.5 to +2.5V
  - ▶ -39 to +39mV with Bias
  - ▶ -312 to +312mV with Bias
- ▶ Note that the ranges for absolute measurements are nominal. Guaranteed analog input range over temperature is 0-4.98 V,  $\pm 2.49$  V,  $\pm 311$  mV, and  $\pm 38.9$  mV.

Choose the option that is close to and greater than the input range of the sensor that is being connected.

For example, if a sensor provides a reading from 0 to 100mV, choose the 312mV option. If you were to choose the 39mV option, when the sensor provided a reading greater than 39mV, the unit would indicate a sensor failure.

Use the range “with Bias” if the sensor is not powered by the station. Pyranometer and thermocouple type sensors should use bias.

#### 10.3.4.5 *4-20 mA*

Connection: 4-20ma (Terminal #20)

This input is designed to function with sensors that have a 4 to 20ma current loop interface. This type of interface is superior to voltage outputs when the cables to the sensors must travel a long distance or when the equipment is located in electrically noisy environments. The station will measure the current flowing when connected to the 4-20ma Input. Typical 4-20ma sensors will give a 4 to 20ma current for a 0 and 100% FS. Readings that are greater than 21mA will be considered a fault. The current required for the sensor is provided by the 2 wire loop and does not typically require additional connections.

NOTE: The station does not provide a dedicated power supply for 4-20ma sensors. The sensor shall have its own supply or run off the 12 volt supply of the station. While the internal 4-20 measurement is made

using an accurate 100 Ohm resistor, the overall loop resistance is 200 ohms due to an additional 100 Ohms series protection resistor. This means that a sensor at a full 20 ma current output, approximately 4 volts should be allotted for overhead voltage. This is typically not an issue when an external voltage source is provided to operate the sensor that may be in the 18 to 24-volt range. However, if a 12.5-volt battery is used to source the voltage for the sensor in the current loop, then only 8.5 volts will be supplied to the sensor at max sensor current output. Therefore if a full 12 volts is necessary for the sensor, an external loop supply will be necessary or alternately the sensor may be wired to a single-ended voltage input with the use of an external 100 Ohm accurate and stable resistor also attached to the voltage input port.

#### 10.3.4.6 Warmup

Analog sensors are powered by the station via one of several outputs:

- ▶ VREF (reference voltage) which provides 2.5V, terminals #25 and #21.
- ▶ Switched Power which provides whatever voltage is powering the station, presumably 12V, on terminal #8.

Normally, these outputs are off. Prior to making an analog measurement, the system will turn on these outputs. After that, the system waits *Warmup* amount of time (which is expressed in seconds) before measuring the output of the sensors. This *Warmup* time gives the sensors a chance to power up and prepare their outputs.

If *Warmup* is set to zero, the system will not wait at all prior to measuring. The value *Warmup* should be set to depends on the analog sensor being measured.



**Warmup is also used for *Digital and SDI-12* type sensors. If a such a sensor (or a wind sensor that uses digital or SDI-12 inputs) is set up with a warmup, then VREF and Switched Power (SWD#1) will both be turned on. If warmup is set to zero, those output lines will not be turned on. This is different for *Analog* measurements which turn on the lines regardless whether warmup is zero.**

#### 10.3.5 Measure Type: Battery

This type measures the voltage of the battery connection to the station. This measurement is a useful diagnostic for tracking the performance of the battery and any solar panel or other charging equipment.

#### 10.3.6 Measure Type: Wind

The Wind measure type makes it possible to do vector averages of data from wind speed and direction sensors. The normal average function does not typically work for wind sensors because of the circular nature of the direction measurement. The vector averages take into account the 0 to 360 degree crossover to produce accurate average.

Follow these steps to setup for Wind averages:

- ▶ Step 1) Setup a measurement to measure the wind speed (see section [5.19 CONNECTING PROP/VANE OR ANEMOMETER/VANE WIND SENSORS](#))
  - ▶ Set measurement interval for how often you want the speed measured
  - ▶ Use slope/offset/equation to properly scale the speed to the desired units.

- ▶ Disable logging for the data (log interval = 24:00:00)
- ▶ Disable transmission of the data (TX Data Content = Exclude)
  
- ▶ Step 2) Setup a measurement to measure the wind direction (see section [5.19 CONNECTING PROP/VANE OR ANEMOMETER/VANE WIND SENSORS](#))
  - ▶ Set measurement interval for how often you want the direction measured
  - ▶ Use slope/offset/equation to properly scale the direction to degrees.
  - ▶ Disable logging for the data (log interval = 24:00:00)
  - ▶ Disable transmission of the data (TX Data Content = Exclude)
  
- ▶ Step 3) Setup measurement(s) to do the wind calculations with the desired results
  - ▶ Select Wind measure type
  - ▶ Configure the speed and direction index to the measurements setup in steps 1 and 2
  - ▶ Pick the desired result type.
  - ▶ Set the schedule interval and averaging time for the duration of the averaging.
  - ▶ Set the sampling interval equal to the measurement interval of the speed and direction sensors.
- ▶ Repeat Step 3 for additional result types.

#### 10.3.6.1 More on the Wind Measure Type

When you select the Wind Measure type, the configuration section will allow you specify where to get the speed and direction data and what kind of result to log. The Wind measure type requires you to setup separately the speed and direction measurements and provide the index in the configuration. Normally, you will want to setup these measurements before setting up the Wind type. Speed index is the measurement setup separately to get the speed. Direction index is the measurement setup separately to get the direction. Make sure each input is configured to provide the data in the proper units (mph, mps ... for speed and degrees for direction). You will want to schedule these measurements to occur at the interval you want for your vector processing (e.g. 00:00:10 or 00:01:00). You will also want to disable logging for the sensor by setting log interval = 24:00:00 and also exclude the data from transmission tx content = exclude.

##### Configuration

Wind result:

Speed index:

Direction index:

Configuration also allows you to specify what kind of result you're looking for from the wind processing. The available types are shown below. If you want more than one of the results, setup a separate measurement for each:

- ▶ Mean Speed Scalar
- ▶ Mean Magnitude Unit
- ▶ Mean Magnitude Wind

- ▶ Mean Direction Unit
- ▶ Mean Direction Wind
- ▶ STD Speed Scalar
- ▶ STD Direction Unit
- ▶ STD Direction Wind
- ▶ Min Speed Scalar
- ▶ Max Speed Scalar
- ▶ Max Direction
- ▶ Count
- ▶ Time of Max Speed

After picking the result, set the schedule for the calculation. The following schedule computes a 15 minute average of wind data collected every 60 seconds. The sampling interval (e.g. 60 below) must match with the interval set for the speed and direction sensors setup separately.

Schedule

Time:	<input type="text" value="00:00:00"/>	Averaging time:	<input type="text" value="00:15:00"/>
Interval:	<input type="text" value="00:15:00"/>	Sampling interval:	<input type="text" value="60.0"/>
		Subsamples:	<input type="text" value="1"/>

Here’s the setup for wind processing to compute a 10 minute average with data collected every 5 seconds. Again, the sampling interval 5 much match the measurement interval setup for the speed and direction sensors.

Schedule

Time:	<input type="text" value="00:00:00"/>	Averaging time:	<input type="text" value="00:10:00"/>
Interval:	<input type="text" value="00:10:00"/>	Sampling interval:	<input type="text" value="5"/>
		Subsamples:	<input type="text" value="1"/>

When you setup multiple results, make sure each has the same schedule.

The following sections give details on each of the results.

### 10.3.6.2 Wind Results

The Wind Measurement type processes data using Vector Average techniques that are needed to any sensor that has a circular discontinuity, such as a wind direction sensor with the crossover from 0 to 359 degrees. In these cases, simple averaging does not work -- the mean of 0° and 359° is 179.5°, which is clearly incorrect. Calculating a vector average provides a way around this problem.

When the data is processed the software automatically performs several different types of vector calculations, each conveying slightly different information. It is up to the user to pick which results meet the requirements for the measurement. While the wind processing is geared toward wind sensors, it could be used any time performing a vector average is desired.

The results of Wind processing are as follows, with vector math shown below.

Mean Speed Scalar – This is the scalar wind speed, not taking direction into account. The scalar average of 10mph for an hour and 20mph for an hour is 15mph, regardless of changing direction. This result is identical to the value you’d get with a simple average of the speed.

Mean Magnitude Unit – This is the vector average of the wind speed using unit vectors. The mean magnitude unit of 5mph at 0° for 1 hour and 100mph at 90° for 1 hour is 0.707. This is found by adding the two vectors, finding the magnitude of the resultant vector, and dividing by the number of vectors in the average (two, in this case). Since the mean magnitude unit is an average of unit vectors, it will always be between 0 and 1.

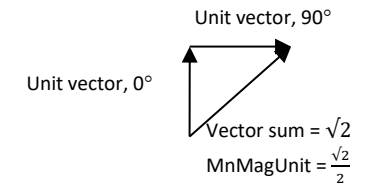

Mean Magnitude Wind – This is the vector average of the wind speed which takes direction into account. Here, the average of 10mph at 0° for 1 hour and 20mph at 90° for 1 hour is 11.2 mph.

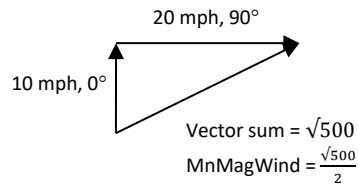

Mean Direction Unit – This is the wind direction (in degrees) not weighted for wind speed. Here, the average of 10mph at 0° with 20mph at 90° is 45°. This is the value you’d get with a simple average of the direction if no 0-360 crossover occurred.

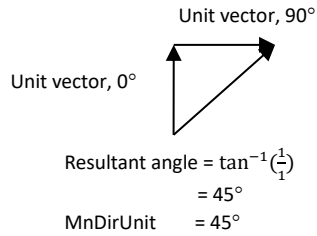

Mean Direction Wind – This is the wind direction (in degrees) weighted for wind speed. Here, the average of 10mph at 0° with 20 mph at 90° is 63.4°.

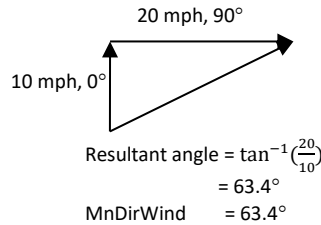

STD Speed Scalar – This is the standard deviation of the scalar wind speed.

STD Direction Unit – This is the standard deviation of the direction unit.

STD Direction Wind – This is the standard deviation of the direction wind.

Min Speed Scalar – This is the minimum of the scalar wind speed.

Max Speed Scalar – This is the maximum of the scalar wind speed.

Max Direction – This is the direction taken at the time the max speed is detected.

Count – This is the number of samples that have been taken.

Time of Max Speed – This is the time in seconds past midnight when the maximum speed was recorded.

### 10.3.7 Measure Type: Digital

Use the setting *Digital Type* to indicate what kind of sensor is connected.

#### 10.3.7.1 Digital Type

The following digital types are supported:

- ▶ Level 1&2
- ▶ Counter 1&2

- ▶ Frequency 1&2
- ▶ Period 1&2

The sensors should be connected to terminals #9 and #10 for digital input 1, and terminals #11 and #12 for digital input 2.

*Frequency* will have the system sample the input for 750ms. It will provide a result that is the average frequency of the input during that time span.

### 10kHz is the maximum supported input frequency.

When *Period* is the chosen type, the system will watch the input line for up to 10 seconds. The system stops watching as soon as one wave period is noticed on the input. Please note that a period measurement could take just over 20 seconds to complete (up to 10 seconds per edge of the signal). If such a slow signal may appear on the input, please make sure that the measurement interval is long enough (longer than 20 seconds) to prevent missing measurements.

Digital measurements also use the *Warmup* setting. If *Warmup* is not zero, then switched power and VREF will be turned on during a *Digital* measurement. See the section on analog measurement types for details on *Warmup*.

*Counter* type readings may be optionally de-bounced for 4ms using the Debounce setting. The 4ms de-bouncing eliminates false counts from tipping buckets and other devices with noisy switches.

*Counter* type readings may also be limited by a *rollover* value. With *rollover* set to 0, the counter will increase until it reaches 4,294,967,296 ( $2^{32}$ ). With *rollover* set to a non-zero value, the counter will be reset to 0 when it exceeds the *rollover* value. For example, if *rollover* is set to 9999, the counter will be reset to 0 on the 10000 count.

Please note that counter and tipping bucket measurements will keep counting even when recording is off.

Multiple measurements may be setup on the same digital input. For example, it is possible to setup both a tipping bucket rate and a tipping bucket accumulation on the same input.

That being said, some setups that share digital inputs will yield unpredictable results.

- ▶ Setting up any number of tipping bucket and counters on DIn2 with debouncing will work well.
- ▶ Setting up a tipping bucket and counters without debouncing on DIn2 will not work correctly as far as debouncing is concerned.
- ▶ Setting up a level measurement will work in combination with any other measurement.
- ▶ Setting up multiple frequency and period measurements on the same input will work as long as the measurements do not overlap.
- ▶ For frequency and period readings on the same input, one measurement must finish before a second one starts for the readings to be correct.



- ▶ For frequency and period readings, the system will not hold up one measurement until another completes.
- ▶ Overlapped frequency and period measurements are not considered a meaningful setup.
- ▶ Setting up a frequency or period measurement on the same input as a tipping bucket or counter will not work correctly.
- ▶ If you want to measure both frequency and count from an input you will need to jumper it to both digital inputs and setup one measurement for the counter (e.g. counter 1) and the other for a frequency (e.g. frequency 2).

Please see section [10.3.2.1 NOTES ON PRECIP RATE](#) for additional details relating to counts.

### 10.3.8 Measure Type: Meta

*Meta* measurements use the result of another measurement as their basis. Usually, a *Meta* measurement is used to average results of another measurement.

#### 10.3.8.1 *Meta Index*

This setting indicates which other measurement this *Meta* measurement refers to.

Why use meta measurements? If you had set up an hourly averaged temperature measurement, a *Meta* measurement could be set up to be the daily average of all those hourly readings.

- ▶ Measurement M1 (used for Hourly Temperature)
- ▶ Measurement Type: Analog
- ▶ Analog Type: 0-5VA
- ▶ Measurement Interval: 1 hour
- ▶ Averaging Time: 1 hour
- ▶ Sampling Interval: 1 second
- ▶ Measurement M2 (used for Daily Temperature)
- ▶ Measurement Type: Meta
- ▶ Meta Index: 1 (meaning it refers to measurement M1)
- ▶ Measurement Interval: 24 hours
- ▶ Averaging Time: 24 hours
- ▶ Sampling Interval: 1 hour

When scheduling meta measurements, take care that they occur at the same time or after the measurement they reference. If the meta and the reference are scheduled for the same time, the system will try to delay the meta measurement until the reference completes.

### 10.3.9 Measure Type: Manual Entry

Manual entry measurement types allow the user to enter a reading manually. That value becomes the reading of the measurement. The station will store the user entered value in the *Offset* field.

To enter a manual entry reading, use LinkComm's Calibrate button.



### 10.3.10 Measure Type: Internal Temperature

*Internal Temperature* measurements use a temperature sensor installed inside every unit. The reading provided is in degrees Celsius. To convert from Celsius to Fahrenheit set the slope to 1.8 and the offset to 32.

### 10.3.11 Measure Type: Modbus

The system may be setup to collect data from Modbus sensors. Please see section [19 MODBUS](#) for details.

## 10.4 Processing Settings

### 10.4.1 Slope

See Offset below.

### 10.4.2 Offset

Every measurement is computed by taking the sensor reading, multiplying it by slope and adding offset to it.

$$\text{Measurement result} = (\text{sensor output}) * \text{slope} + \text{offset}$$

Slope defaults to 1.0 and offset defaults to 0.0, meaning they will not affect measurement result by default.

Traditionally, when using an analog sensor, slope and offset are required to convert the voltage output by the sensor into desired units. The required slope and offset are provided by the sensor manufacturer.

**More complex equation processing is supported. Please see *Equations* below. Slope and offset are applied *after* equations.**



The reading before slope and offset are applied is referred to as the *raw* reading. For example, if an analog sensor were to provide a voltage of 2 volts, and the user had set up the *Slope* as 5 and *Offset* as 1, the final reading would be 11 ( $2 * 5 + 1$ ). The *raw* reading would be 2.

Calibrating a measurements results in changes to the offset setting.

### 10.4.3 Use Equation

Select "Use Equation" to allow an entry of the equation in the box below it. See the next section for examples.

### 10.4.4 Equation

Data collected from sensors may be processed through an equation. If the reading provided by the sensor needs more than just an offset and a slope applied, equations provide that functionality.

The field *Use Equations* can be set to enabled or to disabled. It determines whether equation processing is to be applied to the raw data. The field *Equation* can be set to an ASCII string no longer than 128 bytes (per measurement). That field contains the equation to be applied.

If both *Equations* and *Slope* and *Offset* are used, *Slope* and *Offset* are applied after the equation is processed.

For example, to convert Fahrenheit to Celsius, type into command line:

$$M1 \text{ EQUATION} = (X-32.0)*5/9$$

In the example above, X refers to the sensor reading.

LinkComm comes preloaded with equations for many types of sensors. To see the equations, press "Template..." and then select the desired equation from the drop-down box.

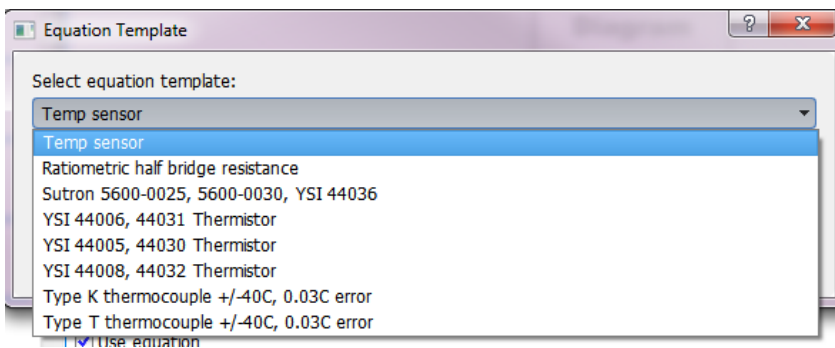

**Equation processing can take a while to complete (up to several seconds). If you are using a lengthy equation, the system may not be able to complete a measurement every second, or even every two seconds (see *Bad Schedule* in the Error section).**

#### 10.4.5 Equations: Syntax

The equation is expressed in terms of "X" which will be applied to incoming sensor data.

The expression is not case sensitive.

The following functions are available:

SIN, COS, TAN, ARCTAN, eg  $\text{COS}(90) = 0$

SQRT is square root, eg  $\text{SQRT}(9) = 3$   
To raise a number to a power, multiply it by itself. So, for example, to find x squared, input  $x*x$ .

EXP, if  $\text{EXP}(x) = y$ , then  $\text{LN}(y) = x$ , eg  $\text{EXP}(1) = 2.718282$   
LN, natural log, eg  $\text{LN}(2.718282) = 1$   
LOG, 10 based log, eg  $\text{LOG}(10) = 1$

INT returns the integral portion of a real number  
 $\text{INT}(11.456) = 11.000$   $\text{INT}(-1.345) = -1.000$   
FRACT returns the fractional portion of a real number.  
 $\text{FRACT}(11.456) = 0.456$   $\text{FRACT}(-1.345) = -0.345$   
ABS returns the absolute value of a real number.  
 $\text{ABS}(11.456) = 11.456$   $\text{ABS}(-1.345) = 1.345$   
RND provides random integer number between 1 and x.  
RND(100) will produce whole number between 1 and 100  
POLY is used to compute up to a 5th level polynomial equation:  
 $\text{POLY}(x, A, B, C, D, E, F)$  equates to  $A + Bx + Cx^2 + Dx^3 + Ex^4 + Fx^5$   
STEINHART(x, A, B, C) is used for Steinhart-Hart equations,  
where x is the resistance and result is the temperature in Celsius  
A, B and C are thermistor specific constants  
Steinhart result is computed like so:  $1/(A + B*\ln(x) + C*(\ln(x)^3)) - 273.15$

MINDAY returns minutes into the day.  
SECDAY returns seconds into the day.

VREF returns the exact analog voltage reference.

Comparisons can be performed using  $<$ ,  $>$ ,  $<=$ ,  $>=$ ,  $!=$ , and  $=$ . The result of a comparison is 1 for true or 0 for false.

Modulo can be performed using % operator, e.g.,  $10\%2=0$ ,  $10\%3=1$ .

The following bitwise boolean operators are supported: AND, OR, XOR, SHL, and SHR. The last two are shift-left and shift-right. For instance  $(X \text{ SHL } 4)$  would shift X left by 4 bits. AND & OR can also be used in logical expressions. For instance  $(X>100) \text{ OR } (X<50)$  would result in 1 if X is above 100 or below 50; otherwise it would result in 0.

The NOT operator is logical not bitwise. This means that NOT 0 is 1 and NOT 1 is 0. Also, the NOT of any non-zero number is 0, eg.  $(X \text{ AND } 128) != 0$  results in a 1 if bit 7 in X is set or 0 if bit 7 is clear. The bit mask 128 is  $2^7$ . This assumes bit 0 is the least significant bit. In general, the bit mask for any bit N is  $2^N$ .

OUTPUT(A,B,C,D) controls one of the 2 digital outputs or 3 switchable voltages.  
A is the conditional. If 0, no output happens; if 1 output activates.  
B is the output (1 = DOUT#1, 2 = DOUT#2, 3 = SWD#1, 4 = SWD#2, 5 = PROT12  
C tells whether to switch (0) or to pulse (1)  
if switching (C=0), D is direction to drive (0 open, 1 closed. line is open by default.)  
if pulsing (C=1), D is duration of the pulse in ms (20 - 10000)

Equations can also contain references to other sensors: eg.  $(X + M4)/2$ , would add X to the value of measurement M4 and divide by 2.

Use Prev1, Prev2, Prev3.. to access the previously made reading by said measurement. And, use DeltaT1, DeltaT2, Delta T3.. to access the amount of time in seconds between the most recent and the previous measurements.  
12:00:00 Measurement M1 has made a reading of 1.0

```
At this point, we do not have enough data to compute Prev1 or DeltaT1
12:05:00 Measurement M1 has made a reading of 2.0
At this point, M1 = 2.0, Prev1 = 1.0, DeltaT1 = 300
12:15:00 Measurement M1 has made a reading of 3.0
At this point, M1 = 3.0, Prev1 = 2.0, DeltaT1 = 300

Comments can be contained within braces { }. For example:
{convert from degrees Celsius to degrees Fahrenheit} X*9/5+32

Other examples:
SIN(X)+COS(X)+X^3+LOG(X)
(X>1000)*1000 + (X<=1000)*X {would limit the value so that it could never
be greater than 1000}
```

#### Troubleshooting:

The only true test of equation processing is to hit Force Measurement after the equation has been set.

### 10.4.6 Equations: Referencing other measurements

If you are setting up an equation that references another measurement, set the measurement type to meta, and make sure the measurement time and interval are the same as the referenced measurement. In the equation, reference the other measurements as M1, M2, M3, etc.

If you wish to use the analog reference voltage in the equation, use VREF.

For example, if you wanted to trigger a sampler via the digital output when a conductivity sensor reading exceeded 80, do the following:

- ▶ Setup measurement M1 to collect data from the conductivity sensor.
- ▶ Setup measurement M2 as a Meta measurement, with the Meta Index set to 1 in order to reference M1. This ensures that M2 will wait for M1 to complete before producing a result. Make sure the schedule for M1 and M2 is the same.
- ▶ Setup the equation of M2 to `OUTPUT(M1>80, 1, 1, 2000)`. That will cause the system to pulse DOUT#1 for 2 seconds whenever the conductivity sensor exceeds 80.

## 10.5 Alarm Settings

Alarms are used to send immediate notifications when sensor readings read a certain threshold. They can also be used to control an output (please see section [12.3 DIGITAL OUTPUT](#)).

When a measurement is made, if alarms are enabled for that measurement, the sensor reading is compared to the *Alarm Threshold* and *Alarm Deadband*. If certain criteria are met, the alarm triggers (see below).

- ▶ When a sensor reading reaches a certain threshold, the station is said to **go into alarm**.
- ▶ While that sensor reading stays above the threshold, the system is considered to be **in alarm**.
- ▶ After the sensor reading drops below the threshold, the system **goes out of alarm**.

When the station is in alarm, it is noted in the station's status.

When a station goes into or out of alarms, the reading causing the alarm is logged. Additionally, an event is recorded in the log.

The station can be set up to send transmissions when it goes into alarm. Alternatively, the station can be set up to make a transmission when it goes into alarm **and** to make another transmission when it goes out of alarm.

All enabled transmissions of the Alarm kind will trigger with alarms.

The system can control its digital output based on alarm conditions. See section [12.3 DIGITAL OUTPUT](#) for details.

Most sensor readings cause alarms at the time the measurement is scheduled. If a temperature sensor is set up for alarms with a *Measurement Interval* of 15 minutes, the station will read the sensor every 15 minutes and decide whether to go into alarms.

Some sensors, including the tipping bucket and sensors setup as digital counter and level, can cause instant alarms. When the tipping bucket tips, the system is immediately notified. If the tip causes an alarm condition, the station goes into alarms right away, even if it was not time to make a measurement.

Each measurement may be set up with up to three different alarms. This way, it is possible to get an alarm when the stage reaches 3 feet, another alarm when it reaches 4 feet, and a third alarm when it reaches 6 feet.

If more than three alarms are needed for one sensor, set up two measurements to read the same sensor, but give them different alarm conditions.

#### 10.5.1 Alarm 1, Alarm 2, and Alarm 3

Each of these settings can have one of the following values

- ▶ Off
- ▶ High
- ▶ Low
- ▶ ROC

These settings are used to determine what kind of computation is made when checking a sensor for alarms. Read on for a complete explanation.

#### 10.5.2 Threshold 1, Threshold 2, and Threshold 3

The threshold is a value that is compared to the sensor reading in order to determine whether to go into or out of alarms.

#### 10.5.3 Deadband

The *Deadband*, along with the *Threshold* value is used to compute whether the measurement will go **out of alarms**. Deadband helps the system ignore noise on the input that would cause the measurement to go in and out of alarm on each measurement.

For example, if a High Alarm with the Threshold of 10.5 and a Deadband of 3.0 were setup, the system would go into alarm once the reading was equal to or greater than 10.5. The system would stay in alarms as long as the reading was equal to or greater than 7.5. Once the reading dropped below 7.5, the system would go out of alarms.

#### 10.5.4 Alarm Tx Mode

*Alarm Tx Mode* determines whether transmissions are made when the station goes (into alarm) or (when it goes into *and* out of alarm).



- ▶ If the *Alarm Tx Mode* is *Tx In*, the station will only make a transmission when it goes into alarm.
- ▶ If the *Alarm Tx Mode* is *Tx In And Out*, the station will make a transmission when it goes into alarm, and it will make another transmission when it goes out of alarm.
- ▶ Random and Alarm transmissions are the only types of transmissions triggered by alarms.
- ▶ The telemetry setting Alarm Interval can be used to keep transmitting as long as a station is in alarm. Please see section [11 TELEMETRY SETUP](#) for details.

**ROC alarms setup for *Since Last Tx* do not generate out of alarm events or transmissions.**

#### 10.5.5 Alarm Logging

- ▶ If Alarm Logging is set to Every Measurement, the system logs on the Measurement Interval.
- ▶ If Alarm Logging is set to Use Logging Interval, the system logs on the Logging Interval. This setting is only relevant if the customer setup the *Measurement Interval* to be more frequent than the *Logging Interval*. In that case, the system can be configured to log more frequently when it is in alarm.

Here is an example of a system setup to log more frequently while in alarms. The system is set up to read the temperature sensor every two minutes and check for alarms. If the temperature exceeds 20 degrees, the system will go into alarm. The system will log once every two minutes when in alarm, and once an hour when not in alarm.

Measurement Interval = 00:02:00  
Logging Interval = 01:00:00  
Alarm Logging = Every Measurement  
Alarm 1 = Hi  
Threshold = 20

#### 10.5.6 Alarm ROC Interval

This setting affects ROC (Rate of Change) alarms. When set to *Since Last Meas* the system will compare two consecutive scheduled readings when deciding whether to trigger alarms.

When it is set to *Since Last Tx*, the system will compare the current sensor reading with the last transmitted reading. If there is no past transmission, the first reading made after boot up is used.

## 10.6 Alarm Computation Details

This section contains details on how the system decides whether to go into alarms. The section is broken down by the user chosen *Alarm Type* setting:

### 10.6.1 Hi Alarm

When the Alarm Type is set to Hi, if the sensor reading is greater than or equal to Alarm Threshold, the station goes into alarm.

That station will go out of alarm when the sensor reading goes below Alarm Threshold minus Alarm Deadband.

#### Hi alarm scenario:

- ▶ System measures stage every 15 min
- ▶ Hi Alarm threshold is at 2ft
- ▶ Tx Alarm Interval is 5min
- ▶ Once stage exceeds 2ft, the system sends out an alarm transmission
- ▶ As long as stage is above 2ft, the system will send out alarm transmissions every 5min
- ▶ Note how even though the measurement interval is 15min, the transmissions are fired off every 5min

### 10.6.2 Low Alarm

When the Alarm Type is set to Low, if the sensor reading is less than or equal to Alarm Threshold, the station goes into alarm.

That station will go out of alarm when the sensor reading goes above Alarm Threshold plus Alarm Deadband.

### 10.6.3 ROC Alarm

ROC stands for Rate Of Change. ROC alarms compare the current measurement reading with a past reading. If *Alarm ROC Interval* is *Since Last Meas*, the past reading is the last scheduled reading made according to *Measurement Time* and *Measurement Interval*.

If *Alarm ROC Interval* is *Since Last Tx*, the past reading is the one that was included in the last alarm transmission. If there is no past transmission, the first reading made after boot up is used.

If the absolute difference between the two readings (absolute of current reading minus past reading) is greater or equal to the *Alarm Threshold*, the station goes into alarm.

The same station goes out of alarm if the absolute difference between the two readings (absolute of current reading minus past reading) is less than the *Alarm Threshold* minus *Alarm Deadband*.

**Exception:** ROC alarms setup for *Since Last Tx* do not generate out of alarm events or transmissions.

**ROC alarm scenario:**

- ▶ System measures stage every 15 min
- ▶ ROC Alarm threshold is at 2ft
- ▶ Tx Alarm Interval is 5min (not relevant)
- ▶ If the most recent stage minus the prior sample is 2ft or greater, the system sends out an alarm transmission.
- ▶ No transmissions are sent until the next measurement time (15 min)
- ▶ At the next measurement time, another ROC computation is made. If current minus prior is 2ft or greater, another transmission is made.
- ▶ Note how the Tx Alarm Interval is not relevant to this scenario.

## 10.7 Logging Settings

### 10.7.1 Logging Interval

*Logging Interval* dictates how often to log sensor data.

Change the *Logging Interval* to measure sensors more frequently than to log them. This is useful for alarm setups, in which you want to check the water level once a minute in order to detect fast-rising water, but one only wants to log the water level data once an hour. For this scenario, the *Measurement Interval* would be one minute, and the *Logging Interval* would be one hour.

For alarm conditions, it is possible to set *Alarm Logging* to *Every Reading*. That would result in the water level in the example above being logged once a minute when the system was in alarm, and logging once only once an hour when not in alarm.

If *Logging Interval* is set to zero, the station will log every measurement. It is the same as having the *Logging Interval* equal to the *Measurement Interval*.

LinkComm provides a *Log All* checkbox: when checked, the station will measure and log at the *Measurement Interval*.

Having a *Logging Interval* that is shorter than the *Measurement Interval* is a bad setup.



#### **Only logged readings may be transmitted.**

It is not possible to entirely disable logging of measurement results. However, one can set the logging interval as slow as once a day.

### 10.7.2 Log Error Value

When the system cannot get valid data from a sensor (more specifically, when a sensor failure error occurs), the system will change the sensor reading to match the user-set *Log Error Value*, which defaults to -99999. Such atypical numbers are used to attract the user's attention when viewing the log.



## 10.8 Transmission Data Content Settings

### 10.8.1 Tx Data Content

*Tx Data Content* indicates which readings to include in the transmission. Each measurement has multiple *Tx Data Content* settings: one for each transmission.

The options are All Logged, Individual, Last, and Exclude.

- ▶ By selecting *All Logged*, measurements that are logged according to the measurement schedule are transmitted. Only readings made since the last transmission are included. This setting is dependent on the *Logging Interval* setting.
  - ▶ Please note that if the system is logging data more frequently due to being in alarms, the extra data is NOT transmitted. To include extra data created by alarms, please use the *Last* option.
  - ▶ The only data points transmitted are those made according to the measurement time and logging interval settings.
- ▶ See below for the *Individual* setting.
- ▶ *Last* means to transmit a set number of the most recent readings (determined by *Number of Values to Tx*).
  - ▶ Use *Last* for alarm and random transmissions to ensure that the value that caused alarms is transmitted!
  - ▶ *Last* is the only option that may be used to transmit data that is not collected based upon the measurement schedule.
- ▶ By selecting *Exclude*, no readings of this measurement are transmitted.
- ▶ *All Since Last Tx* includes all logged data since the last transmission. *All Since Last Tx* selection is different from *All Logged* in that it ignores measurement scheduling. *All Since Last Tx* will parse through the log and include every logged entry of the measurement.
  - ▶ This option is useful when the logging interval changes due to alarms or scripts.
  - ▶ This option results in a variable amount of data in the transmission. Only certain *Tx Format* options are suitable for *All Since Last Tx*. Timestamps of transmitted data using SHEF, some Pseudobinary, and all formats that do not give each reading its own timestamp, may be incorrect. CSV and MIS will work correctly. Pseudobinary B is not suitable.
  - ▶ With *All Since Last Tx*, all estimates of data content may be incorrect.
  - ▶ With *All Since Last Tx*, newest data in transmission may be at (transmission time - *Sensor Encoding Time*). Oldest data will be newer than (last transmission time - *Sensor Encoding Time*).
  - ▶ *Skip First Missing* does not work with *All Since Last Tx*.

### 10.8.2 Tx Data Time, Interval, and Duration

If *Individual* is selected for *Tx Data Content*, the fields *Tx Data Time*, *Tx Data Interval*, and *Tx Data Duration* will appear, allowing the choice of what data to include in the transmission.

These options may be used to measure and log data more frequently than to include them in transmissions. They may also be used to transmit redundant data.

For example, if one wanted to measure and log data once a minute, one would set the *Measurement and Logging Intervals* to one minute. Since it may be expensive to transmit all that data, one can choose to transmit only every 10th reading by setting the *Tx Data Interval* to 00:10:00.

The example below uses Measurement and Logging Intervals of 15 minutes. Tx Data Content is set to Individual.

Timeline:

- ▶ 11:00 measure and log data
- ▶ 11:15 measure and log data
- ▶ 11:30 measure and log data
- ▶ 11:45 measure and log data
- ▶ 11:50 transmission

Setup options:

- ▶ The user could set up to transmit all four of those values:
  - ▲ Tx Data Content = All Logged
- ▶ The user could set up to transmit the data from 11:15 and 11:45:
  - ▲ TX Data Time = 00:15:00, Tx Data Interval = 00:30:00
- ▶ The user could set up to transmit only the data from 11:45:
  - ▲ Tx Data Time=00:45:00, Tx Data Interval = 01:00:00
- ▶ The user could set up to transmit only the data from 11:00:
  - ▲ Tx Data Time=00:00:00, Tx Data Interval= 01:00:00
- ▶ Setup to transmit the most recent two readings from 11:30 and 11:45
  - ▲ Tx Data Content = Last, Number of Values to Tx = 2



***Tx Data Interval must be a multiple of the Logging Interval. Setting Logging Interval to 15 minutes and Tx Data Interval to 20 minutes is not a good idea.***

The *Tx Data Duration* setting may be used to include redundant data in a transmission. It controls how much data is included in a transmission. On a system with hourly transmissions, the system would transmit an hour's worth of data by default. If *Tx Data Duration* were set to two hours, then the transmission would contain two hours worth of data. In effect, this means that system will be transmitting redundant data.

When *Tx Data Duration* is zero, and it is zero by default, one *Tx Scheduled Interval* worth of data is transmitted. i.e., if you transmit once an hour, you will get an hour's worth of data.

Coupled with the *Tx Data Interval*, the *Tx Data Duration* may be used to fine tune the data content of the transmission. Example setup:

- ▶ The setup measures a sensor every five minutes.

- ▶ The setup makes hourly GOES transmissions
  - ▶ Each GOES transmission has 2 hours worth of 15-minute data (8 data points)
- ▶ The setup also does Iridium transmissions every 30 minutes
  - ▶ Every Iridium transmission has 30 minutes worth of 5-minute data (6 data points)

```
M1 Interval = 00:05:00

TX1 Satellite Type = GOES 300
TX1 Scheduled Interval = 01:00:00
M1 Tx Data Content1 = Individual
M1 Tx Data Interval1 = 00:15:00
M1 Tx Data Duration1 = 02:00:00

TX2 Radio Type = Iridium
TX2 Scheduled Interval = 00:30:00
M1 Tx Data Content2 = Individual
M1 Tx Data Interval2 = 00:05:00
M1 Tx Data Duration2 = 00:30:00
```

The *Tx Data Duration* setting was added in version 8.21.

## 10.9 Measurement Setup Defaults

To change the setup of a single measurement to its defaults, type M1 SETUP DEFAULT on the command line to reset measurement one. This will affect only one measurement.

## 10.10 Measurement Calibration

There is an easy way to change the current reading of any measurement: press the Calibrate button on the Measurements tab in LinkComm and enter the desired reading.

Via command line, type M1=10.5 to set the reading of measurement one to 10.5

This calibration procedure has the effect of modifying the measurement's *Offset*.

When a sensor is calibrated, the system will log several events:

```
M2 = 30.5
Measurement M2 STAGE set to 30.5

08/20/2019,15:26:36,Calibration Meas,2,,G
08/20/2019,15:26:30,Cal before STAGE,15.0,,G
08/20/2019,15:26:36,Cal after STAGE,30.5,,G
```

Please note that prior to version 8.28, the system logged measurement readings (rather than events). This resulted in the transmission of calibrated values if Tx Data Content was set to Last. Additionally, prior to 8.28, calibration could trigger alarms. That is no longer the case.

## 10.11 Multiple Measurements Using the Same Sensor

You can set up multiple measurements with the same input. For example, to log the daily rainfall and the rainfall during the last hour, set up two measurements: one as a precipitation rate with an interval of one hour, and another as precipitation rate with an interval of one day.

To log the daily temperature **and** the hourly temperature, only one physical temperature sensor is needed. Set up two measurements with the same setup; change the *Measurement Interval* and the *Averaging Time* and use a different *Label* for each. One would happen once a day (*Measurement Interval* 24 hours, *Averaging Time* 24 hours), and the other once an hour (*Measurement Interval* 1 hour, *Averaging Time* 1 hour). It would be a good idea to set up the sampling Interval to one minute for both sensors in order to save power. See section [10.2.3 AVERAGING TIME, SAMPLING INTERVAL, SUBSAMPLES, AND RESULTS](#).

If two separate measurements are scheduled to measure the same sensor at the same time (as they will in the examples above), only one reading of the sensor is made, and the result is shared by both measurements.

# 11 Telemetry Setup

---

XLink features a built-in modem which is used for telemetry. XLink will collect sensor data and later transmit that data to a remote destination. The telemetry setup manages the transmission of data.

Just as there are multiple measurements that may be setup, there are multiple telemetry setups. Each setup is independent of another. Multiple telemetry setups are needed in order to transmit data to different servers over the cellular network. Multiple setups are needed to allow for both scheduled and alarm transmissions.

Each telemetry setup is configured and enabled separately. If no telemetry setups are enabled, the system will show an error on the dashboard.

We use the shorthand name Tx to mean transmission. ReTx means retransmission.

Please note that the transmission data content is governed by measurement setup. Please see section [10.8 TRANSMISSION DATA CONTENT SETTINGS](#) for details.

## 11.1.1 Enable

This is the master switch for enabling the telemetry setup.

For Scheduled transmissions, the Enable setting turns on scheduled (sometimes called self-timed) transmissions. If this setting is enabled, the system will periodically deliver sensor data to the designated destination. If disabled, the system will not initiate any scheduled transmissions.

For Alarm transmissions, the Enable setting determines whether a transmission is sent when the system is affected by measurement alarms.

## 11.1.2 Radio Type

Which radio is to be used for the telemetry? Available radios may include Iridium and Cell, depending on the radio installed in the station.

## 11.1.3 Kind

Several different transmission kinds may be setup:

- ▶ Scheduled
- ▶ Alarm

Please read on for a description of transmission kinds.

## 11.1.4 Scheduled Transmissions

Scheduled transmissions happen on a periodic basis controlled by the Scheduled Time and Scheduled Interval settings. If the Interval is set to one hour, there will be 24 transmissions per day, every day.

When the station should make a transmission depends on the transmission schedule. The time is computed based upon these settings:

- ▶ Scheduled Time
- ▶ Scheduled Interval

The interval controls how frequently the transmission is made, and the time controls when the transmission is started.

- ▶ Example: Time 00:00:00 interval 00:10:00
  - ▶ 00:10:00 transmission process starts
  - ▶ 00:20:00 transmission process starts
  - ▶ 00:30:00 transmission process starts
  - ▶ and every ten minutes afterwards...
  
- ▶ Example: Time 00:00:30 interval 00:05:00
  - ▶ 00:00:30 transmission process starts
  - ▶ 00:05:30 transmission process starts
  - ▶ 00:10:30 transmission process starts
  - ▶ and every five minutes afterwards...

The transmission process is not instantaneous. At the scheduled time, the transmission process will start. That process includes formatting the data content, powering on the modem, waiting for the modem to acquire a good signal, etc. It usually takes less than one minute for the transmission to start. If the modem is on prior to the transmission, it takes only a few seconds to start. The Listening setting may be used to keep the modem on all the time.

Make sure to have the transmission scheduled a short while after the measurements are completed. If the measurements happen at the 15 minute mark, set the transmission time to 16 minutes to ensure the measurements are completed before the transmission process starts.

### 11.1.5 Alarm Transmissions

When setup for Alarm transmissions, the system will make transmissions as the station goes into and optionally out of alarms.

The measurement setup for alarms should be configured with the Tx Data Content set to Last to make sure that the reading that caused the alarms is transmitted.

#### 11.1.5.1 Alarm Interval

The Alarm Interval setting is relevant to Alarm transmissions only. If not zero, the system will repeat transmissions at the Alarm Interval for as long as the station is in alarm.

Additionally, if not zero, the Alarm Interval dictates the minimum time between transmissions. If set to one hour, Alarm transmissions will not happen more than once an hour no matter how often the station goes into alarms.

If the Alarm Interval is zero, alarm transmissions are made once when the station enters alarms, and optionally a second time when the station goes out of alarms.

### 11.1.6 TX Format

The TX Format field controls how the sensor data is formatted in the message. Each format has its own distinctive advantages. Choices:

- ▶ Pseudobinary B, C, and D
- ▶ SHEF and SHEFFIX
- ▶ ASCII Column
- ▶ ASCII Sensor
- ▶ CSV
- ▶ MIS

SHEF, SHEFFIX, and Pseudobinary formats are traditionally used for GOES applications. They are characterized by a short message length and little to no metadata.

MIS and CSV formats include much more metadata and result in longer messages. They are typically transmitted over the cellular network.

**The specifics of formatting are covered in greater detail in [16 TRANSMISSION DATA FORMATS](#).**

To see what your data will look like after it has been formatted, click the “Show Tx Data” button in the Telemetry Status section of the telemetry tab.

#### 11.1.6.1 Date Format

The Date Format setting is used for the MIS format (as per section [16.8 MIS](#)). It defaults to YYYY/MM/DD. It may be used to change the format of the date in the transmitted data.

## 11.2 Cell Setup

XLink may be equipped with a cell modem. A cellular modem is similar to equipment found in a mobile phone.

The station will use the cellular modem to connect to the internet and deliver sensor data to a server. If the station is setup to allow incoming TCP/IP connections, the station may be accessed remotely over the internet. The modem is also used to send and receive SMS (text) messages.

Please make sure to read section [13.2 CELLULAR TELEMETRY](#) for additional information.

Some of the cell settings are found on the Telemetry tab and are specific to a single telemetry setup. Additional settings are found on the Other Setup tab of LinkComm; those are global settings.

### 11.2.1 Data Source

This setting determines whether the station will transmit measured sensor data (traditional setup) or files (created by Python scripts and saved to a specific folder on the SD card). Options are

- ▶ Measurement
- ▶ File

This setting should only be changed to File in order to transmit files created by Python scripts on the SD card.

**Please leave this setting at the default Measurement in order to transmit sensor data.**

If Data Source is set to File, FTP is the only available Tx Mode. Please see section [13.2.6 FILE TRANSMISSIONS](#) for more info.

#### 11.2.1.1 Max Files Per Tx

Relevant only when Data Source is set to File. Please see section [13.2.6 FILE TRANSMISSIONS](#) for more info.

This setting may be used to limit the number of files transmitted with each transmission.

#### 11.2.1.2 File Expiry Period

Relevant only when Data Source is set to File. Please see section [13.2.6 FILE TRANSMISSIONS](#) for more info.

This setting is used to ensure that the system does not transmit outdated files. At transmission time, the time the file was created is checked. If the file was created more than File Expiry Period ago, the file is deleted.

The File Expiry Period setting is expressed in minutes.

### 11.2.2 Tx Mode and Protocol

When the station has access to the internet, it may be setup to deliver sensor data to a server. Several different modes of connecting to a server are provided:

- ▶ TCPIP
  - ▶ This method uses raw socket communications. The station connects to a port on the server and delivers the sensor data.
  - ▶ If *Protocol* is set to *HydrometCloud*, there is a bit of handshaking between the station and the server (see [16.11.1 HYDROMET CLOUD PROTOCOL](#)). This option should be selected when transmitting to Hydromet Cloud.
  - ▶ If *Protocol* is set to *None*, the raw sensor data is delivered to the server. Use this option if you are hosting your own server.
  - ▶ See the section [16.11 TCP/IP SESSION](#) for details on the connection.
  - ▶ *TCPIP* mode used to be called *Internet Only* prior to version 8.21.
- ▶ FTP
  - ▶ File transfer protocol is a standard means of transferring files. When this option is chosen, the station will connect to an FTP server and deliver sensor data as a file.



- ▶ FTPS is also supported – enable the *Secure* option to use FTPS.
- ▶ The system supports explicit FTPS.
- ▶ HTTP
  - ▶ The station may deliver data to Hydromet Cloud using HTTP or HTTPS. Enable the *Secure* option to use HTTPS.
- ▶ SMS
  - ▶ If *Tx Mode* is set to *SMS*, the station will send transmission data via SMS (text messages) to up to three telephone numbers, as specified by *SMS Tx Phone*.

#### 11.2.2.1 *Main Server and Backup Server*

If the station is setup to deliver data to a server, the system will use the modem to get an internet connection. Once the connection is established, the system will connect to the *Main Server* in order to deliver data. Failing that, it will try the *Backup Server*. A transmission is considered a success if either of those servers receives the data.

The server may be expressed as a name (such as [www.HydrometCloud.com](http://www.HydrometCloud.com)) or an IP address (such as 10.0.0.1).

To deliver to more than one server, setup multiple transmissions for cell telemetry, each with a different *Main Server*.

To not use a *Backup Server*, leave the field blank.

#### 11.2.2.2 *Server Port*

What port to connect to on the *Main and Backup Servers*. Note that both FTP and FTPS traditionally use port 21, FTPS uses 990, HTTP uses 80, and HTTPS uses 443.

#### 11.2.2.3 *Server Username*

If a login is required on the server, please enter it here. FTP traditionally requires a username. TCPIP protocols do not use the username. If a name is not required, leave the field blank.

#### 11.2.2.4 *Server Password*

If the *Main and Backup Servers* are protected by a password (sometimes called a shared secret), it must be entered in this field. If it is not, the station will not be able to deliver sensor data.

If the server does not provide password protection, leave this field blank.

#### 11.2.2.5 *Server Path*

HTTP communications require that the correct path be set.

- ▶ If you are using Hydromet Cloud, the path will be provided once a Hydromet Cloud account is setup. Only HTTP uses this setting.
- ▶ If you are using Hydras, please use the path provided when the Hydras account is setup. You must include either the *ws* or the *uid* that was provided. Here are two examples of valid paths:
  - ▶ `/ottml.htm?uid=XLINK`

- ▶ /ottml.htm?ws=99

#### 11.2.2.6 FTP Path

This setting may be used to deliver FTP data to a specific path on the server. Please note that the station CANNOT create directories. The path must exist on the FTP server before the station can deliver files to it. An example of a path: "Rain\_station/A2/B12".

When it delivers data to an FTP server, the station creates a new file with each delivery. The file name will be made up of the Station Name and the time of the transmission:

- ▶ StationID\_YYYYMMDDHHMMSS
- ▶ Station ID is the first 15 characters from the Station Name setting. (prior to version 8.28, it was only 10 characters).
- ▶ The rest of the filename is based on the date and time of the transmission.
- ▶ The file extension is based on the Tx Format setting: "shf", "pbn", "csv", "mis"

#### 11.2.2.7 SMS Tx Phone A, B, and C

When it is time to make a scheduled transmission, if *Tx Mode* is set to *SMS*, the station will send data to the phone number(s) set up in *SMS Tx Phone*.

If you want data delivered to just one phone, enter it into *SMS Tx Phone A*, and leave *SMS Tx Phone B* and *C* blank. To deliver to a second phone number, enter the number in *SMS Tx Phone B*. Use *SMS Tx Phone C* to deliver data to a total of three different numbers.

### 11.2.3 Cell Global Settings

These settings are found on the Other Setup tab of LinkComm. Please read on for a list and description of each setting.

#### 11.2.3.1 Cell Listening

If enabled, *Cell Listening* will cause the station to keep the cellular modem on all the time. This makes it possible to connect to the station with LinkComm over the internet at any time. It also ensures that incoming SMS are received immediately. However, it significantly increases the power consumption.

If *Cell Listening* is not enabled, the station will only power on the modem when it makes transmissions, when it checks for messages, when it boots up, and when the operator is inspecting the station.

Listening is automatically turned on by the station for 10 minutes at these times:

- ▶ At boot up
- ▶ When the station is connected to, whether via USB, over the modem, or over Wi-Fi
- ▶ When an SMS is received

Additionally, listening is on for 5 minutes

- ▶ After a transmission is completed

When the front panel button is pressed, and when the station goes into alarms, listening is automatically turned on for one hour.

When the cell modem is powered on, the station will act as a TCP/IP server, ready to accept incoming connections from LinkComm if *Accept TCPIP Connects* is enabled. Additionally, the station will be ready to accept incoming SMS if the *Accept SMS* setting is enabled.

If *Accept TCPIP Connects* is enabled, the station will listen on port 3001. Only one connection may be established at a time.

If power consumption is of concern, setup the station to periodically check for SMS messages (see *Msg Interval* below). Shorter intervals result in higher power consumption. Longer intervals mean a longer response time. For example, if *Msg Interval* is one hour, it may take up to one hour for the station to receive a message.

Once there is a need to connect to the station, send a message to the station asking it to start listening and to accept TCP/IP connections. That message should say

```
!ACCEPT TCPIP CONNECTS = ON
!CELL LISTENING=ON
```

Once the station receives the message, it will send a reply. From that point on, the station is online and available to connect. It will stay online until listening is turned off. Use LinkComm to connect to the station and perform the appropriate operations.

Do not forget to turn off listening and TCP/IP connects before disconnecting.

To have the station only turn on listening for a limited time period, use the LISTEN command. For example, to have the station go online for two hours send an SMS saying

```
!ACCEPT TCPIP CONNECTS = ON
!LISTEN 7200
```

Two hours is 7200 seconds.

Please note that the *Msg Interval* setting (described below) determines how often the station checks for incoming messages. If that is set to six hours, it means that it may take up to six hours before the station receives incoming messages.

#### 11.2.3.2 *Accept TCPIP Connects*

This setting controls whether the system will *ever* open a listening socket in order to accept incoming TCP/IP connections on port 3001. Normally, that port is used to allow LinkComm to connect to the station remotely. *Accept TCPIP Connects* is enabled by default.

Disabling incoming TCP/IP connections increases the security of the station. This setting is new with version 8.21.

### 11.2.3.3 *Whitelist*

In order to further protect the station from unwanted access over the internet, whitelisting may be used.

A whitelist contains a list of IP addresses (or address ranges). Unless a client is on the list, the client will not be able to connect to the station using TCP/IP. Please note that if Accept TCPIP Connects is off, whitelisting is not relevant.

Whitelisting is controlled by the following settings

- ▶ **Whitelist Enable**
  - ▶ This master switch controls whether whitelisting is enabled. The default is off.
  - ▶ If this setting is off, whitelisting is not used by the station and any client may connect (assuming other settings such as Accept TCPIP Connects are set)).
  - ▶ If you enable whitelisting, you must add some IP addresses to the list.
- ▶ **Remote Whitelist Change**
  - ▶ This setting controls whether any of the whitelist settings may be changed remotely. The default is on, allowing remote changes.
  - ▶ If you wish to lock the station down even further, change this setting to off while on site. Once it is off, the whitelist is fixed and may only be changed on site.
  - ▶ The Remote Whitelist Change setting may never be changed remotely – you must be on site to modify it.
- ▶ **Whitelist IP1, Whitelist IP2 .. Whitelist IP16**
  - ▶ There are 16 whitelist IP address/range settings
  - ▶ The notation used for IP addresses is xxx.xxx.xxx.xxx/yy
  - ▶ xxx are decimal digits. Alternatively, xxx may be set to wildcard \* making it a range.
  - ▶ /yy is for CIDR notation - it is optional
  - ▶ E.g. of a single IP address: 192.168.3.1 – this allows only one IP address to access the station.
  - ▶ E.g. of a range of IP address range using a wildcard: 192.168.3.\* - this allows all addresses from 192.168.3.0 to 192.168.3.255 to access the station. The wildcard must be last byte of the IP address.
  - ▶ E.g. of the same range if IP addresses using CIDR notation: 192.168.3.0/24

Please talk to your network administrator and ensure that you are using the correct IP addresses.

The station will report the IP address of the last client that accessed it in the Radio Diagnostics. It will also count the number times client connections were blocked and accepted:

```
Total client connects: 4 total, 1 today
Total client blocks: 9 total, 9 today
Last client IP 192.168.3.153 accepted at 2019/08/07 18:36:43
```

The total number of accepted and blocked clients will be logged with the daily events.

Whitelist support was added with version 8.28.

#### 11.2.3.4 *Accept SMS*

*Accept SMS* controls whether the system will accept any incoming SMS. It is enabled by default.

If *Accept SMS* is disabled, the station will not accept any SMS. Disabling this setting strengthens the security of the station.

Prior to version 8.21, there was a setting called *SMS Listening Only* which prevented the station from opening a listening socket. That setting was replaced by *Accept SMS* and *Accept TCPIP Connects*.

#### 11.2.3.5 *Cell Msg Interval*

The *Cell Msg Interval* setting dictates how often the station will check for incoming SMS messages.

This setting is near identical to the [IRIDIUM MSG INTERVAL](#) setting. Please read section [11.3.1.2](#) for details on message checking.

#### 11.2.3.6 *Cell Enable*

The *Cell Enable* setting may be used to completely disable the Cell modem. If disabled, the station will never power on the modem, and no cell features will be available. This setting is the equivalent of disconnecting the modem from the board. It may not be set remotely.

#### 11.2.3.7 *Cell Notifications Enable*

This setting controls whether notifications are sent via SMS when certain events happen. Please see section [13.2.5 SMS NOTIFICATIONS](#) for details.

#### 11.2.3.8 *Cell Time Sync Enable*

This setting controls whether the station will synchronize its clock to cell network time automatically.

The station will synchronize to UTC time. Please modify the [LOCAL TIME OFFSET](#) setting to use local time as per section [12.7.1](#).

This setting was introduced in version 8.28. The default value for this setting is on, meaning that your station will automatically synchronize its clock. Please note that upgrading an older unit to version 8.28 will not automatically enable the time sync in order – you will need to manually switch on the Cell Time Sync Enable setting.

#### 11.2.3.9 *Additional Cell Settings*

Changing these settings is not normally required. In fact, incorrect settings may result in the Cell modem not working!

- ▶ Cell APN
  - ▶ This is the service provider's APN (Access Point Name). If the station is not able to get online, the APN may be incorrectly set. Please note that leaving this setting blank will work with most providers.
- ▶ Cell SIM PIN

- ▶ Some SIM cards are locked with a PIN. This setting holds the value to give to the SIM when turning the modem on. A locked SIM will not work without a PIN and the station will report a Bad PIN error.
- ▶ Cell Username
- ▶ Cell Password
  - ▶ Some providers require that a user name and password be provided in order to connect to the internet.
- ▶ Network selection
  - This setting only pertains to the MOD-7 North America LTE modem. Systems with other modems do not use this setting.
  - If the SIM card network provider is Verizon, you should switch this setting to Verizon. For all other carriers, choose AT&T. The default value is AT&T.
  - The system requires a reboot after changing this setting.
- ▶ SIM selection
  - This setting only pertains to the MOD-6 global CAT M1 modem and the MOD-7 North America LTE modem. Systems with other modems do not use this setting.
  - The setting chooses between a traditional SIM card which is inserted into the modem, and the embedded SIM built into every modem. The embedded SIM cannot be removed from the modem. The default setting is the SIM card.
  - The embedded SIM only works on Verizon networks. The embedded SIM may not be used with other network carriers.
  - The system requires a reboot after changing this setting.

## 11.3 Iridium Setup

XLink may be equipped with an Iridium modem. If such hardware is available, scheduled and alarm transmissions via the Iridium modem are possible.

Additionally, the station can receive messages via the Iridium modem. These messages can be used to check station status, change station setup, request re-transmissions of logged data, and more. Iridium messages are limited in bandwidth and are time delayed. Email is generally used to send commands to the station via Iridium. LinkComm cannot be used to send messages via Iridium.

Please see section [13.1 IRIDIUM TELEMETRY](#) for more details on Iridium.

Some of the Iridium settings are found on the Telemetry tab and are specific to a single telemetry setup. Additional Iridium settings are found on the Other Setup tab of LinkComm; those are global settings.

Iridium transmissions are delayed by a random time of up to 30 seconds. This delay is mean to prevent on-air collisions from multiple transmitters.

### 11.3.1 Iridium Global Settings

These settings are found on the Other Setup tab of LinkComm. Please read on for a list and description of each setting.

#### 11.3.1.1 Iridium Listening

If enabled, **Iridium Listening** will cause the station to keep the Iridium modem on all the time. This results in messages sent to the station being received near immediately. This reduces the data costs associated with connecting to the Iridium gateway in order to check messages. In this mode, the station will reset the modem once a day for reliability, resulting in at least one connection to the gateway daily.

The downside to enabling Listening is increased power draw.

#### 11.3.1.2 Iridium Msg Interval

Please note that even with Listening disabled, the station will still check for messages periodically. A message check happens with every transmission. If scheduled transmissions are disabled, message checking still happens every Msg Interval. The message checking may not be disabled without disabling the whole modem. Message checking will happen at least once a day. **Message checking happens even if recording is off.**

Message checking will NOT happen if the transmission interval is faster than *Msg Interval*. This is because **every transmission already includes a message check.**

If a unit is setup with a *Scheduled Interval* of 1 hour and a *Msg Interval* of 15 minutes:

- ▶ 00:15:00 - Message Check
- ▶ 00:30:00 - Message Check
- ▶ 00:45:00 - Message Check
- ▶ 01:00:00 - Transmission and Message Check- No additional message checking required
- ▶ 00:15:00 - Messages Check

With a *Scheduled Interval* of one hour and a *Msg Interval* of 24 hours, no additional message checking occurs:

- ▶ 23:00:00 - Transmission and Message Check - No additional message checking required
- ▶ 00:00:00 - Transmission and Message Check - No additional message checking required
- ▶ 01:00:00 - Transmission and Message Check - No additional message checking required

The message check serves several purposes:

- ▶ It prevents the customer from permanently severing the remote connection.
- ▶ It allows stations to go into lower power mode than if *Listening* were enabled.

Please note that message checking is not scheduled to occur at a specific time. Message checking is guaranteed to happen at least every Msg Interval. It is not scheduled to happen at the top of the hour or at any other time. If the interval is set to an hour, it means that it may take up to an hour for a message to be received. It does NOT mean that it will happen at the top of every hour.

#### 11.3.1.3 *Iridium Enable*

The **Iridium Enable** setting may be used to completely disable the Iridium modem. If disabled, the station will never power on the modem, and no Iridium features will be available. This setting is the equivalent of disconnecting the modem from the board. It may not be set remotely.

#### 11.3.1.4 *Iridium Tx Station Name*

This setting controls whether Iridium telemetry should include the station name in the header of the message. Please see [16.12.3 IRIDIUM TX STATION NAME](#) for more details.

## 11.4 Additional Telemetry Settings

### 11.4.1 Max Tx Time

This value dictates how long the system will keep trying to reach the server. If a connection is not made during this time, the system will give up on the transmission and mark it as failed.

This value should be less than the Scheduled Interval.

### 11.4.2 Retransmit

The retransmit setting controls whether or not the station will automatically attempt to retransmit failed transmissions. Please see section [13.4 RETRANSMISSIONS](#) for details.

### 11.4.3 Sensor Cutoff Offset and Skip First Missing

Some setups may result in sensor data not being available in time for transmissions. This is usually the result of a sensor taking a long time to respond. While this scenario is uncommon, there are several settings that may be used in order to prevent missing data in transmissions:

- ▶ Skip First Missing
- ▶ Sensor Cutoff Offset

When Skip First Missing is enabled (it is enabled by default), if the first reading that was slated for transmissions is missing, the system will skip that reading and go for the next one.

For example, a measurement is scheduled for 12:00, 12:15, 12:30, etc. A transmission is scheduled for 12:31. With that setup, the system is supposed to include the 12:30 measurement in the transmission. However, the system does not find that reading in the log. The system has two options at this point:

- ▶ Skip the 12:30 reading and use the 12:15 reading as the first one (Skip First Missing is On)
- ▶ Put a missing reading marker in the transmission (Skip First Missing is Off)

The most likely cause for a missing reading is the response time of the sensor. If the sensor takes several minutes to respond, the reading is likely to be missing. However, if the sensor takes a variable amount of time to respond, sometimes taking less than two minutes, and sometimes taking more, the system may



end up with inconsistent transmission data content. In that case, disable Skip First Missing, and increase the Sensor Cutoff Offset.

Sensor Cutoff Offset helps prevent missing data in a transmission by specifying how old the newest measurement in the transmission may be. The default value for the offset is zero.

Let us continue with the example above. With the Sensor Cutoff Offset at 00:01:00, the transmission scheduled for 12:31:00 will look for the first measurement to have been collected at 12:30:00. If the Sensor Cutoff were 00:05:00, then the system would not try to include any data collected after 12:26:00, which would cause the system to use the 12:15:00 reading as the first one.

#### 11.4.4 Append Options

The "Append Options" add information to the end of the transmitted data. Not all options are available for all transmission kinds. Not all transmission formats support all the append options.

- ▶ ASCII Column format does not allow any append options.
- ▶ All the other formats support all the append options.

Please see section [16 TRANSMISSION DATA FORMATS](#) for formatting details.

The options are listed below.

##### 11.4.4.1 *Use SHEF Codes for Options*

This setting is not an append option per se; it controls how the headers for the other append options. If selected, standard SHEF codes are used as the headers. All the examples below use SHEF codes.

##### 11.4.4.2 *Battery Voltage*

The battery reading measured prior to the transmission. Example: “:YB 12.50” would be formatted if the voltage were 12.5.

##### 11.4.4.3 *Station Name*

The station name option appends the customer entered Station Name setting. For Iridium telemetry, this setting also controls whether the station name is included in the transmission header.

If the station name were “Small Creek”, it would be formatted as “:YN Small Creek”

##### 11.4.4.4 *Tx time*

The time of the current transmission expressed as HHMMSS. “:YD 131015” is used for a time of 13:10:15.

##### 11.4.4.5 *Serial no*

This is the serial number of station. The SHEF format would be “:SN 00001” where 00001 is the station serial number.

#### 11.4.4.6 Tx Count

This option provides the count of good and bad transmissions. For a station that has made 19350 good and 2 bad transmissions, the SHEF format would be “:YG 19350 :YH 2”.

#### 11.4.4.7 Append Options Example

Here is an example of all the append options in a SHEF format using SEHF codes. The order of the values is battery, lat/long, forward power, reflected power, station name, temperature, time (HHMMSS), serial number, and transmission count:

```
:YB 11.99 :YN Small Creek :YD 172100 :SN 00001 :YG 19350 :YH 2
```

With SHEF codes disabled, the same append options look like so:

```
:BL 11.99 :NAME Small Creek :YD 172100 :SN 00001 :GOOD/BAD 19350/2
```

For append option details in other formats, please take a look at section [16 TRANSMISSION DATA FORMATS](#).

## 11.5 Telemetry Status

Telemetry status provides details for each type of transmission setup. The details can give valuable insights into how each type of telemetry is performing.

**Telemetry Status**

**TX1 Cell Scheduled**  
 Enabled  
 Next Tx time: 2018/07/30 19:00:30  
 Tx succeeded: 1 total, 1 today  
 Retx succeeded: 0 total, 0 today  
 Tx failed: 2 total, 2 today  
 Last Tx: succeeded at 2018/07/30 18:41:41

**TX2 Cell Alarm**  
 Enabled  
 Tx succeeded: 0 total, 0 today  
 Tx failed: 0 total, 0 today

**TX3 Cell Scheduled**  
 DISABLED  
 Tx succeeded: 0 total, 0 today

Refresh

Clear Retrieve new tele

Transmit Now

Show Tx Data

Radio Diags...

### 11.5.1 Refresh

The telemetry status does will not update automatically. The “refresh” control retrieves current information.

### 11.5.2 Clear Counts

This control clears the succeeded and failed counts. Sutron recommends clearing the counts during each field visit.

### 11.5.3 Transmit Now

**Transmit Now** causes the station to initiate a transmission on the selected setup (TX1, TX2, ...). This is useful for ensuring the station is able to connect to the server.

### 11.5.4 Show Tx Data

Show Tx Data is a great way to confirm that the station has been properly setup to transmit your intended data. The display shows the last transmission and what will be transmitted by the next transmission. Review the information carefully to make sure that you have the right number of readings marked for tx and the transmission fits in the specified window.

### 11.5.5 Radio Diags

This feature provides diagnostic information for the Cell and Iridium radios. Pressing it will bring up a Diagnostics window that shows the current status of the Iridium or Cell modem, along with signal strength information. The information will automatically upgrade and graph the signal strength over time.

Besides signal strength, information provided includes the time when the modem last connected to the network, contents of the last received message, phone number, IP address, and IMEI.

For Iridium modems, the Diagnostics window brings up the **Message Check** option. Pressing this button causes the system to immediately contact the Iridium gateway or the Cellphone network and ask for new incoming messages. The most recently received message since power on will be shown in the Diagnostics window.

For cell modems, the Diagnostics window offers the **Send SMS** option. It may be used to send a text message to any cell number provided. The text message will contain the station name and current time.

Data usage metrics are shown in the Diagnostics window. The system will track

- ▶ Number of bytes transmitted today
- ▶ Number of bytes received today
- ▶ Number of bytes transmitted lifetime
- ▶ Number of bytes received lifetime

Please note that these numbers are estimates. To get accurate data usage, especially over the cellular network, please contact the network provider.

If secure TLS protocols are used, the data usage estimates will not account for TLS overhead..

Clearing the status will clear the data usage tallies.

## 12 Other Setup

---

The Other Setup tab provides settings for Wi-Fi, Logging, Digital Output, and Modbus. The settings for each is described below.

### 12.1 Wi-Fi

The Wi-Fi section controls the operation of the Wi-Fi hotspot built into the station.

**Please note that this Wi-Fi hotspot is NOT connected to the internet.**

The purpose of the Wi-Fi hotspot is to allow someone who is on site to connect to the station with a mobile phone, a tablet, or a laptop wirelessly. This hotspot is not connected to the internet. It is a one on one connection between the station and the computer.

The range of the Wi-Fi is circumstantial. Direct line of sight may provide access within 100 feet.

For instructions on how to connect to the station via Wi-Fi, please see [6.3.3 CONNECTING VIA WI-FI](#).

To ensure security, please enable Wi-Fi password protection. The Wi-Fi security is distinct from XLink's password protection. Even if Wi-Fi security is not enabled, XLink is still protected by its password as per [8.2 PASSWORD PROTECTION](#).

The station only turns on the Wi-Fi hotspot at certain times. There are two settings that control when it is turned on:

- ▶ *Wifi Enable*: If this setting is off, the station will never turn Wi-Fi **automatically**. It will only turn on when the front button is pressed or when the WIFI ON command is issued.
- ▶ **Please note that pressing the wakeup button will turn on the Wi-Fi hotspot even if Wifi Enable is off.**
- ▶ *Wifi Always On*: if this setting is on, the Wi-Fi spot provided by the station will always be turned on. Turning this setting on will result in increased power consumption, but it will make the station always available.
- ▶ *Wifi Security enable*: This setting enables WPA2-AES security. A passphrase must be entered to allow Wi-Fi access.

The table below describes when the Wi-Fi hotspot is on.

Wifi Enable	Wifi Always On	Result
OFF	-	The Wi-Fi hotspot is off. It is only turned on if the wakeup button is pressed. It stays on for one hour after the button press.
ON	ON	The Wi-Fi hotspot is always on.
ON	OFF	The Wi-Fi hotspot is turned on for 10 minutes: <ul style="list-style-type: none"> <li>• at boot up</li> <li>• when the station is connected to, whether via USB, over the modem, or over Wi-Fi</li> <li>• after an SMS is received</li> <li>• after a LISTEN command.</li> </ul> The Wi-Fi hotspot turns on for one hour when: <ul style="list-style-type: none"> <li>• The wakeup button is pressed</li> <li>• The station goes into alarm</li> </ul>

## 12.2 Log Daily Values

The station can log diagnostic information at 23:59:59 each day. That information consists of current battery voltage, current temperature, and telemetry accounting, such as the number of transmissions made and the number of bytes transmitted.

To prevent this data from being logged, disable the *Log Daily Values* setting. Even if logged, the data will only be downloaded if the *Include Events* option is selected during the download.

## 12.3 Digital Output

XLink includes one digital output labeled DOUT 1.

The digital output is DOUT#1 (Output1). The digital output is an open collector type output. This provides direct interface to many products. The open collector output sinks 100mA (rated at >400mA) on a continuous basis.

It is expected that a pull-up resistor will be connected to the Prot+12V or other supply. The value of the pull-up may be determined by the impedance of the connected load. A10 kOhm resistor may be used as a default.

**With a pull-up resistor connected**

- ▶ When the output is **turned on**, the output sinks current from all attached devices.

- ▶ When the output is **turned off**, the output is pulled up to the supplying voltage.

The digital output may be activated via several means.

- ▶ Manually via command line. A command may be sent via LinkComm over USB, via an SMS, via an Iridium message, or via any other means of connecting to the station.
- ▶ Alarms: any sensor going into alarm may trigger the digital output.
- ▶ Equations: any measurement setup with the Output function in an equation may pulse the digital output for a specified amount of time. Please see section [10.4.4 EQUATION](#) for details.

The system can automatically activate the output based on alarms. The setting *Output1 Control* dictates whether alarm activity triggers the output.

The setting *Output1 Control* can be set to:

- ▶ *Manual*: The system will do nothing with the digital output when it goes into and out of alarms.
- ▶ *Alarm In*: The system turns on digital output when any measurement goes into alarm. The system does nothing with the output when it goes out of alarm.
- ▶ *Alarm In And Out*: The system turns on digital output when any measurement goes into alarm and it turns off digital output when any measurement goes out of alarm.

**LinkComm** has the Digital Output settings on the Other Setup dialog.

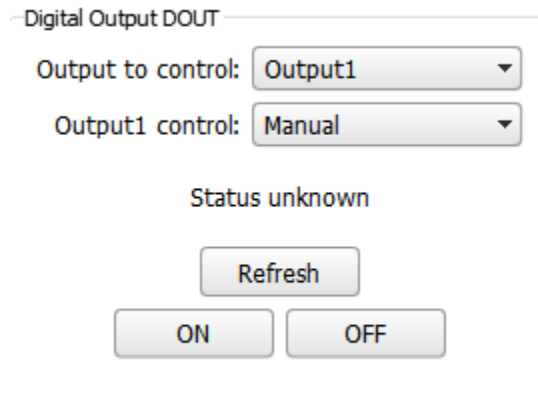

The controls in the **Digital Output DOUT** section can be used to view the status of the digital output, and to control its state. Press the **Refresh** button to display the current state of DOUT. The current state is displayed just above the button. Press the **ON** button to turn DOUT on. Press the **OFF** button to turn DOUT off.

**Command line** access to output 1:

- ▶ OUTPUT1 tells whether the output is currently on. Possible replies:
  - ▲ Output1 is NOT active
  - ▲ Output1 is ACTIVE
- ▶ OUTPUT1 ON turns on the output
- ▶ OUTPUT1 OFF turns off the output



**If the digital output is turned off via command line while the system is in alarm, the system will not turn it back on until it goes out of alarm and later back into alarm.**



**A measurement setup for a *ROC Alarm* and an *Alarm ROC Interval* set to *Since Last Tx* does not have a going out of alarm state. Those alarms will never turn off the digital output.**

## 12.4 Cutoff

The system provides several cutoff settings. These settings are used to prevent the system from operating when the supply voltage or the temperature is outside of the allowed range.

These settings may only be changed via command line; LinkComm does not support them.

### 12.4.1 Battery Low

The Cutoff System Low and Cutoff Tx Low settings indicate a minimum voltage required for the system to operate. If the supply voltage goes below the cutoff, the system will go into battery low mode. The system will not operate normally when in battery low mode.

When the system is below Cutoff System Low:

- ▶ No measurements are made.
- ▶ Cell and Iridium modems are shut off.
- ▶ Wi-Fi is shut off.
- ▶ All output voltages are shut off:
  - ▲ VREF
  - ▲ +SW POWER
  - ▲ SDI-12 POWER
  - ▲ PROT +12V

When the system is below Cutoff Tx Low:

- ▶ No transmissions will be made.

The following systems are still operational when battery is low:

- ▶ USB micro port may be used to talk to LinkComm.
- ▶ RS-232 port is functional.
- ▶ USB thumb drive port may be used.
- ▶ Tipping bucket inputs are still counted when in battery low mode.

Once in battery low mode, the supply needs to exceed the cutoff voltage plus the deadband before it will return normal operation. By default, that value is 10V. Please see the Cutoff Deadband setting below.

#### 12.4.2 Cutoff System High and Cutoff System Low

The unit will automatically disable measurements if the voltage falls outside the Cutoff System High and Cutoff System Low limits. Measurements will recommence with the voltages return within range. The default operating range is 9V to 20V.

#### 12.4.3 Cutoff Tx High and Cutoff Tx Low

The unit will automatically disable transmissions if the voltage falls outside of Cutoff Tx High and Cutoff Tx Low limits. Transmissions will recommence with the voltages return within range. The default operating range is 9V to 20V.

Cutoff Tx Low should be equal to or higher than Cutoff System Low.

#### 12.4.4 Cutoff Deadband

After the system has gone below a cutoff low voltage level, it will not revert to normal operation until the supply voltage exceeds the cutoff low plus the deadband.

For example, if the Cutoff System Low is at the default 9.0V and Cutoff Deadband is at the default 1.0V, the system will enter battery low mode when the supply dips below 9.0V. Once the supply provides 10.0V or more, the system will restore normal operation.

This setting was added in version 8.24.

#### 12.4.5 Cutoff Temp Tx High and Cutoff Temp Tx Low

The unit will automatically disable transmissions if the temperature falls outside user specified limits. Transmissions will recommence with the temperatures return within range. The default range is -45C to +80C.

Below is a list of all the cutoff captured from command line usage:



```
Cutoff System High = 20.00 V, Range (14.00, 20.00)
Cutoff System Low = 9.00 V, Range (9.00, 13.00)
Cutoff Tx High = 20.00 V, Range (14.00, 20.00)
Cutoff Tx Low = 9.00 V, Range (9.00, 13.00)
Cutoff Temp Tx High = 85.0 C, Range (40.0, 100.0)
Cutoff Temp Tx Low = -45.0 C, Range (-80.0, -20.0)
Cutoff Deadband = 1.00 V, Range (0.00, 5.00), Default = 1.00
```

## 12.5 Iridium

Please see the [11.3 IRIDIUM SETUP](#) section for a description of these settings.

## 12.6 Cell

Please see section [11.2.3 CELL GLOBAL SETTINGS](#) for information on these fields.

## 12.7 Time

### 12.7.1 Local Time Offset

Normally, stations will use UTC time to provide a standard time reference across stations that are in multiple time zones.

If you would prefer to use local time, enter the time difference between local time and UTC in this field.

Note that daylight savings time is not considered.

### 12.7.2 Cell Time Sync Enable

Please see section [11.2.3.8 CELL TIME SYNC ENABLE](#).

## 12.8 Log Download Format

The settings in this section define the format of data downloaded from the station, whether the download occurs in LinkComm, or to USB thumb-drive.

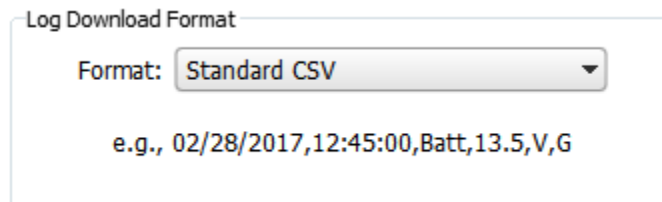

The **Format** setting may be “Standard CSV”, “Legacy CSV”, or “Custom”.

### 12.8.1 “Standard CSV” Log Download Format

The “Standard CSV” format follows the export formatting conventions you will find in most Sutron data loggers. The format of the data is as follows: date,time,label,value,units,quality. For example:

```
02/28/2017,12:45:00,Batt,13.5,V,G
```

### 12.8.2 “Legacy CSV” Log Download Format

The “Legacy CSV” format follows the export formatting conventions you would find in previous generations of Sutron site controllers. The format of the data is as follows: label,date,time,value,quality. For example:

```
Batt,02/28/2017,12:45:00,13.5,G
```

### 12.8.3 “Custom” Log Download Format

The “Custom” log download format allows you to specify a custom format for not only the measurement values, but also for the header and descriptor portions of the output file. When **Format** is set to “Custom”, three setup properties become visible.

Log Download Format

Format: Custom

Header format: ...

STATION, VERSION\r\n<STATION>, <VERSION>\r\nLABEL, TYPE, SLOPE, OFFSET, EQUATION\r\n

Descriptor format: ...

<LABEL>,<TYPE>,<SLOPE>,<OFFSET>,<EQUATION>\r\n

Measurement format: ...

MM/DD/YYYY,HH:MM:SS,<NAME>,<VALUE>,<UNITS>,<Q>\r\n

Note: LinkComm is unable to graph custom-formatted data

The three setup properties used to define the format of downloaded data files are:

- ▶ Log Header Format
- ▶ Log Descriptor Format
- ▶ Log Measurement Format

The format strings you'll use in each of these setup properties consist of VARIABLES, ESCAPE SEQUENCES, and FIELDS. Any text that isn't recognized as a VARIABLE, ESCAPE SEQUENCE, or FIELD, appears as-is in the final output.

VARIABLE	Replaced with dynamic data from the system. Always upper-case and typically wrapped in <> characters (date and time variables are not wrapped in <> characters).
ESCAPE SEQUENCE	Character preceded by "\" character, e.g., "\r\n", for inserting new-lines, tabs, etc.
FIELD	Replaced with descriptive text from the system. Always upper case.

### 12.8.3.1 Log Header Format

The Log Header Format entry defines the header that appears at the top of the file. Its maximum length is 511 bytes. The entry may be blank. The following example defines the standard header (when selected for inclusion in the download):

```
STATION,VERSION\r\n<STATION>,<VERSION>\r\nLABEL,TYPE,SLOPE,OFFSET,EQUATION\r\n
```

Variables that may be used when defining the Log Header Format entry:

- ▶ <SERIALMICRO>, micro board serial number, e.g., "1242671"
- ▶ <SERIALPRODUCT>, product serial number, e.g., "32XY812"
- ▶ <SERIALTX>, transmitter serial number, e.g., "0023354"
- ▶ <STATION>, station name, e.g., "RedRiver"
- ▶ <STARTTIME>, directive to use start time of log download when formatting a date-time for use in the header. The directive itself is not replaced by text, only date-time variables following the directive.
- ▶ <STOPTIME>, directive to use stop time of log download when formatting a date-time for use in the header. The directive itself is not replaced by text, only date-time variables following the directive.
- ▶ <VERSION>, firmware version information, e.g., "Sutron XLink..."

### 12.8.3.2 Log Descriptor Format

The Log Descriptor Format entry defines measurement settings, and appears after the header, if any. Its maximum length is 127 bytes. The entry may be blank. The following example defines the standard descriptor (when selected for inclusion in the download):

```
<LABEL>,<TYPE>,<SLOPE>,<OFFSET>,<EQUATION>\r\n
```

Variables that may be used when defining the Log Descriptor Format entry:

- ▶ <EQUATION>, equation of a measurement, e.g., "X+1"
- ▶ <LABEL>, label of a measurement, e.g., "Batt"

- ▶ <OFFSET>, offset of a measurement, e.g., "0.0"
- ▶ <SLOPE>, slope of a measurement, e.g., "1.0"
- ▶ <TYPE>, type of a measurement, e.g., "SDI-12"

### 12.8.3.3 Log Measurement Format

The Log Measurement Format entry follows the descriptor (if any), and defines the format of each measured value. The following example defines the standard measurement format:

```
MM/DD/YYYY, HH:MM:SS, <NAME>, <VALUE>, <UNITS>, <Q>\r\n
```

Variables that may be used when defining the Log Measurement Format entry:

- ▶ <NAME>, name (label) of a reading, e.g., "Batt"
- ▶ <Q>, quality of a reading (short), e.g., "G"
- ▶ <QUALITY>, quality of a reading (long), e.g., "Good"
- ▶ <UNITS>, units of a reading, e.g., "ft"
- ▶ <STATION>, station name, e.g., "RedRiver"

### 12.8.3.4 Date and Time Variables

The following examples illustrate how to specify date and time variables in format strings:

- ▶ MM, 2-digit month, e.g., "12"
- ▶ DD, 2-digit day, e.g., "01"
- ▶ YY, 2-digit year, e.g., "16"
- ▶ YYYY, 4-digit year, e.g., "2016"
- ▶ HH, 2-digit hour, e.g., "12"
- ▶ MM, 2-digit minutes, e.g., "03"
- ▶ SS, 2-digit seconds, e.g., "22"

Note, for measured data, date-time comes from the time of the data. For header and descriptor, date-time is current time, unless <STARTTIME> or <STOPTIME> has been specified (see below). Also note, context determines whether the formatter uses minutes or months for "MM".

### 12.8.3.5 Escape Sequences

Backslash ("\") is used to insert special characters, or to ignore formatting:

- ▶ \r inserts a carriage return
- ▶ \n inserts a line feed
- ▶ \r\n inserts standard line ending for files on Windows
- ▶ \t inserts a tab (use CTRL-TAB key combination in LinkComm)
- ▶ \\ inserts a single backslash
- ▶ A backslash preceding a field name means insert the literal field name, e.g., "\STATION" results in "STATION".

### 12.8.3.6 Fields

Fields are replaced with standard descriptive text from the system, which may change between firmware versions. Fields are always upper case.

- ▶ LABEL, e.g., "Label"

- ▶ OFFSET, e.g., "Offset"
- ▶ STATION, e.g., "Station Name"
- ▶ SLOPE, e.g., "Slope"
- ▶ SERIALPRODUCT, e.g., "SerialNo Product"
- ▶ SERIALMICRO, e.g., "SerialNo Micro"
- ▶ SERIALTX, e.g., "SerialNo Tx"
- ▶ TYPE, e.g., "Meas Type"
- ▶ VERSION, e.g., "model and version"

#### 12.8.3.7 Fixed Width Output

Vertical bar characters are used to fix column width and alignment. For example:

- ▶ |11:<VALUE>| : Left aligned, width 11
- ▶ |<VALUE>:11| : Right aligned, width 11
- ▶ |11:<VALUE>:| : Centered, width 11

#### 12.8.3.8 Optional Output

Brackets are used to signal output that should be populated only if at least one of the contained variables is non-blank, or in the case of the quality field, bad quality. The following examples makes both units and quality optional in measurement output:

```
MM/DD/YYYY,HH:MM:SS,<NAME>,<VALUE>[,<UNITS>,<Q>] \r\n
```

Optional fields may be nested.

## 12.9 Modbus

Please refer to section [19 MODBUS](#) for details.

## 12.10 General Purpose Variables

A set of general purpose variables allows the user to store information in the station's setup.

- ▶ Each set consists of a label and a value.
- ▶ The label is an ASCII string up to 19 bytes long.
- ▶ The value is IEEE32 bit floating point number.
- ▶ There are 32 sets, allowing one to store 32 labels and 32 values.

The variables' original purpose is to allow a means of storing configuration data for Python scripts. However, the variables may be used in any way the user sees fit.

- ▶ The system will not normally read or write the variables.
- ▶ These variables are stored in permanent memory. They are not lost on bootup.
- ▶ Setting the system to defaults will reset the values of the variables.
- ▶ LinkComm provides a convenient way of reading and writing these variables via the Other Setup tab.

- ▶ The variables are stored in EEPROM which has an endurance of 100,000 to 1,000,000 cycles. Do not write the variables too often lest the EEPROM wear out.
- ▶ General Purpose Variable support was added with version 8.26

Please take a look at the command line capture below:

```
GP1 Label = Variable1, max length 19, Default = Variable1
GP1 Value = -1.000000, Range (-1000000.000000, 1000000.000000), Default = -
1.000000

GP2 Label = Variable2, max length 19, Default = Variable2
GP2 Value = -1.000000, Range (-1000000.000000, 1000000.000000), Default = -
1.000000
```

# 13 Telemetry

## 13.1 Iridium Telemetry

XLink may be equipped with an optional Iridium module. The module is plug and play and fits into one of the option port. When so equipped, XLink is capable of sending transmissions and receiving messages using the Iridium satellite network.

- ▶ Iridium may be used to provide reliable two-way communications anywhere on the planet.

Please see section [11.3 IRIDIUM SETUP](#) for details on setting up Iridium.

Iridium satellite coverage is available everywhere. The diagram below shows how the signal travels through the Iridium Gateway to an email address, etc.

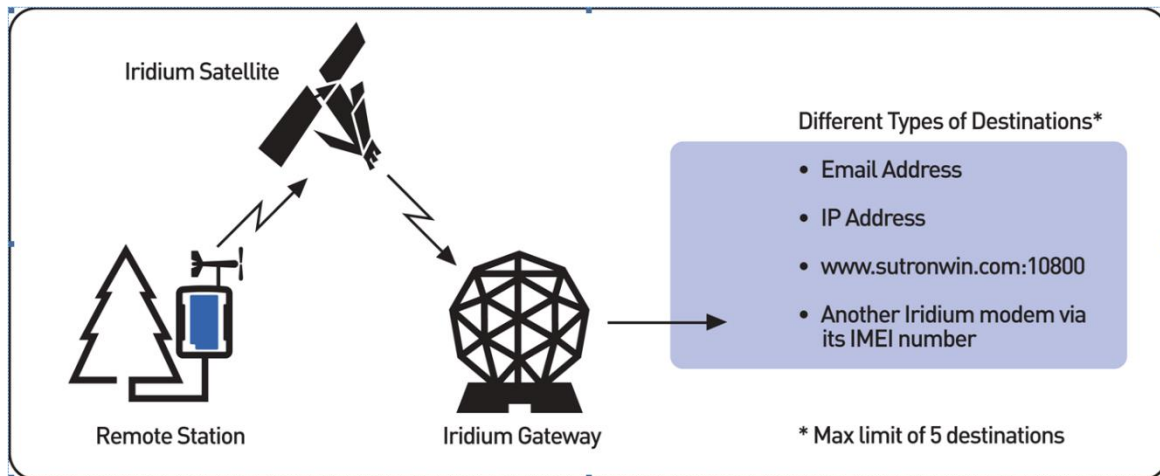

### 13.1.1 Iridium Antenna Placement

The Iridium antenna must be placed where it has a clear view of the sky.

Iridium satellites are not geostationary. This means that coverage of a certain area may vary from one minute to the next. To be considered reliable, the station must have a strong signal for 10 to 20 minutes.

The antenna-aiming feature can aid in correct station setup. It will show the current signal strength. Signal strength ranges from 0 (no signal) to 5 (excellent signal).

- ▶ A signal strength of 4 or higher indicates a strong signal.

- ▶ The station needs to consistently report a strong signal for 10 to 20 minutes to indicate good antenna placement.
- ▶ If signal strength is varying, the antenna's view of the sky is obstructed.
- ▶ In theory, any signal strength above 0 means that a transmission can be made. However, to ensure reliable and consistent data transmissions, reposition the antenna to get better signal.
- ▶ A signal strength of 0 indicates that there is no signal at all; the station will not be able to make any Iridium transmissions.



**When installing the station, make sure the station consistently reports a signal strength of 4 or higher for at least 10 minutes.**

### 13.1.2 Short Burst Data

XLink uses the Iridium Short Burst Data (SBD) capability to send transmissions and receive messages.

XLink uses messages to communicate via Iridium. Messages may be sent to the station via Iridium, and the station may send messages in return.

Each message may contain up to 340 bytes.

### 13.1.3 Transmission Data Content

Each measurement is independently setup with the data content for each transmission. Please see section [10.8 TRANSMISSION DATA CONTENT SETTINGS](#) for details.

A single message can only hold a limited amount of data. If there is more data than can fit, multiple transmissions will have to be sent. In order to receive the freshest data, the transmission interval should be set such that only one message is sent at one time. Given the choice of getting one transmission every 15 minutes or getting two back-to-back transmissions every 30 minutes, opt for the 15-minute data. The price is the same, but the data is refreshed more frequently.

The station will send up to five separate SBD messages for each transmission, providing a maximum capacity of 1655 bytes worth of data. If that is not enough data, increase the transmission interval or setup two different Iridium transmissions.

#### 13.1.3.1 Iridium Setup

Please see section [11.3 IRIDIUM SETUP](#) for details on setting up Iridium.

#### 13.1.3.2 Iridium Message Checking

When an Iridium Scheduled transmission is made, the system is notified of any incoming messages. Checking for messages in this fashion does not incur any additional data usage costs.

If your station is set up to make transmissions every 30 minutes, that means that it will take up to 30 minutes for the station to receive any messages sent to it. If that is too long, you may consider turning on *Listening*. Please see section [11.3 IRIDIUM SETUP](#) for more on Listening and Message Checking.



### 13.1.4 Sending Messages to the Station via Iridium

Stations with Iridium modems can have messages sent to it via emails that get routed through the Iridium system.

If *Listening* is enabled, the station receives messages immediately. In this mode, the modem is always on, and the station consumes more power.

If *Listening* is disabled, the system checks for messages when it makes a transmission. If the station is set up with a *Tx Interval* of 15 minutes, it may take up to 15 minutes for the station to receive the message sent to it. With *Listening* disabled, the station turns off the modem between transmissions to save power.

Additionally, the station can be setup to do periodic message checking. No matter how it is setup, the station will do a message check every 24 hours. Please see section [11.3 IRIDIUM SETUP](#) for more on Listening and Message Checking.

When the station is turned on, it keeps the Iridium modem on for ten minutes. During that time, it will receive messages immediately. When it does receive a message, the station will keep the modem turned on for ten additional minutes to facilitate additional message conversations.

Messages are treated like command line input with a few differences. Some commands cannot be executed via a message (e.g. log download). Other commands may have a differently formatted output (in order to reduce message size).



**Do not forget to precede the commands with an exclamation point if you want the station to reply.**

To check the status of your station, send it the message

```
!STATUS
```

Password protected stations will need login information to be the very first thing in a message:

```
!LOGIN=XXX; STATUS
```

The system remembers the last message received since boot up. To see it, press the Radio Diags button on LinkComm's Telemetry tab or issue the STATUS TX command.

Email is used to send messages to the station via Iridium.

- ▶ The email message must be sent to Data@SBD.Iridium.com

- ▶ The email's subject must be the IMEI of the Iridium modem. The IMEI may be seen by pressing the Radio Diags window of LinkComm's Telemetry tab. Each transmission made by the station over Iridium will be stamped with its unique IMEI.
- ▶ The email needs an attachment containing the command(s) to be sent. The attachment is a simple text file, and it must have the .sbd extension. Example file names: Status.sbd, MultiCmd.sbd
- ▶ The body of the email should be blank. Do not put commands for the station into the body of the email.
- ▶ The attachment may not be larger than 270 bytes.
- ▶ Each command may be replied with no more than two messages, for a total of 680 bytes.
- ▶ The first byte of this file must be an ! in order for the station to send a reply. E.g. !STATUS
- ▶ Multiple commands may be sent in a single message. Commands can be separated with a new line or a semicolon ; E.g. !LAST; !STATUS;

## 13.2 Cellular Telemetry

The station may be equipped with a cellular modem. The cell modem provides the station with internet connectivity and the ability to send and receive SMS (text messages).

Depending on the modem and the network service, the station can

- ▶ Deliver sensor data on a regular schedule.
- ▶ Deliver timely alarm notifications.
- ▶ Send data via SMS (text messages) and via TCP/IP (internet).
- ▶ Allow remote LinkComm connections over the internet.
- ▶ Receive command line commands via text messages; respond to said commands.

When the modem is online, LinkComm may be used to remotely connect to the station. Such connections are very similar to being directly connected to the station via USB cable: one may download the log, change the setup, and upgrade firmware.

A cell modem provides

- ▶ Two-way communications
- ▶ High bandwidth remote station access
- ▶ Reliable and timely alarm notifications
- ▶ Redundant telemetry
- ▶ [SMS NOTIFICATIONS](#) as per section [13.2.5](#)

Please note that cell modem operation requires network coverage and network service. Network service generally requires a service contract that involves monthly and/or per usage charges.

Please see section [11.2 CELL SETUP](#) for settings that govern cell operation.

### 13.2.1 Antenna Placement

A station with a cell modem must be installed in places with usable cell phone coverage. The antenna aiming feature can help determine the quality of signal at installation time.

### 13.2.2 Two-Way Communication

When the cell modem is online, you may use LinkComm to download the log, change the setup, check the status, upgrade the firmware, and do almost any other operation that can be done over USB.

### 13.2.3 Scheduled Transmissions

The station may be set up with a time and interval dictating how often to deliver data. At designated times, the station will power up the modem, establish a connection to the internet, get in touch with the server and deliver the data. To use scheduled transmissions, the station needs to be set up with the internet address of a primary server and, optionally, a backup server so that it knows where to deliver the data. The backup server is contacted only if the primary server cannot be reached.

If internet service is not an option, the station may be setup to transmit data via SMS (text messages). Data can be delivered to up to three cell phone numbers for each telemetry setup.

### 13.2.4 Listening

An station can be set up to always be listening, which means that it will act as a server, accepting TCP/IP incoming connections. Sutron's AutoPoll PC software can periodically reach out to a listening station and download sensor data from the station. In the listening mode, the station will keep the modem on at all times, resulting in higher power consumption.

Please see section [11.3 IRIDIUM SETUP](#) for more on listening and accepting incoming connections.

The transmission status (use LinkComm's Telemetry tab or issue STATUS TX command) indicates the IP address assigned to the station by the service provider. The *Listen Port* setting determines which port station keeps open.

### 13.2.5 SMS Notifications

If *Cell Notifications Enable* is enabled by the customer, the station reports certain events via SMS to a list of user-entered phone numbers (*SMS Notify Phone A* and *SMS Notify Phone B*). The purpose of this feature is to notify the customer that a major event has transpired at the station.



**SMS notifications are meant to be sent to a customer's cell phone. They are meant to be immediately read by a person (rather than a computer, like Hydromet Cloud). SMS notifications are the way for a customer to receive notices about station issues on his cell phone.**

The following events may cause notifications:

- Alarms: Details such as which measurement went into alarm and the measurement reading

- Station Rebooted: The time the station rebooted is sent along with the kind of reboot (power on, watchdog reset, upgrade, etc.).
- Recording on/off: When recording is started or stopped, a SMS message will be sent
- Transmission failure
- SDI-12 sensor failure
- Measurement failure
- Any error

The following settings control the events that cause notifications:

- ▶ Notify On Bootup
- ▶ Notify On Recording
- ▶ Notify On Tx Fail
- ▶ Notify On Alarms
- ▶ Notify On SDI12 failure
- ▶ Notify On Measurement error
- ▶ Notify On Any error

Please note that there is some overlap between the error notifications.

Only one error notification is sent at a time, and only one error notification is sent per day. This means that additional errors may be not be reported.

The cell modem will be kept on for 15 minutes after a notification is issued, allowing the customer to send a follow up SMS to get more information. For example, replying to a notification SMS with the text “!ERROR” will cause the station to reply with an SMS containing the list of errors.

All notifications have the same format. Up to two SMS are sent per notification; please note that not all the data may fit. Here are some examples:

- ▶ The station name is on the first line of the message.
- ▶ The current station time is on the second line.
- ▶ The next line contains the event that caused the notification, e.g., “Alarm In”, “Error”.
- ▶ If appropriate, error details are on the next line.
- ▶ The most recent measurements are listed next, along with the alarm state for each. E.g. “TEMP 25.5 C”
- ▶ At the end of the SMS are the number of transmissions made today, e.g. “TX3 today: good 31, bad 3”

Below is an example of a bootup notification. There is no measurement data because the system had no time to make a reading.

```
Sutron XLink 500 testbase
2017/11/07 15:25:54
Reset Soft
TX3 today: good 0, bad 0
```

Here is an alarm notification:

```
Sutron XLink 500 testbase
2017/11/07 17:05:07
Into Alarm
BATT 16.215 V Into Alarm
TEMP 24.50 C
MINO 1025
Sense4 -99999.00
TX3 today: good 3, bad 0
```

### 13.2.6 File Transmissions

Files created by Python scripts may be transmitted to an FTP server using the cellular modem. An SD card is required for this operation. *This feature was added in version 8.33.*

- ▶ File transmissions may be used to send data that is not collected via Measurements.
- ▶ Python scripts are the only way to create files.
- ▶ Files must be saved on the SD card, in a specific folder
  - Telemetry 1 uses SD/TX1, Telemetry 2 uses SD/TX2, etc.

#### 13.2.6.1 Procedure

##### Transmission setup

- ▶ Set [DATA SOURCE](#) to File as per section [11.2.1](#).
- ▶ Set Tx Mode to FTP as per section [11.2.2](#)
- ▶ Optionally modify Max Files Per Tx and File Expiry Period settings.
  - ▶ Please read below and see the relevant settings in section [11.2.1](#) to understand the settings.

##### Python file creation

- ▶ A Python script is required to create a file.
  - ▶ Please see section [20 SCRIPTS](#) for instructions on working with scripts.
- ▶ Python scripts must save the files in the transmission folder:
  - ▶ Use SD/TX1 for files to be sent by Telemetry 1, SD/TX2 for Telemetry 2, etc.
- ▶ Multiple scripts may write to the same folder.
- ▶ Multiple files may be placed in the same folder.
- ▶ Files must be ready by transmission start time.

#### At transmission time

- ▶ Files are first checked for expiry:
  - ▶ The timestamp of the file is compared to the transmission time. If the difference in time is greater than the File Expiry Period setting, the file is considered expired.
  - ▶ All expired files are deleted.
- ▶ Any remaining files in the transmission folder are transmitted
  - ▶ The newest file is transmitted first.
  - ▶ The number of transmitted files may be limited using the Max Files Per Tx setting.
  - ▶ If Max Files Per Tx is set to 1, only one file will ever be transmitted at each transmission time. If a file transmission should fail, that file will never be transmitted.
  - ▶ Otherwise, files that were not transmitted on time may be transmitted in subsequent transmissions.
  - ▶ If there are no files in the folder, the transmission will fail with an error.
- ▶ Transmitted files are deleted:
  - ▶ Once a file is successfully delivered to the FTP server, the file is deleted from the transmission folder.

In order to both transmit a file and keep the file on the SD card, have the Python script save two copies of the file. One copy should go into the transmission folder, the other into any other folder.

#### **Please note file deletions:**

- ▶ Successfully transmitted files are deleted!
- ▶ Old, expired files are deleted!

#### 13.2.6.2 *Example Scenarios*

The scenarios below illustrate how to use the Max Files Per Tx and File Expiry Period settings.

The system creates and transmits one file every two minutes. Only the most recent file is relevant.

- ▶ Set Max Files Per Tx to 1. This ensures only the most recent file is transmitted.
- ▶ Set File Expiry Period to 4 minutes. This ensures unwanted files do not accumulate on the SD card.

The system transmits one file every 4 hours. All files are important.

- ▶ Leave Max Files Per Tx at the default 16. This ensures that, if a transmission fails, subsequent transmissions transmit older files.
- ▶ Leave File Expiry Period at the default of 7 days. This ensures that files are kept until transmitted while at the same time ensuring that a station does not transmit old files after a prolonged shutdown.

## 13.3 Missing Data Retrieval

In the case of transmission failures, XLink offers several ways of retrieving the data from the missing transmissions.

### 13.3.1 On-Site Data Retrieval

To retrieve missing data when on-site, download the station's log. Either use a USB thumb drive or connect to the station with LinkComm in order to download the log.

### 13.3.2 Remote Data Retrieval

The optional Iridium and Cell modules provide a means of remotely accessing the station.

#### 13.3.2.1 TCP/IP Connection

If the station has a cell modem module, a TCP/IP connection may be established using LinkComm. Once the session is established, download the station's log the same way you would as if you were on-site.

#### 13.3.2.2 Messaging

If the station is equipped with the Iridium or the Cell module, it is possible to send the station a message requesting the missing data. Please see Repeat Tx Data below.

#### 13.3.2.3 Repeat Tx Data

Repeat tx data requests may be used to get missing data from a station. These requests may be issued when directly connected to the station (via USB, RS-232, Wi-Fi) and they may be issued remotely (e.g., via Iridium). The station will reply to these requests by providing transmission data that would have been transmitted at some point in the past.

In order to have the station repeat a transmission, apply the REPEAT option to the TXFORM command along with a date/time of the missing transmission. The station will reply immediately with the data.

- ▶ Syntax: TXx TXFORM REPEAT YYYY/MM/DD HH:MM:SS
  - ▲ TXx may be any Tx (e.g., TX2, TX3)
  - ▲ YYYY/MM/DD HH:MM:SS is the date/time of the Tx data that needs to be provided

Here is a capture of the command line session:

```
!TX1 TXFORM RETX 2016/6/20 23:00:30
:BATT 0 #10 10.887 11.032 11.232 10.971 11.316 11.111 :TEMP 0 #10 28.25
28.25 28.00 28.25 27.75 27.50
```

Here is a usage scenario:

- ▶ Customer is missing a transmission that should have happened at 2016/6/20 23:00:30.
- ▶ Customer sends an Iridium message with the syntax
- ▶ !TX1 TXFORM REPEAT 2016/6/20 23:00:30
- ▶ The station replies via an Iridium message with

- ▶ 6:BATT 0 #10 10.887 11.032 11.232 10.971 11.316 11.111 :TEMP 0 #10 28.25 28.25 28.00 28.25 27.75 27.50

Please note that the station simply replies to the command with the data. In this example, the station was asked for data via Iridium, so it replied via Iridium. If it had been asked via RS-232, it would have replied via RS-232.

A note about timestamps in the repeat Tx data: The timestamps are the same as if the Tx were made at the provided time, rather than indicating the true age of the data. This means that the sensor data in the Tx is exactly the same as that of the Tx made in real time (which is 2016/6/20 23:00:30 in the example above). It is the caller's responsibility to handle the timestamps.

Why not have the timestamps indicate the true age of the data:

- ▶ Unlike re-transmissions which are initiated by the logger, these repeat Tx data transmissions are initiated by someone who knows the timestamps of the missing data.
- ▶ Some systems will find it easier to integrate data that is in an unmodified format.
- ▶ Most data formats (including SHEF and Pseudobinary B) do not support timestamps that indicate very old data.
- ▶ Note that append data is NOT provided in a repeat transmission!

The capture below illustrates the difference that the REPEAT option has on the TXFORM command. Note that no date was issued with the REPEAT command, meaning it uses the current time as the time of Tx. Note the lack of append data.

```
>TX1 TXFORM
Tx data would look like this

:BATT 2 #10 11.347 11.423 11.385 11.377 M M :TEMP 2 #10 26.00 25.25 25.75
26.00 M M :BL -1.00 :PWR -1.0/-1.0

Current message is 108 bytes (00:00:04 seconds) out of 2218 bytes (00:01:00
seconds)
Available space is 2110 bytes
In that message, sensor data is 83 bytes

Worst case SENSOR data (excluding append) is 138 bytes (00:00:05 seconds)
Worst case available space is 2080 bytes
2 meas are active; 2 are marked for tx

>TX1 TXFORM REPEAT
:BATT 2 #10 11.347 11.423 11.385 11.377 M M :TEMP 2 #10 26.00 25.25 25.75
26.00 M M
```

### 13.3.3 Automatic Missing Data Retrieval

Cell and Iridium transmissions may be automatically retired. Please see Retransmissions below.



## 13.4 Retransmissions

XLink is able to make retransmissions (ReTx). Retransmissions are retries of failed scheduled transmissions. The goal of retransmissions is to automatically retransmit data that was in the failed transmissions.

### 13.4.1 How Retransmissions Work

When a scheduled transmission fails, the system notes the time of the failure. Once a future scheduled transmission succeeds, the system will proceed to re-transmit the data from the missing transmissions.

Here is an example of retransmissions in action:

- 12:00 Scheduled transmission succeeds. All is well.
- 12:30 Scheduled transmission fails due to lack of network.
- 13:00 Another scheduled transmission fails.
- 13:30 Scheduled transmission succeeds. Network is back up.
- 13:31 Retransmission with data as if it were 12:30 completes.
- 13:32 Retransmission with data as if it were 13:00 completes. All previously missing data has been transmitted.
- 14: 00 Scheduled transmission completes. Back to business as usual.

### 13.4.2 Retransmission Setup

For retransmissions to take place, the setting *Retransmit* must be enabled. It is enabled by default. A proper *Tx Format* is also needed to ensure that the data in the transmission is timestamped. Pseudobinary B is the only unacceptable format. Use Pseudobinary D instead of Pseudobinary B.

**Enable *Retransmit* and choose any *Tx Format* but Pseudobinary B to take advantage of Retransmissions.**



Only scheduled transmissions can be retransmitted.

For optimal retransmission performance, please use the following settings:

- ▶ *Radio Type: Cell or Iridium*
- ▶ *Kind: Scheduled*
- ▶ *Format: CSV, Pseudobinary D*
- ▶ *Tx Data Content: All Logged*
- ▶ Setup needs to remain constant; changes to telemetry and measurement setup may result in incorrect sensor data in retransmissions.

### 13.4.3 Notes

- Toggling recording, clearing status, and changing some telemetry settings will clear out any pending retransmissions. Rebooting a station will NOT reset transmissions.

- If the station does not have any data logged for the relevant time period, no retransmission will be made.
- Loss of power cannot be overcome with retransmissions.
- Retransmissions are only useful if the station is still able to collect and log sensor data.
- Data older than 7 days will not be retransmitted.
- If there are pending retransmissions, Telemetry status will show when the first failure happened. E.g., "Retransmissions pending from 2017/11/12 12:30:00"
- Each telemetry setup has its own retransmissions.

## 13.5 File Transmissions

A system equipped with a cell modem can transmit files via FTP. The operation requires an SD card. Python scripts must be used to create the files for transmission.

Please see [File Transmissions](#)

## 14 Logging

---

XLink automatically logs the sensor data that it collects (see [10.7 LOGGING SETTINGS](#)). Data is logged on secure flash memory with a capacity of over 1,000,000 entries. Each log entry uses an IEEE 64 double precision float to represent the sensor reading.

Log usage and capacity information is available in the main status. For more details, use the STATUS LOG command.

- ▶ Measurement readings are logged according to the *Logging Interval* (see [10.7.1 LOGGING INTERVAL](#)). Each measurement has its own logging interval.
- ▶ Logged data will *not* be lost if power is removed. Once the log is full, the oldest data will be overwritten.
- ▶ Only logged data may be transmitted.
- ▶ The system logs events such as power up, log download, and setup change.

When downloaded, the data is presented in Sutron Standard CSV format. It is a format common to current Sutron products. A log entry looks like this:

```
04/02/2012,09:25:00,STAGE,20.50,FT,G
```

- ▶ date and time (with a one-second resolution)
- ▶ user set measurement label (STAGE)
- ▶ measurement reading (20.50)
- ▶ user set measurement units (FT)
- ▶ measurement quality (G = good, B = bad)

The general format specification for Sutron Standard CSV format is:

```
mm/dd/yyyy, hh:mm:ss, label, data, units, quality
```

Here are some examples of log entries:

- ▶ 01/19/2015,09:30:00,Stage,1.25,ft,G
- ▶ 01/19/2015,09:45:00,Stage,1.27,ft,G
- ▶ 01/19/2015,09:50:27,Setup Change,,G

To help preserve data integrity and reliability, there is no way to erase data from the log.

### 14.1 Downloading the Log

Logged data can be downloaded using LinkComm or via a terminal program using the LOG command. Additionally, plugging in a USB thumb drive into the station will automatically download the log.

The downloaded data is in Sutron Standard CSV format and can be easily displayed using Sutron's GRAPHER program (downloadable from [WWW.SUTRON.COM](http://WWW.SUTRON.COM)) or common spreadsheet/word processing programs.

You can download the whole log or only parts of it. You may specify the start date and optionally the end date for the downloaded data. You may also ask for data from the last X days. Downloading via the USB thumb drive will download all the new data since last download.

There are options to download only data from a specific measurement. Events can be excluded from the log download.

The station remembers the last log download and will allow downloads since last download. This means that the only parts of the log downloaded are those that have not been previously downloaded.

## 14.2 Log Events

Occasionally, the system will log events. Events are used to help in troubleshooting and station maintenance.

The following are some of the actions that will cause the station to log an event:

- ▶ Setup change (when any setting is changed)
- ▶ Log download (when the log is downloaded)
- ▶ Reset (log contains reset type and count)
- ▶ Errors (such as low battery and sensor failure)
- ▶ Before cal and after cal (logged when the user sets the sensor level to record the value before and after the calibration)
- ▶ Log in events (if password is enabled), including failure to log in.
- ▶ Telemetry events (transmission made, message received, etc.)
- ▶ Alarm events

The setting *Log Daily Values* (see [12.2 LOG DAILY VALUES](#)) determines whether certain log events are logged every day before midnight.

The setting *Log Diagnostics* (command line only) sets the software to log diagnostic information.

## 14.3 Logged Time

Measurements are not instant. Once initiated, a measurement takes the user-defined averaging time, plus some overhead, to complete.

For measurements without averaging, **the timestamp of the logged measurement is the time the measurement was started.** The same is true for transmissions. The timestamp of the transmission is the time when the transmission process was started, not when it was completed.

This means that if a SDI-12 sensor takes 1 minute to provide a result, and the measurement is setup to go every 15 minutes, the measurement will start at 00:15:00 and complete at 00:16:00. The logged data will have the timestamp of 00:15:00.

The system handles averaged readings in such a way that the last sample is collected at *Meas Time + Meas Interval*. Please see section [10.2.3 AVERAGING TIME, SAMPLING INTERVAL, SUBSAMPLES, AND RESULTS](#) for details.

Minimum and maximum values are logged at the time the minimum or maximum occurs, not when the measurement was scheduled. This provides knowledge of the exact time the maximum or minimum happened.

## 15 Errors

---

During operation, the system may notice errors. If it does, it will blink the red LED on the front panel.

To see the error details, check the status with LinkComm. Via command line, type STATUS to see any potential errors.

### 15.1 Clearing Errors

Some errors can only be cleared by fixing the condition that is causing them. Most errors can be cleared with LinkComm's Clear Status button on the main tab. On the command line, type STATUS 0 to clear the errors.

### 15.2 Measurement Errors

Measurement errors occur as the system collects sensor data. When data from the sensor contains an error, that error is logged along with the sensor reading. The system notes this error until the error is cleared. Even if the error were to occur only once, it remains in the system until cleared.

#### 15.2.1 Sensor Failure

This error indicates a problem with a sensor or a setup. This error is recorded for SDI-12 sensors when the SDI-12 sensor does not reply to the measure and to the data commands. It is also recorded for analog measurements when the analog to digital converter indicates a problem reading the input which could be to the input voltage being out of range or not being connected (the system cannot always be able to tell if an analog sensor is present).

When the sensor failure error occurs, the system changes the sensor reading to match the user set *Log Error Value*, which defaults to -99999. Such outlandish numbers are used to attract the user's attention when viewing the log.

#### 15.2.2 Meas Interval Too Short

If this error is present, then the measurement schedule is inappropriate.

This error means that the station missed a scheduled measurement. This gets logged when the system realizes that more than one measurement interval has passed between two subsequent measurements. One of the following likely took place:

- ▶ The system missed a scheduled measurement (likely due to measurement taking longer than *Meas Interval* to complete – e.g., system was told to measure every 5 seconds even though the sensor takes 10 seconds to finish a reading)
- ▶ *Equations* are enabled, and the *Meas Interval* is short (once a second or once every two seconds). The system may take several seconds to compute a lengthy equation and cannot complete a measurement as quickly.

### 15.2.3 Sampling Too Short

This happens when the sensor response time is longer than the sampling interval. SDI-12 readings are a good example: if a sensor requires 10 seconds to produce a reading, and the sampling interval is 10 seconds, this error gets set.

### 15.2.4 Averaging Too Short

The averaging interval is either shorter than the sampling interval or than the sensor reply time.

### 15.2.5 Bad Setup

This error is recorded to indicate one of the following:

- ▶ The equation processor reported an error (could be a divide by 0 or syntax error)
- ▶ A meta measurement referenced an inappropriate measurement
- ▶ The SDI-12 Command was set to an invalid value
- ▶ The SDI-12 sensor did not provide enough data values in the result (check *SDI-12 Param*)

### 15.2.6 Bad Wind Setup

See section [10.3.6 MEASURE TYPE: WIND](#).

## 15.3 System Errors

### 15.3.1 Recording Off

If recording is turned off, the station is not collecting data. That is why this condition is considered an error. This error persists until recording is turned on.

### 15.3.2 Time Not Set

This error is noted when the system does not have valid time. This error can only be fixed by setting the clock or waiting for the system to get network time.

The system has an RTC (real time clock) backed by an internal battery. The clock is set at the factory. The RTC keeps ticking even if the main battery is removed. This means that the station should not forget the correct time when it loses power. The battery life is more than five years.

### 15.3.3 Battery Low

The system considers any battery voltage below 9.00 V to be an error in an effort to indicate that the battery needs to be changed. The system will not make any measurements or transmissions when the voltage is too low. Please see the section [12.4 CUTOFF](#) for more details.

The only way to fix this error is to provide a sufficient power supply.

### 15.3.4 Transmission Failures

A variety of issues can cause problems with transmissions:

- ▶ Two or more consecutive transmissions failing cause an error.
- ▶ If more than 25 percent of total transmissions fail, an error is flagged.
- ▶ If no measurements are set up to be included in the transmission data, the system flags an error.

### 15.3.5 Hardware Failure

This error is recorded if any hardware issues were noted since boot up. The errors will also be placed in the log. Every hardware error has a code logged with it. A hardware error usually indicates a serious problem with the unit. Contact Sutron customer support at 703 406 2800 for help with hardware errors.



# 16 Transmission Data Formats

## 16.1 Pseudobinary B Data Format

This format is based on GOES Pseudobinary format. It is used when the user selects *Pseudobinary B* as the choice for *Tx Format*. The format uses ASCII characters. Three bytes are used for each data value. To correctly decode the measurement, you need to know how many readings of each measurement are included in the transmission. There is no metadata that would describe which measurement is which.

### 16.1.1 Pseudobinary B for non-Random Tx

If the Pseudobinary B format is used for any transmission type except Random, it will have the fields listed below. Scheduled and Alarm transmissions will use this format.

Field	Pseudobinary B for Scheduled and Alarm Tx
BLOCK IDENTIFIER	BLOCK-IDENTIFIER is always sent as B to indicate the start of a binary data group.
GROUP ID	GROUP-ID is sent as 1 to indicate a scheduled transmission. Random and alarm transmissions send 2. Forced send 3, while retransmissions send 4.
OFFSET	Each record is prefixed with an <OFFSET>, which is a 1-byte binary encoded number indicating the number of minutes ago the most recent data was recorded.
MEASUREMENT DATA	Measurement data collected: This data contains only those measurements set up to be included in the transmission (see <i>Tx Data Content</i> ). The data values are 3 byte binary encoded signed numbers allowing a range of: -131072 to +131071. The actual 6-bit binary encoded format is described later. The value transmitted will be value * 10 <sup>RightDigits</sup> . The string /// will be sent if the data was never measured or was erased.  The number of values sent for each measurement is set separately for each measurement in the Scheduled Transmissions, Num values to Tx field. Note that this is different from the 8210 where the num values to Tx was the same for each sensor. As a result, the station sends all the required values for one sensor (most recent first) before proceeding to the next measurement. In the 8210, values were interleaved.
BATTERY VOLTAGE [OPTIONAL]	This is an optional 1-byte binary encoded number representing the battery voltage of the station. This value is appended only if the correct Append Option is selected.  If the battery reading is zero, then that is the first transmission since bootup.



Field	Pseudobinary B for Scheduled and Alarm Tx
	The range of the Pseudobinary number is -32 to +31 and can be converted to volts by multiplying by 0.234 and adding 10.6 allowing a range of 3.1 to 18.1 volts.
STATION NAME [OPTIONAL]	This is a variable length, space delimited field that contains the station name. Space delimited means there is a space before and a space after the station name. If the station name were set to SmallCreek, the transmission would contain " SmallCreek " Note the space before and after SmallCreek. The quotes are NOT included.
TX TIME [OPTIONAL]	The time is a 3 byte, binary encoded, signed number without any right digits. It represents the number of seconds since midnight.
SERIAL NO [OPTIONAL]	A space-delimited, variable length ASCII field containing the serial number. See station name above for details.
TX COUNT [OPTIONAL]	A total of six bytes are used to hold the tx count. The first 3 bytes are the total number of good txs made; the second 3 bytes the number of bad txs. Each of the two values is encoded as a binary 3-byte value with no right digits.

### 16.1.1.1 Pseudobinary B Scheduled Example

Here is a transmission with three active measurements; each one is set to include two readings:

```
B1@@Gt@Gs@Sx@Sr@@i@@iL
```

Decoding the message

Pseudobinary values	Decoded into decimal	Completely decoded	Description
B			Denotes Pseudobinary B format
1			Scheduled transmission
@	0	0 min	Delta time
@Gt	500	5.00	Stage #1
@Gs	499	4.99	Stage #2
@Sx	1272	12.72	Precip #1
@Sr	1266	12.66	Precip #2
@@i	41	41	Temp #1
@@i	41	41	Temp #2
L	12	13.4V	Battery voltage (12*0.234+10.6 )

## 16.2 Pseudobinary C Data Format

This format is based on the pseudobinary B format. It uses slightly more bandwidth than the B format, but it is self-descriptive. It is used when the user selects *Pseudobinary C* as the choice for *Tx Format*.

Block identifier	1	BLOCK-IDENTIFIER is always sent as C to indicate that this is the pseudobinary C format.
Group id	1	GROUP-ID can be 1 to indicate a scheduled transmission, 2 meaning an alarm transmission, 3 indicating a forced transmission, and 4 indicating a retransmission.
Measurement Delimiter	1	This byte is always a +, and it is used to denote the start of measurement data.
Measurement Index	1	This is encoded 6 bit binary encoded (see below) number which, when translated, tells the measurement index. The station assigns a measurement index (starting with 1 and ending with 16) to each user setup sensor.
Day	2	This 2 byte encoded 6 bit binary encoded (see below) number represents the Julian day of the year. The day tells when the most recent (first) sensor reading of this measurement was made.

Time	2	This 2 byte encoded 6 bit binary encoded (see below) number is a number of minutes into the day. It tells when the most recent (first) sensor reading of this measurement was made.
Interval	2	This 2 byte encoded 6 bit binary encoded (see below) number tells the measurement interval in minutes or the amount of time between readings of this measurement.
Measurement Data	3 for each sensor reading	Measurement data collected: This data contains only those measurements set up to be included in the transmission (see Tx Data Content). The data values are 3 byte binary encoded signed numbers allowing a range of -131072 to +131071. The actual 6-bit binary encoded format is described later. The value transmitted will be value * 10 <sup>RightDigits</sup> . The string /// will be sent if the data was never measured or was erased. All the required values for one sensor (most recent first) before proceeding to the next measurement. This format is similar to that used by the Sutron Satlink but different from the 8210. There will be 3 bytes of encoded data for every sensor reading. The number of readings depends on the user setup.
Additional Measurements	Variable	If more than one measurement was set up for transmission, more data will follow. Each measurement setup will have data starting with the Measurement Delimiter and ending with Measurement Data.
Final Delimiter	1	This byte is always . and it is used to denote the end of all measurement data.
Battery voltage	1	This is the battery voltage measured prior to making the transmission. The range of the number will be -32 to +31 and can be converted to volts by multiplying by 0.234 and adding 10.6 allowing a range of 3.1 to 18.1 volts.
Append options	Variable	Please see section <a href="#">16.1.1 PSEUDO BINARY B FOR NON-RANDOM TXS</a> for details.

### 16.2.1 Example of Pseudobinary C

To help understand the message below here is a relevant bit of setup:

M1 Right Digits	2
M1 Meas Interval	00:01:00
M1 Tx Data Content	All Logged
M2 Right Digits	1
M2 Meas Interval	00:01:00
M2 Tx Data Content	Last
Tx Time	00:00:30

Tx Interval	00:03:00
-------------	----------

Here is the message:

```
C1+ABeHq@A@E|@FG@FM+BBeHq@A@@O.K
```

Decoding the message:

Pseudobinary values	Decoded into decimal	Completely decoded	Description
C			Denotes Pseudobinary C format
1			Scheduled transmission
+			Delimiter for next measurement
A	1	M1	Measurement M1
Be	165	June 14th	M1 day of the year of the most recent reading. For 2013, it is June 14th.
Hq	561	09:21AM	M1 minutes into the day of the most recent reading: 9:21AM
@A	1	1 minute	M1 measurement interval in minutes.
@E	380	3.80	M1 most recent sensor reading made at 09:21AM
@FG	391	3.91	M1 sensor reading made at 09:20AM
@FM	397	3.97	M1 oldest sensor reading made at 09:19AM
+			Delimiter for next measurement
B			Measurement M2
Be	165	June 14th	M2 day of the year of the most recent reading.
Hq	561	09:21AM	M2 minutes into the day of the most recent reading.
@A	1	1 minute	M2 measurement interval in minutes.
@@O	15	1.5	M2 sensor reading
.			Delimiter for end of measurement data
K	11	13.2V	Battery voltage (11*0.234+10.6)

### 16.3 Pseudobinary D Data Format

This is another compact data format. It differs from Pseudobinary B in that it has a timestamp at the start of the message. The timestamp indicates when the transmission should have taken place and helps decode when the data was collected. Pseudobinary D is 4 bytes larger than format B.

The timestamp is similar to the one in Pseudobinary C. Pseudobinary D is smaller than Pseudobinary C, and it lacks detailed timestamps that would allow one to completely reconstruct the time the data was collected from the message itself. To correctly use Pseudobinary D, the decoder needs to know the measurement setup used.

The benefit of using Pseudobinary D is being able to correctly decode data regardless of when it was sent or received. This allows stations to re-transmit old data and have it correctly interpreted by the decoder while keeping the message size at a minimum.

Name	Bytes	Description
Block identifier	1	BLOCK-IDENTIFIER is always sent as D to indicate that this is the Pseudobinary D format.
Group id	1	GROUP-ID can be 1 to indicate a scheduled transmission, 2 meaning an alarm transmission, 3 indicating a forced transmission, and 4 indicating a retransmission.
Day	2	This 2 byte encoded 6-bit binary encoded (see below) number represents the Julian day of the year. The day tells when the transmission was originally scheduled to take place.
Time	2	This 2 byte encoded 6-bit binary encoded (see below) number is a number of minutes into the day. It tells when the transmission was originally scheduled to take place.
Measurement Data	3 for each sensor reading	Measurement data collected: This data contains only those measurements set up to be included in the transmission (see Tx Data Content). The data values are 3-byte binary encoded signed numbers allowing a range of -131072 to +131071. The actual 6-bit binary encoded format is described later. The value transmitted will be value * 10 <sup>RightDigits</sup> . The string /// will be sent if the data was never measured or was erased. All the required values for one sensor (most recent first) before proceeding to the next measurement. This format is similar to that used by the Sutron Satlink but different from the 8210. There will be 3 bytes of encoded data for every sensor reading. The number of readings depends on the user setup.
Additional Measurements	Variable	If more than one measurement was set up for transmission, more data will follow. Each measurement setup will have data starting with the Measurement Delimiter and ending with Measurement Data.
Battery voltage	1	This is the battery voltage measured prior to making the transmission. The range of the number will be -32 to +31 and can be converted to volts by multiplying by 0.234 and adding 10.6 allowing a range of 3.1 to 18.1 volts.
Append options	Variable	Please see section <a href="#">16.1.1 PSEUDOINARY B FOR NON-RANDOM TXS</a> for details.

### 16.3.1 Example of Pseudobinary D

To help understand the message below here is a relevant bit of setup:

M1 Right Digits	2
-----------------	---

M1 Meas Interval	00:01:00
M1 Tx Data Content	All Logged
M2 Right Digits	1
M2 Meas Interval	00:05:00
M2 Tx Data Content	Last
Tx Time	00:00:30
Tx Interval	00:05:00

Here is the message:

DID~A8@NI@NH@NG@NF@NE@DGF

Decoding the message:

Pseudobinary values	Decoded into decimal	Completely decoded	Description
D			Denotes Pseudobinary D format
4			Retransmission
D~	318	Nov 14th	Day of the year of the most recent reading. For 2014, it is Nov 14th.
A8	120	2:00 AM	Minutes into the day. We can tell that this transmission should have been made at 02:00 on Nov14th and parse the data accordingly.
@NI	905	9.05	Sensor M1 collected at 02:00
@NH	904	9.04	Sensor M1 collected at 01:59
@NG	903	9.03	Sensor M1 collected at 01:58
@NF	902	9.02	Sensor M1 collected at 01:57
@NE	901	9.01	Sensor M1 collected at 01:56
@DG	263	26.3	Sensor M2 collected at 02:00
F	12	12.00V	Battery voltage

## 16.4 Six Bit Binary Encoded Format

The 6-bit binary format is used to encode numbers into displayable ASCII characters. Fractional numbers cannot be represented, so, for instance, a battery voltage of 13.04 volts set up with 2 right digits will be sent as 1304.

- ▶ A 1 byte encoded number can range from -32 to +31.
- ▶ A 2 byte encoded number can range from -2048 to +2047
- ▶ A 3 byte encoded number can range from -131072 to +131071

Binary encoded numbers are always sent most significant bytes first. The number itself is broken down into 6-bit digits, and each digit is placed in one byte of data. The number 64 (ASCII @) is added to each digit to make it fall within the range of displayable ASCII characters. The only exception is that 127 (ASCII <DEL>) is sent as 63 (ASCII ?)

### 16.4.1 Example 1: Encoding the Number 10 in 1 Byte

Since 10 will fit in 6-bits, we only have to add 64 which would yield 74. So the number 10 would appear as ASCII 74 or the letter J.

### 16.4.2 Example 2: Encoding the Number 12345 in 3 Bytes

- ▶ First, we have to convert 12345 into binary in 6-bit pieces:
  - ▶ 12345 (base 10) = 11 000000 111001 (base 2)
- ▶ Now we can convert each piece back to base 10:
  - ▶ 11 000000 111001 (base 2) = 3, 0, 57
- ▶ Finally, we add 64 to each piece and convert to ASCII:
  - ▶ 67, 64, 121 = ASCII C@y

### 16.4.3 Example 3. Encoding the Number -12345 in 3 Bytes

- ▶ First we have to convert -12345 into two's complement 18-bit binary: -12345 (base 10) = 111100 111111 000111 (base 2)
- ▶ Now we can convert each piece back to base 10: 111100 111111 000111 (base 2) = 60, 63, 7
- ▶ Finally, we add 64 to each piece and convert to ASCII (since the second piece is 63 we leave it alone):
  - ▶ 124, 63, 71 = ASCII |?G

#### 16.4.3.1 Example 4. Decoding the 3-byte string @SW:

This is just like encoding except we follow the steps backward.

- ▶ First we convert all the characters to ASCII decimal codes:
  - ▶ ASCII @SW = 64, 83, 87
- ▶ Now we subtract 64 from each piece and convert to 6-bit binary:
  - ▶ 0, 19, 23 = 000000 010011 010111
- ▶ Finally, we combine all the bits to form one 18-bit two's complement number and convert to base 10:
  - ▶ 000000010011010111 = 1239

## 16.5 Pseudobinary over SMS

Some bytes that are normally used as a part of Pseudobinary transmissions are not allowed in SMS. When the station sends Pseudobinary data over SMS, those bytes are replaced according to the following table:

[	5B	1
\	5C	2
]	5D	3
^	5E	4
`	60	5
{	7B	6
	7C	7
}	7D	8
~	7E	9



## 16.6 SHEF and SHEFFIX Data Format

SHEF is a format that is commonly used by Sutron's satellite transmitters. It is an ASCII format that is easy to read and contains some self-descriptive information.

The format of the transmission data is:

```
: <LABEL1> <OFFSET> #<INTERVAL> <DATA1> <DATA1> ... <DATA1>
: <LABEL2> <OFFSET> #<INTERVAL> <DATA2> <DATA2> ... <DATA2> ...
: <LABEL(N)> <OFFSET> #<INTERVAL> <DATA(N)> <DATA(N)> ... <DATA(N)>
```

LABEL	This is the <i>Label</i> entered as a part of the setup for each measurement. The label can be a SHEF two-character parameter code such as HF for gauge height or PC for cumulative precipitation, or it can be any string you enter. Refer to <a href="http://noaasis.noaa.gov/DCS/htmlfiles/schefcodes.html">http://noaasis.noaa.gov/DCS/htmlfiles/schefcodes.html</a> for a list of SHEF codes commonly used.
OFFSET	This number indicates how long ago the sensor reading was made. The number is in minutes, and it refers to the most recent data. It is relative to transmission start.
INTERVAL	The interval indicates how often the measurement was made. It corresponds to the setting <i>Meas Interval</i> .
DATA	This is data collected and logged by the station through measurements. Only logged data may be transmitted. If <i>Tx Data Content</i> is set to <i>Exclude</i> , no data from that measurement will be transmitted. Like the binary formats, the SHEF format groups all the related data from one measurement. The data is transmitted in ASCII with sign and decimal point (if needed). If a data value has not yet been recorded (or has been erased) the letter M for missing data will be sent. The most recent data is always sent first. The number of values sent for each measurement is set on a measurement by measurement basis.
APPEND OPTIONS	There are a multitude of optional values that may tacked on at the end of the transmission. Please see <b>APPEND OPTIONS</b> .

### 16.6.1 SHEF Example

Here is a message with three active measurements. Each is set to include two readings. The random buffer contains the string EXT. This string was given by an external device through the RS-232 port. Notice how much longer this message is compared to the earlier binary examples.

```
:HG 3 #15 10.20 10.15 :PC 1 #15 50 49 :TA 0 #15 -22.1 -22.0 :VB 0 12.2
```

In the example above `:HG 3 #15 10.20 10.15` means that the sensor labeled HG read the value 10.20 three minutes prior to the start of the transmission. It read 10.15 18 minutes before the start of the transmission, or 15 minutes before it read 10.20. Here is the complete decode:

:HG	Measurement labled HG
3	Reading is 3 minutes old
#15	15 minute measurement interval
10.20	HG sensor reading (most recent)
10.15	HG sensor reading
:PC	Measurement labled PC
1	Reading is 1 minute old
#15	15 minute measurement interval
50	PC sensor reading (most recent)
49	PC sensor reading
:TA	Measurement labled TA
0	Reading is less than one minute old
#15	15 minute measurement interval
-22.1	TA sensor reading (most recent)
-22.0	TA sensor reading
:VB	Battery voltage label
0	Reading is less than one minute old
12.2	Battery voltage reading

SHEFFIX is a modified version of SHEF where the data is positioned in fixed spacing so that it will line up better when displayed. Each measurement reading is given seven bytes. If a reading uses fewer bytes, it is padded with spaces. SHEIFIX transmissions are larger than SHEF transmissions.

16.6.1.1 *SHEFFIX Example*

```
:STAGE 0 #2 20.50 20.50 20.50 20.50 :PRECIP 3 #5 12.00 12.01 :TEMP 3 #5 23.5 23.2
:BV 1 #3 14
```

16.6.1.2 *SHEF Example with Min/Max data included*

When transmitting Min/Max data, the formatter includes a timestamp for each value because the Min/Max data is logged at the time of the occurrence rather than the measurement interval. Note how in the message below the MX and MN only have one value and the timestamp is different for each.

```
:ITEMP 12 #15 25.9018 26.0289 26.0988 26.2451 :MX 64 #60 26.686 :MX 101 #60 27.426 :MN 14 #60
25.891 :MN 131 #60 25.334 :AVG 12 #60 26.169 26.368
```

## 16.7 Sutron Standard CSV

Logs downloaded from the station will be in the Sutron Standard CSV format. It is possible to transmit data in the CSV format. However, CSV messages are large compared to SHEF and Pseudobinary.

The format was introduced in 2009 and is common to current Sutron products. The general format specification for Sutron Standard CSV format is

```
mm/dd/yyyy, hh:mm:ss, label, data[, units, qual][, label, data[, units, qual]]
```

### 16.7.1 Sutron Standard CSV Example

```
04/02/2012, 09:23:45, STAGE, 20.50
04/02/2012, 09:23:50, STAGE, 20.50
04/02/2012, 09:23:53, Setup Change
04/02/2012, 09:24:00, BV, 14
04/02/2012, 09:25:00, PRECIP, 34.5
04/02/2012, 09:25:00, TEMP, 23.5
04/02/2012, 09:25:00, STAGE, 20.54
```

## 16.8 MIS

**MIS** format is a verbose ASCII format that uses tags. Each measurement gets its own section in MIS.

The header includes the station name and the measurement label. The body includes a timestamp and a value for each sensor reading.

The example below illustrates the MIS format for one measurement. If more than one measurement were being transmitted, each measurement would have a section like the one below.

```
<STATION>000DOLPHIN</STATION><SENSOR>00PR</SENSOR><DATEFORMAT>YYYY/MM/DD</DATEFORMAT>
2017/05/24;111500;82.03
2017/05/24;110000;82.04
2017/05/24;104500;83.11
2017/05/24;103000;83.14
```

In that example

- ▶ STATION and SENSOR and DATEFORMAT are tags that are always present.
- ▶ 000DOLPHIN is based on the Station Name which was set to DOLPHIN. The 000 are padding to fill out to 10 bytes. If the Station Name were longer than 10 bytes, only the first 10 would be in the STATION tag.
- ▶ 00PR is based on the measurement Label, which was set to PR. 00 is padding to fill out to 4 bytes. Up to 4 bytes of the Label can fit into the SENSOR tag.
- ▶ YYYY/MM/DD is the user set Date Format setting.
- ▶ 111500 is the timestamp in HHMMSS format which is 11:15:00

- ▶ 82.03 is the sensor reading. If data is missing, --- is transmitted.

## 16.9 ASCII Column

The ASCII Column format is another means of encoding transmission data. A message formatted with this method would look like this:

```
<CRLF>
Meas1_Data(1) Meas2_Data(1) ... MeasN_Data(1)<CRLF>
Meas1_Data(2) Meas2_Data(2) ... MeasN_Data(2)<CRLF>
Meas1_Data(n) Meas2_Data(n) ... MeasN_Data(n)<CRLF>
```

- ▶ <CRLF> is a carriage return, line feed
- ▶ Meas1\_Data()..MeasN\_Data are the data from the active measurements included in the transmission.
- ▶ All the data on one line are for the same time. A space separates the values. The newest data is sent first.
- ▶ (n) is the number of values included in the transmission as set by the user.
- ▶ The format for any value is ASCII with the right digits set by the user.
- ▶ No decimal point is shown if the value is zero.
- ▶ Add a minus sign in front of the value if the value is negative.
- ▶ There are no leading zeroes.
- ▶ If the value is missing, two forward slashes are transmitted instead //.

A typical message will appear as follows:

```
41.79 60.99 12.99 12.43 .20 8.08 7.1 195.2
41.79 60.99 12.99 12.43 1.20 8.08 7.1 195.2
41.79 60.99 12.99 12.43 -2.20 8.08 7.1 195.2
```

Normally the DCP will be set up, so all the sensors are collected at uniform times. If this is not the case, the formatter will still work but will have varying amounts of data on each line (each time) based on whatever sensors are collected at each time. This will produce confusing results if the additional sensors are collected at an interval of the other sensors. The results should be OK if the additional sensors are collected at a time separate time.

## 16.10 ASCII Sensor

This method of formatting uses four digits for each measurement readings. Measurement readings are multiplied by 100 before being transmitted.

```
<CRLF>
IDIDIDID JJJHHMMSS<CRLF>
Meas1_Data(1) Meas1_Data(2) ... Meas1_Data(n)<CRLF>
Meas2_Data(1) Meas2_Data(2) ... Meas2_Data(n)<CRLF>
MeasN_Data(1) MeasN_Data(2) ... MeasN_Data(n)<CRLF>
optional Battery before transmission<CRLF>
optional Battery under load<CRLF>
```

- ▶ <CRLF> is a carriage return, line feed
- ▶ IDIDIDID is the eight-byte hexadecimal satellite ID
- ▶ JJJ is a three digit Julian Day, which is the number of days of the year. January 1st is Julian Day one, and February 1st is Julian Day 32. This number is always three digits (0 padded)
- ▶ HHMMSS are the hours minutes and seconds. This is the time of the scheduled transmission. It is always 6 bytes (0 padded).
- ▶ Meas1\_Data()..MeasN\_Data are the data from the active measurements included in the transmission.
- ▶ Measurement data is always four digits followed by a space (0 padded).
- ▶ All values are multiplied by a 100.
- ▶ No decimal point is used for measurement data.
- ▶ Range of transmitted data is 0 to 9999 (numbers out of range are transmitted as 0000 or 9999). This means that the sensor data should be between 0 and 99.99 before formatting.

If the user elects to append battery voltage, one of the two will be appended:

- ▶ Two lines of battery voltage information will be added. Both lines take the same format: "12.5<CR><LF>" (three digits of battery voltage and a decimal point). The first line is the battery voltage prior to this transmission. The second line is the battery voltage during the last transmission.

This is an example transmission:

```
010570F2 108183053
0250 0250 0250 0250
2231 2232 2233 2234
12.2
12.1
```

- ▶ On the first line 010570F2 represents the hexadecimal satellite ID. 108 is the Julian Day (for the year 2005, that is April 18th). 183053 means 18 hours 30 minutes and 53 seconds.
- ▶ The second line (0250 0250 0250 0250) shows four readings of the first sensor. This measurement had four same readings. Before formatting, that reading was 2.50. It was multiplied by 100 and padded with a leading zero.
- ▶ The third line (2231 2232 2233 2234) shows four different readings of the second sensor. That sensor's readings were originally 22.31, 22.32, 22.33, and 22.34 respectively. They were multiplied by 100 and padded with a leading zero.
- ▶ The fourth line (12.2) is the battery reading in Volts prior to transmission.
- ▶ The last line (12.1) is the battery reading in Volts during the last transmission.

## 16.11 TCP/IP Session

A station equipped with a cell modem will use scheduled transmissions periodically connect to a server and deliver sensor data. See the section [13.2 CELLULAR TELEMETRY](#) and section [11.1.6 TX FORMAT](#) for more details.

Relevant settings include *Protocol*, *Main Server*, *Backup Server*, *Server Port*, and *Server Password*.

When *Protocol* is set to *Hydromet Cloud*, the station will engage in handshaking with the server. The station will provide the server with information about the transmission that includes the station name, password, reason for the transmission, and error checking information. The server will acknowledge the transmission.

If the server does not acknowledge the transmission, the station will retry the transmission until it succeeds or until it times out.

When *Protocol* is set to *None*, the station will not engage in handshaking with the server.

If you are using a custom server, you will want to set *Protocol* to *None*. Either that or have the custom server acknowledge the transmission.

### 16.11.1 Hydromet Cloud Protocol

When the station connects to a server, some information is sent to the server before the sensor data is delivered. This information is meant to help the server decide what to do with the sensor data that is en route. The information includes details such as the sensor name and whether the transmission is a result of an alarm event.

After the sensor data is delivered to the server, the server may log into the station and issue commands to check status, change setup, download more data, or any other command line activity.

### 16.11.2 Course of Events for the Hydromet Cloud Protocol

1. The station connects to main or backup server.
2. The station sends Session Type Code<cr> (see below.)
3. The station sends Station Name<cr>.
4. The station sends Report Type Code<cr> to indicate purpose of connection (see below.)
5. The station sends transmission data (if any) in whatever format the user chose, such as SHEF or pseudobinary.
6. The station sends ETX (0x03) to mark end of data.
7. The station sends a 3 byte pseudobinary encoded CRC16 of previous data and the server password (sometimes called Shared Secret.)
8. The station waits for the server to either acknowledge or to initiate a command line session. The server has 60 seconds to do either one.
  - a. If the server does neither, the station will retry the transmission until it succeeds or until it times out.

9. To acknowledge, the server needs to send a single byte: <cr>
  - a. Once the server sends the byte, the station will disconnect.
10. To initiate a command line session, the server sends user login command !LOGIN=username,password<cr> and waits for the station to reply (ETX.)
  - a. If user login matches, the station enters command-line session.
  - b. Server issues pending commands, and the station processes and responds accordingly.
  - c. When command processing is complete, the server disconnects.

#### 16.11.2.1 Session Type Code

Session type defines the processing that occurs on connection. Currently, there is only one session type, 1. This type is defined by the Course of Events above, and details that follow.

#### 16.11.2.2 Report Type Code

Report Type code describes the purpose of the transmission:

- ▶ 0 = self-timed
- ▶ 2 = entering alarm
- ▶ 4 = exiting alarm
- ▶ 6 = no data, command session only

## 16.12 Iridium Telemetry Header

When the station sends data over the Iridium satellite network, it uses the header described below.

The header starts with a single byte in the ASCII printable range to make it easy to interpret the content. Most transmissions will just have one header byte.

The header byte identifies the packet type in terms of the content of the packet, e.g., self-timed, self-timed extended, entering alarm, entering alarm extended, etc.

Iridium modem buffers are limited in size. "Extended" types mean multiple packets are required to transmit the entire message. Extended packets have information in the header that allows them to be stitched together easily. The extended packet types include a comma-delimited sub-header to describe the subset of data being sent. The first sub-header differs from all subsequent sub-headers, in that it includes the total size of the data being sent.

The telemetry header may contain the station name if the setting *Tx Station Name* is enabled. Please read below for more details.

### 16.12.1 Packet Structure

Packets are composed of

- ▶ packet-type
- ▶ sub-header
- ▶ data

The packet-type is a single byte:

Hex Value	ASCII	Description
0x30	0	Self-timed
0x31	1	Self-timed extended
0x32	2	Entering alarm
0x33	3	Entering alarm extended
0x34	4	Exiting alarm
0x35	5	Exiting alarm extended
0x36	6	Command response
0x37	7	Command response extended
0x38	8	Forced transmission
0x39	9	Forced transmission extended
...		Reserved for future use
0x7D	}	User defined
0x7E	~	Look to next byte for meaning
0xFF		Binary data, reserved for future use

The sub-header has the following comma-delimited fields:

- ▶ ,id,start-byte,total-bytes,station-name:

packet-type	Numeric ASCII character-defining packet type. See type definitions in table, below
id	Numeric ASCII text defining the message id. Starts at 0. Rolls over after 99.
total-bytes	Numeric ASCII text defining the total number of data bytes to be sent (data only, does not include overhead bytes)
start-byte	Numeric ASCII text defining which byte of total-bytes is the start byte of the current packet. Starts at 0.
station-name	Optional ASCII field that has station name. Formatted as ,N=STATION NAME

### 16.12.2 Iridium Header Examples

The following examples illustrate how to use the new header.



16.12.2.1 Example 1

Message requiring one packet (i.e., non-extended), formatted pseudobinary B interleaved, containing 6 values (42, 69, alternating).

Self-timed	0B1@AAhAktAAhAktAAhAkt
Entering Alarm	2B2@AAhAktAAhAktAAhAkt
Exiting Alarm	4B3@AAhAktAAhAktAAhAkt

16.12.2.2 Example 2

The same data in SHEF format:

Self-timed	0:HG 0 #1 42.00 42.00 42.00 :EM 0 #1 69.00 69.00 69.00
Entering Alarm	2:HG 0 #1 42.00 42.00 42.00 :EM 0 #1 69.00 69.00 69.00
Exiting Alarm	4:HG 0 #1 42.00 42.00 42.00 :EM 0 #1 69.00 69.00 69.00

16.12.2.3 Example 3

An extended command response where the total size of the command response is 512 bytes (note: total size is of the response itself, and does not include the overhead of the telemetry headers used to convey it). The example uses a message id of 0:

Packet 1	7,0,0,512:bytes 0 thru 319
Packet 2	7,0,320:bytes 320 thru 511

16.12.3 Iridium Tx Station Name

There is an option to include the station name in the Iridium Header. The setting is called *Iridium Tx Station Name*, and it defaults to disabled. That setting is accessible only via the terminal (LinkComm->Tools Menu->Terminal). To enable it, type

*Iridium Tx Station Name = On*

- ▶ After all the headers, system will append ,N=Station Name:
- ▶ If the station name were Two Creeks, it would be ,N=Two Creeks:

Standard	With Station Name
0B1@AAhAktAAhAktAAhAkt	0,N=Two Creeks:B1@AAhAktAAhAktAAhAkt
4:HG 0 #1 42.00 42.00 42.00 :EM 0 #1 69.00 69.00 69.00	4,N=Two Creeks::HG 0 #1 42.00 42.00 42.00 :EM 0 #1 69.00 69.00 69.00
7,0,0,512:bytes 0 thru 319	7,0,0,512,N=Two Creeks:bytes 0 thru 319
7,0,320:bytes 320 thru 511	7,0,320:bytes 320 thru 511

For extended packets, only the first message carries the station name. The name field comes after all the other headers.

## 17 Command Line Interface

---

XLink uses a command line interface. You can use a terminal program instead of LinkComm to talk to the station. All features are available over command line. In fact, LinkComm uses the command line interface to talk to the station. When messages are sent to the station via SMS or Iridium, they use the same format as regular command line communications.

### 17.1 Why Use Command Line?

LinkComm provides an easy, user-friendly way to interact with the station. You should never *have* to use the station's command line interface. However, some people prefer command-line interactions. Also, if you want to send an SMS or an Iridium message to check the station status, you would need to find out what the command for checking status is.

LinkComm cannot send messages to the station. SMS messages may be sent to the station from a cell phone, and Iridium messages may be sent via email.

### 17.2 About the Command Line Interface

The command line interface provides a way to interact with the station. Any terminal program can be used to connect to the station. You can connect via the RS-232 port, USB port, or attach to the TCP/IP address of a station that has a Cell modem. You can send and receive messages to and from the station via SMS or Iridium.

By default, the RS-232 interface operates at 115200 Baud, no parity, 8 data bits, 1 stop bit. The system supports hardware handshaking; its use is recommended. Allow at least a half-second between opening the communications port and starting communication.

To start command line mode, send carriage return or line feed (or both). If using a terminal program, press ENTER. The station will respond with a prompt >

Once in command line mode, type HELP to get a list of supported commands. Also, try HELP SETUP.

While it is not recommended, changing the baud rate can be done by typing BAUD RATE. The default baud rate is 115200.

With the terminal program, if the emulation is set for VT100, pressing the up arrow brings back the last typed command.

Messages can be sent to the station remotely. Messages are treated like command line input with a few differences. Some commands cannot be executed via a message. Other commands may have a differently formatted output (in order to reduce message size).

Units with a cell modem can receive SMS (text messages). Units with an Iridium modem can have messages sent to via emails that get routed through the Iridium system. See the section [13.1.4 SENDING MESSAGES TO THE STATION VIA IRIDIUM.](#)

The last message received since boot up can be viewed via the front panel, under the diagnostics menu.

When the station receives a message, it handles the input just as if it were on the commands. For example, issuing the command M1 ACTIVE = OFF would turn off measurement one. Normally, the command is executed, and no feedback is provided.

**If a reply to the message is required, the command in the message must be preceded with an exclamation point. For example, sending a message with the data M1 MEAS will not cause a reply message. Sending ! M1 MEAS will result in a reply. Sending STATUS will do nothing. To get the status, precede the command with a ! ISTATUS**

Several commands can be sent in the same message. Separate the command with a new line or with a semicolon:

```
!M1 MEAS; !STATUS;
```

Please note that since semicolon is a separator, one may not change any setting to contain a semicolon via SMS. For example, one could not change TX1 SERVER PASSWORD to "abc;123;" via SMS.

A password-protected station requires that the first line of the message be the LOGIN command. Here is a message telling the station to turn off digital output 1 and return the status:

```
LOGIN=XXX; OUTPUT1 OFF; !STATUS
```

## 17.3 Status

To check the status, type STATUS (or just S).

## 17.4 Setup

To view the whole measurement setup, type SETUP. To view just the setup of measurement one, type M1. Likewise, M2 shows the setup of the second measurement. For transmissions, use TX1. Only pertinent

data is shown. If a measurement is not active, it will not show its setup fields. If a measurement is of type analog, it will not show its SDI-12 setup fields.

The command SETUP NONDEFAULTS only shows the fields that have been changed from defaults.

An easy way of setting up your station is to type WIZARD or just W. A setup wizard will guide you through the most commonly used settings of the station and of each measurement. The setup wizard may be used to configure one specific measurement: typing M1 WIZARD or M1 W will set up measurement one. TX1 W will setup transmission one.

Every setup field can be changed by typing *setup = value* where setup is the name of the field and value is the new value. By just typing the name of the field, the current value and the range of the field are shown.

For example, typing STATION NAME shows the current station name. Typing STATION NAME = SUTRON changes the station name.

```
>STATION NAME
Setup NOT changed
Station Name = DEMO, max length 23
```

To change setup try STATION NAME = SUTRON.

```
>STATION NAME = SUTRON DEV 1
Setup changed
Station Name = SUTRON DEV 1, max length 23
```

Changing measurement setup fields requires that the measurement be named. For example, to change the *Measurement Type* it is not enough to type MEAS TYPE. You need to provide the number of the measurement in question: M1 MEAS TYPE shows the *Measurement Type* of the first measurement. M2 MEAS TYPE works for the second measurement.

```
>M1 MEAS TYPE
Setup NOT changed
Meas Type = SDI-12, Range (0=Precip Accumulation, 1=Precip Rate, 2=SDI-12, 3=Analog,
4=Battery, 5=Wind, 6=Digital, 7=Meta, 8=Manual Entry, 9=Internal Temp, 10=Accubar
Pressure, 11=Accubar Temp)
To change setup try Station Name = Sutron
```

In the example above, the user typed M1 MEAS TYPE, which will show the measurement type field of the first measurement. The example shows the type as being *Internal Temp*. After the current type is shown, the range shows all the options for the measurement type. To set up the measurement as SDI-12, the user may type either M1 MEAS TYPE = SDI-12 or M1 MEAS TYPE = 2.

Setting the whole setup to defaults can be accomplished by typing SETUP DEFAULTS. Setting just measurement one to defaults can be done via M1 SETUP DEFAULTS.

## 17.5 Measurements

To view the setup and the last reading made measurement one, type M1. Use M2 for measurement two, etc.

To view all the last measured readings, type LAST. It will show a reading for every active sensor. Typing LAST does not initiate new measurement.

To initiate a new measurement for each active sensor, type MEAS. The station will measure each sensor one at a time and display results as it goes along.

If you are interested in only one specific measurement, try M1 LAST and M1 MEAS. Those will show the last measured value and initiate a new measurement, respectively

To change the current reading of a sensor, type M1 = 12.5. This will change the *Measurement Offset* such that the said measurement reads the user entered value. For example, if my water level sensor, once set up, read 3.50, and I knew the water level was at 1.50, I would type M1 = 1.50. The next it was measured, M1 would read 1.50 (assuming the level does not change). The *Measurement Offset* would have changed from 0 to -2.00.

## 17.6 Recording

To start the station, click the Start button in LinkComm, or type RECORDING = ON.

## 17.7 Downloading the Log

The system will save the measured data in its flash memory each time a measurement is made. The command LOG command will start a transfer of the log to the connected device.

- ▶ Use NH to exclude the header; Use NE to omit events.
- ▶ Help Log gives details on downloading the log.

```
>HELP LOG

DOWNLOAD or LOG will transfer the log from the unit
LOG ALL gets whole log, just LOG gets since last download,
LOG X gets X last days ("LOG 3" gets last 3 days worth of data)
LOG timeStart gets data since provided date
LOG timeStart timeEnd gets data between provided dates
time can be YYYY/MM/DD HH:MM:SS or YYYY/MM/DD or HH:MM:SS
eg. "LOG 12:00:00 13:00:00"
eg. "LOG 2006/01/20 12:00:00 2006/01/21 12:00:00"
append M1 to include only data from measurement one
eg. "LOG 3 M1 M2
append NH to omit log header, NE to omit events
NY for no YModem, NL to not update last download time
FE to flag events
```

## 17.8 Machine-to-Machine Communication

All commands may be preceded with an !. If they are, there is no echo, and a concise reply meant for machine-to-machine interaction is returned.

Commands would be preceded by an ! if they were sent by an Xpert or some such computer. For example, instead of typing SETUP, you may type !SETUP.

When command are preceded with an !, no help text is given, no range is shown for measurement, no confirmation of commands is shown, and no key stroke is expected between scrolling pages.

## 17.9 Command Reference

Documentation Legend:

- ▶ 0 If a 0 follows a listed command, it means that the command can optionally be followed by the character 0. E.g., DIAG will show the system diagnostic status. DIAG 0 will first show current status and then clear the status.
- ▶ [Mx] indicates specifying a measurement is optional, e.g., M10
- ▶ TXx specifies a transmission, e.g., TX1

**All commands may be preceded with an !. If they are, a concise reply meant for machine to machine interaction is returned. Commands would be preceded by an ! if they were sent by an Xpert or some such computer.**

**E.g., MEAS will show**

**Measurement M1 Sense1 reading**

**2.17**

**2015/11/24 17:43:11**



**!MEAS will show**

**M1 Sense1, 2.17, 2015/11/24 17:42:24,**

**Every setup variable can be viewed by typing its name.**

**E.g., STATION NAME will show the current name.**

**Every setup variable can be changed by typing its name = new value.**

**E.g., STATION NAME = STURON will set the current name to SUTRON.**

**For a list of all the setup names, type "SETUP".**

### 17.9.1 List of Commands

Command	Description
BATTERY	BATT shows the current power supply battery reading.

Command	Description
BATT COIN	BATT COIN shows the voltage of the internal coin cell battery.
CUTOFF SYSTEM HIGH CUTOFF SYSTEM LOW CUTOFF TX HIGH CUTOFF TX LOW CUTOFF TEMP TX HIGH CUTOFF TEMP TX LOW CUTOFF DEADBAND	See <a href="#">12.4 CUTOFF</a> for additional details  Cutoff Tx High = 20.00 V, Range (14.00, 20.00) Cutoff Tx Low = 9.00 V, Range (9.00, 13.00)  Cutoff Temp Tx High = 85.0 C, Range (40.0, 100.0) Cutoff Temp Tx Low = -45.0 C, Range (-80.0, -20.0)
DIAG [0]	Shows system reset count. If followed by 0, it will clear system resets. Use GET DIAG to access system diagnostics.
DIN1 DIN2	Shows state of digital input.  >DIN1 DIN1 is ACTIVE >DIN2 DIN2 is NOT active
DOWNLOAD	See LOG
EXIT	Quits command line.
ERROR	Lists current errors. Clear with STATUS 0
FACTORY DEFAULTS	This command sets the setup to defaults, clears status (which includes system errors and transmission counts), zeroes reset counts, and clears asserts.
GET DIAG	Provides comprehensive diagnostic information, including status and setup.
HELP HELP SETUP HELP LOG HELP TX HELP LOGIN HELP SDI HELP POWER HELP OUTPUT	Brings up the help (lists commands).
HI	System replies with Hello and blinks green LED.
IRIDIUM MSG CHECK	Used to check for messages from the Iridium gateway. May incur monetary charge.
[Mx] LAST [SCHED] [CSV]	Shows the last measured reading of every active measurement. This command does not make a new measurement, only shows the last results of the last measurement. If preceded by the measurement designator (E.g. M1 LEAS), it shows only one sensor. SCHED If provided, the last scheduled reading is shown. CSV If provided, the data is formatted in Sutron Standard CSV (same format used for logged data) for both normal and machine mode access.



Command	Description
LOG	This command is used to download the log. Try LOG HELP. See Downloading the Log section above for more details.
LOG DIAGNOSTICS	Enable the logging additional diagnostic values. Not recommended except for troubleshooting.
LOGIN	To log into a password protected station, type LOGIN=XXX where XXX is the password. Optionally, type LOGIN=USERNAME,XXX and USERNAME will be ignored. See PASSWORD below.
M1..M32	Type M1 to see the setup of the first measurement. Type M2 to see the setup of the second measurement. Type M1 SETUP DEFAULTS to change to defaults only the setup of measurement one. Type M1 LAST to see the last measured value, and type M1 MEAS to make a new reading. Additionally, you may say M1 = 15.0 to calibrate the sensor.
[Mx] MEAS [CSV] [TRIGGER]	Use this to make a measurement on all or some sensors. After receiving this command, the station will measure every active sensor and display the results. If preceded by the measurement designator (for example, M1 MEAS), it measures only one sensor. The CSV option may be used to get data formatted in Sutron Standard CSV format The TRIGGER option (ver 8.10 or newer) may be used to trigger a measurement but not wait for its completion.
NEXT	Shows next scheduled time of active measurements. Shows "not scheduled" if there is no next measurement.
OUTPUT1 OUTPUT2	This command controls digital outputs. OUTPUT1 controls power to digital output DOUT#1 OUTPUT1 ON turns on, OUTPUT1 OFF turns off OUTPUT1 PULSE 500 turns on for 500ms, then turns off Ditto for OUTPUT2 which handles DOUT#2
PASSWORD PROTECTION	Used to enable password protection on a station. Maybe set to Disabled, Setup, Maintenance, or Full. Setup the passwords BEFORE enabling password protection. See <a href="#">8.2 PASSWORD PROTECTION</a>
PASSWORD READ = X PASSWORD MAINT = X PASSWORD SETUP = X	Access to writing the three passwords for the system, where X is the new password.
POWER	POWER lists the state of SW-12V #1, #2, PROT12, and RS-232 PIN-9 POWER port ON turns on power to the port POWER port OFF turns off power to the port POWER port PULSE duration turns on for duration ms, then turns off port may be SW1, SW2, PROT12, RS-232, VREF, or PREF SW1 and SW2 may not turn off if they're being controlled elsewhere in the system.
REBOOT	Does a software resets of the system.



Command	Description
RS232 BAUD RATE	RS232 Baud Rate = 9600, Range (0=9600, 1=19200, 2=28800, 3=38400, 4=57600, 5=115200, 6=230400, 7=460800, 8=921600), Default = 9600 If using the Sutron Display (LCD 2x20 6 button), make sure to issue command RS232 BAUD RATE = 9600
SDI-12 [POWER ON/OFF] [port] [FIND] [command]	Exercises the SDI-12 buses. Port may be PORT1, PORT2, RS485. If not specified, PORT1 is used. If FIND is included, then port is scanned for sensors If POWER is included, it may be used to control power to the specified port Command indicates a specific command to send on the bus If neither FIND nor command are specified, system issues "?!". e.g. of valid commands: SDI-12 SDI-12 0M! SDI-12 PORT2 0! SDI-12 FIND "SDI" may be used in place of "SDI-12"
SETUP	If provided without any other parameters, it lists all setup details. That includes each setup variable and its current value. Can be followed by a setup variable name and a new value for that variable. E.g. STATION NAME = SUTRON If SETUP DEFAULT is issued, it will reset the entire setup to defaults.
SMS SEND PHONE_NO [more]	SMS SEND 17034062800 will send an SMS to said phone. PHONE_NO must contain the phone number as a string of numbers (no spaces, no dashes), e.g. 17034062800. If the keyword more is included after the phone number, the user may type in the content of the message to be sent. Finish providing content with an ETX (Ctrl-C).
S [0] STATUS [0]	Shows system status including time, boot time, battery readings, last measurements, current internal sensor readings, and any hardware errors that may exist. If followed by 0, it clears the hardware errors. In lieu of the full word STATUS, you may use S
STATUS ALARM STATUS CELL STATUS IRIDIUM STATUS LOG STATUS SCRIPT STATUS TX [Tx] STATUS	Shows details for Alarm, Cell, Iridium, Log, Script, or Transmission status. [Tx] STATUS shows info about said transmission.
TEMP	Returns internal temperature.

Command	Description
TIME	Shows the current system date and time. If followed by a new time, it changes the system time. E.g. TIME = 2008/12/12 changes the date. TIME = 10:15:30 changes the time.
TXx [SETUP] [STATUS] [COUNT]	Shows information about the specified transmission. Setup will show the satellite type and kind for environmental satellite radios. For other radios, it will have the radio type, e.g. Iridium Status gives an idea of what is going on with the transmission. If there is a transmission in progress, it gives details about it. If no tx is in progress, last tx results are shown. If there is no last tx info, next tx time is shown. If there is no next tx (recording is off), it just shows "Enabled" Count tells the number of good and bad transmissions made. Right now, it's the lifetime count. I hope to change it to be the daily count
TXx TXFORM [REPEAT YYYY/MM/DD HH:MM:SS]	Creates a transmission data buffer along with diagnostic information.  The REPEAT option along with the time stamp may be used to get missing data. Please see section <a href="#">13.3.2.3 REPEAT Tx DATA</a>  >TX1 TXFORM Tx data would look like this  :BATT 2 #10 11.347 11.423 11.385 11.377 M M :TEMP 2 #10 26.00 25.25 25.75 26.00 M M :BL -1.00 :PWR -1.0/-1.0  Current message is 108 bytes (00:00:04 seconds) out of 2218 bytes (00:01:00 seconds) Available space is 2110 bytes In that message, sensor data is 83 bytes  Worst case SENSOR data (excluding append) is 138 bytes (00:00:05 seconds) Worst case available space is 2080 bytes 2 meas are active; 2 are marked for tx  >TX1 TXFORM REPEAT :BATT 2 #10 11.347 11.423 11.385 11.377 M M :TEMP 2 #10 26.00 25.25 25.75 26.00 M M
TXx TXNOW	Issue this command to have the system make a transmission as soon as possible.
VER	Shows the current software version, including build date and time and the bootloader version.

Command	Description
VER BOOT	Shows the current software version of the bootloader.
WIFI WIFI ON	Issuing Wi-Fi shows the current state of the station’s Wi-Fi hotspot. Issuing WIFI ON turns on the Wi-Fi for a while, regardless of any Wi-Fi settings. It has the same effect as pressing the front panel button.
WIZARD [Mx] WIZARD [TXx] WIZARD	Guides the user through station set up. Typing M1 WIZARD will do the setup just for measurement one.

### 17.9.2 File Commands

With version 8.33, XLink supports file operations on the SD card via command line.

When on the command line, issuing HELP FILE provides documentation:

```
FILE COPY {source} {destination} [option] copies files and folders
options: -T sTats: shows stats after
FILE CRC {filename} computes CRC32 on file
FILE DEL [options] {name} removes files or folders
Deletes either named file, or named folder and all of its files.
options:
-F files only: delete all files in named folder, but not the folder
-R recursive: recurse through subfolders, deleting all content
-Q quiet: do not output list of deleted files

FILE DIR [options] [path] shows listing of files in path
e.g. FILE DIR -RF /SD
shows ALL files the SD card
options:
-F files only: do not include directories
-D directories only: do not include files
-M machine mode: file name first, comma separated size and time
-P full path: lists full path and file names
-Q quotes: surround file name and path in quotes e.g. "foo.txt"
-R recursive: lists files in path folder and all path subfolders
combine options e.g. FILE DIR -RPS "/my folder/subfolder"
Access the SD card by setting path to /SD

FILE GET [options] {filename} shows contents of file
FILE TYPE is identical to FILE GET
e.g. FILE TYPE -S /SD/file.txt
options:
-C CRC: show CRC of file
-S size: show file size in bytes
-T sTats: shows stats after
-Y YModem: use YModem to retrieve file
filename: the full path to the file of interest

FILE INFO {drive} [options] Show information about drive
Reply indicates if drive is not connected or is not mounted.
Otherwise shows available and total space on drive.
drive: the drive path e.g. /SD
options:
-M machine mode: show byte counts only

FILE LOAD {filename} [size] [CRC] Transfer a file to the system and save it
filename: the full path and name of the file to be transferred
size: the file size in bytes (set to zero if only using CRC)
CRC: CRC32 of the file. If in hex, write as 0x89ABCDEF
FILE APPEND {filename} [size] [CRC] Same as FILE LOAD, but appends data to
existing file

FILE MKDIR {foldername} creates folder(s)
FILE MOUNT {drive} mounts the drive
note drives are automatically mounted
FILE DISMOUNT {drive} dismounts the drive
FILE DISMOUNT SD should be used prior to removing SD card
FILE RENAME {old name} {new name} renames or moves a file or folder
FILE MOVE is identical to FILE RENAME
both {old name} and {new name} need to have a full path
both must be on the same drive
```

### 17.9.2.1 Current Directory

There is not a current directory concept. This is an example of a command used to list files several directories deep:

```
>FILE DIR "/sd/sutron/sutron satlink 3/20150101"  
Sutron Satlink 3_log_20150101.csv      185  
Sutron Satlink 3_diag_20150101.txt    3625
```

#### 17.9.2.2 File and Folder Naming

- ▶ Use forward slash / to separate folders and files
  - ▲ /SD/Sutron/XLink/my\_file.txt
- ▶ Always use the SD folder as the root
- ▶ Do not start file or folder names with hyphen -
  - ▲ If you do, certain commands such as FILE DIR will not work
- ▶ Hyphen - is used for FILE options, e.g. FILE DIR -R
- ▶ Enclose names in quotes if they contain spaces
  - ▲ Say FILE DIR "/SD/Sutron XLink/my file.txt"
  - ▲ This will not work: FILE DIR /SD/Sutron XLink/my file.txt

# 18 More about SDI-12

---

## 18.1 Overview

SDI-12 is a standard for interfacing data recorders with microprocessor-based sensors. SDI-12 stands for serial data interface at 1200 baud.

This product supports SDI-12 version 1.4 starting with firmware version 8.33. Prior to 8.33, SDI-12 1.3 was supported.

SDI-12 is intended for applications with the following requirements:

- ▶ Battery powered operation with minimal current drain
- ▶ Low system cost
- ▶ Use of a single data recorder with multiple sensors on one cable
- ▶ Up to 200 feet of cable between the sensor and a data recorder

SDI-12 has the following advantages:

- ▶ It defines a standard way for a data recorder and sensor to communicate.
- ▶ Unique and complex self-calibration algorithms can be done in the sensor itself.
- ▶ Sensors can be interchanged without reprogramming the data recorder with calibration or other information.
- ▶ Power is supplied to sensors through the interface.
- ▶ The use of a standard serial interface eliminates significant complexity in the design of the data recorder.
- ▶ Low cost, small sensors can be designed with SDI-12 compatibility.
- ▶ SDI-12 data recorders interface with a variety of sensors.
- ▶ SDI-12 sensors interface with a variety of data recorders.
- ▶ Personnel trained in SDI-12 will have skills to work with a variety of SDI-12 data recorders and sensors.

SDI-12 is used in water resource research and management, industry, government, and agriculture. For example, the U.S. Geological Survey uses over 4000 SDI-12 sensors in its data collection networks. SDI-12 sensors are available that measure the following:

- ▶ bridge scour
- ▶ conductivity
- ▶ dissolved oxygen
- ▶ distance
- ▶ groundwater level
- ▶ petroleum hydrocarbons in water
- ▶ pH
- ▶ pressure
- ▶ redox (ORP)

- ▶ tank level
- ▶ temperature
- ▶ tide and sea state
- ▶ turbidity
- ▶ water velocity
- ▶ weight of snow and ice on a snow pillow
- ▶ wind speed and direction

Sutron also offers general purpose interfaces for making analog and digital measurements via SDI-12.

For more information on SDI-12, go to [WWW.SDI-12.ORG](http://WWW.SDI-12.ORG).

## 18.2 Wiring Guidelines

SDI enables you to connect up to 10 sensors with as many as many as 9 parameters each. The interface is implemented using three wires: data, ground, and +12V. The ground conductor of the SDI interface line should be large enough to keep the voltage drop between the data recorder and the sensor to less than 0.5 volts during the maximum sensor current drain. Failure to observe this specification will cause bad communications and/or bad data. The maximum current used on the +12V line should not exceed 0.5 amps at any time.

## 18.3 Connector

The connector type is not part of the SDI specification. Make sure to connect all three lines: SDI-12 Data, SDI-12 PWR, and GND. Multiple sensors can be connected to a single connector.

## 18.4 Setup of SDI sensors

Each SDI-12 sensor has an address from 0 to 9. This address differentiates one sensor from another. Most sensors are factory default set to address zero (0). If/when interfacing more than one sensor, each sensor must be assigned a unique address. This is normally done by setting dip switches on the sensor or by software commands. Failure to set unique addresses for each sensor will result in failure of the communications interface (i.e. no data logged). Consult the sensor manufacturer's data for information on your particular sensor(s).

When setting up multiple SDI-12 sensors, connect one sensor at a time. Once a new sensor is connected, you must give it a unique address. To do so, either use LinkComm or the command line. Type SDI-12 FIND to detect new sensors. Once a sensor is found, change its address by typing SDI xAy!, where x is the old address, A is A, and y the new address. For example, SDI 0A1! will change the address from 0 to 1.

When getting more than one parameter from a single sensor, be sure to set the measurement schedules the same. When the station finds multiple parameters from a single sensor (same address), it will only issue a measurement of the sensor once, then read each of the parameters from the one measurement.



This is important to ensure that data from one sensor is gathered at the same time and for sensors that have multiple parameters that take a long time to process.

## 18.5 Useful SDI commands

Resetting the address by software (some sensors) is normally done by sending the aAb! command. (a A b !, where a is the current address of the sensor you want to change and b is the address you want to change to, e.g., 0A5! changes the address of sensor 0 to address 5.)

Another useful SDI-12 command is the a! (where a is the address of the sensor, e.g., 3! for sensor at address 3) command. 4! will return an identification string from the sensor at address 4, which includes the SDI version number, vendor's name, sensor model number, sensor version number, and serial number. This is a quick way to see if the sensor is responding properly.

A way to verify data collection (manual data collection) is to issue the aM! command. For example, 7M! would collect data from the sensor at address 7. The sensor will respond with a 5-digit code -- the first digit is the address, the next 3 digits are the required time for measurement in seconds, and the last digit is the number of data values returned. Wait for the number of seconds. Then issue the aD0! (address, D, zero, !) the sensor should respond with one or more data values. You may issue further aD1! ... aDn! till you get all of the data.

If the SDI sensor is version 1.3 (version number can be found out by sending the ?! command; the version is returned as the second and third characters of the response), then make sure to use the CRC measurement commands. These commands work just like normal measurement commands, except that they use an error checking mechanism that minimizes errors. So, instead of 0M!, use 0MC!. Instead of 0M1!, use 0MC1!. This will ensure reliable SDI communication.

## 18.6 SDI Clock Synchronization

Certain Sutron SDI-12 sensors (such as the SDR, RLR, and the CF Bubbler) support a command to set the time of the sensor via SDI-12. The system takes advantage of that feature, and periodically sets the clock of the sensors using an SDI-12 command, ensuring that all devices share a common time.

When recording is enabled, and every 24 hours thereafter, the station performs a time sync with all the Sutron devices that support the XDT! command. The time sync is started by sending an !! command to every SDI-12 device that has been set up. If the device replies favorably to the !! command, an XDT! command is issued to the device. The system then decides whether to sync that device's clock based on the time difference between the system and the device.

This process is automatic and cannot be disabled.

The XDT set time command takes the format

- ▶ aXDTYYYY/MM/DD HH:MM:SS!
  - ▲ a is address

- ▶ XDT is the command to set the date and time
- ▶ YYYY is the year
- ▶ MM is the month (01 to 12)
- ▶ DD is the day of the month (01 to 31)
- ▶ HH is the hour (military time 0 to 23)
- ▶ MM is the minutes
- ▶ SS is the seconds

Example set date time command:

- ▶ 0XDT2017/07/26 11:15:34!

# 19 Modbus

---

Modbus is a communications protocol commonly used in industrial applications. Please see the [WIKIPEDIA ENTRY](#) for more details.

- ▶ The station can be configured as a Modbus server or as a limited Modbus client.
- ▶ In Modbus client mode, the station collects data from Modbus sensors.
- ▶ In Modbus server mode, the station provides sensor data to a Modbus client.

## 19.1.1 The Station as a Modbus Server

The station is able to function as a Modbus server. In this role, the station will respond to requests from a Modbus client, typically providing data that the station has collected from sensors.

The example below illustrates performance as a Modbus server:

- ▶ The station is setup as a Modbus server on RS-485. This involves setting *Modbus RS485 Server Enable to ON*.
- ▶ Measurement M1 is configured to collect data from an SDI-12 sensor. This means that the station collects data from the SDI-12 sensor on a scheduled basis.
- ▶ Periodically, the Modbus client will get the most recent data that was collected by the station from the SDI-12 sensor. This effectively makes the station a bridge between the Modbus client and the SDI-12 sensor.
- ▶ The Modbus client gets that sensor data by reading the station's input registers 1 and 2, combining the result into a 32bit floating point value. Registers 1 and 2 reflect the last reading from measurement M1. Similarly, registers 2 and 3 relate to M2. Please see the section [19.4.1.2 INPUT REGISTERS](#) for details on other registers.

**Please note that if the station is setup as a Modbus server, it will no longer perform any other function on that port.**

This means that if the station is a Modbus server on RS-232, the RS-232 port cannot be used for command line communications. Similarly, if the station is a Modbus server on RS-485, then the station cannot collect sensor data over RS-485.

In server mode, extended Modbus commands allow the downloading of the station log, reading and writing station setup, accessing status information, and more.

Please note that using Modbus server will increase power consumption of the station. When it is a Modbus server, the station is always ready to accept incoming data. RS-232 and RS-485 do not have control lines that can be used to wake the station up, resulting in an power consumption increase of about 8mA @ 12V. Modbus over cell requires that the cell modem be on and listening all the time, which increases power consumption too.

### 19.1.2 The Station as a Modbus Client

The station is capable of operating as a Modbus client. It can collect data from sensors using the Modbus protocol. When setup to collect data from Modbus sensors, the station will periodically issue a client read register message on the data bus. Sensors on the bus act as servers: they will reply to the message, providing 'register values' which translate to sensor readings.

Multiple Modbus sensors may be connected to the RS-485 bus. However, each sensor must be programmed with a unique Device ID. If the sensors do not have unique IDs, they will cause collisions on the data bus, resulting in failures to collect sensor data. The station is NOT capable of changing Device IDs. Please refer to the sensor's documentation for information on how to change their IDs.

Please note that the station does NOT have the ability to write Modbus registers.

## 19.2 Modbus Hardware Interface

There are several interfaces that support Modbus communication:

- ▶ RS-485
- ▶ RS-232
- ▶ Cell modem

The station may be a Modbus client or a Modbus server over RS-485 and over RS-232. The station may only be a Modbus server over the cell modem.

Each interface can be setup independently of the other one. Each interface has its own setup. This means that the station could be a Modbus client on RS-485 and a Modbus server on Cell modem at the same time.

### 19.2.1 Wiring Modbus RS-485

The station has a half-duplex RS-485 interface. That means that the same lines are used for sending and receiving data.

Only two lines need to be connected to use RS-485:

- ▶ RS-485 A
- ▶ RS-485 B

When wiring, connect the Modbus client's RS-485 A line to the station's RS-485 A Line. Do the same for RS-485 B.

### 19.2.2 Wiring Modbus RS-232

When using RS-232 for Modbus communications, only three of the lines in the DB9 connector are necessary:

- ▶ TX
- ▶ RX
- ▶ Ground

The station will assert RTS before sending data out the port in order to key off a radio.

The station also drives DTR whenever Modbus is active.

### 19.2.3 Troubleshooting Modbus

If there are Modbus communications issues over RS-485 or RS-232, there are two potential causes:

- ▶ The setup; Please make sure that the stations' Modbus setup is the same as that of the client. These settings must match: Protocol, Device ID, Baudrate, Parity, and the two Delay settings.
- ▶ Wiring: Try reversing RS-485 A and B.

### 19.2.4 Modbus Server Over the Cell Modem

It is possible to access the station over the internet using Modbus. The station must be equipped with a Cell modem to utilize this feature.

In this scenario, the IP address of the cell modem is used by the Modbus client to access the station. The IP address can be found via LinkComm: it is displayed in the Telemetry tab's Status view.

The station will accept incoming connections using the Listen port setting on the Telemetry tab. The default port is 3001.

Only the TCP/IP Modbus protocol may be used over Cell.

The station may only be a Modbus server over Cell.

## 19.3 Modbus Setup

To setup Modbus operation, please use the Other Setup tab of LinkComm. There are independent settings for Modbus Server over the various ports.

To setup, the station as a Modbus client, in addition to configuring the settings in the Other Setup tab of LinkComm, use the Measurement tab and choose Modbus as the Measurement Type.

Here is a list of general Modbus settings and their defaults:

Setting	Default
Modbus Cell Server Enable	Off
Modbus Rs485 Server Enable	On
Modbus Rs485 Server Device ID	1
Modbus Rs485 Server Delay before Tx	0 ms
Modbus Rs485 Server Delay after Tx	0 ms
Modbus Rs485 Protocol	RTU
Modbus Rs485 BaudRate	19200
Modbus Rs485 Parity	Even

Modbus Rs232 Server Enable	On
Modbus Rs232 Server Device ID	1
Modbus Rs232 Server Delay before Tx	0 ms
Modbus Rs232 Server Delay after Tx	0 ms
Modbus Rs232 Protocol	RTU
Modbus Rs232 BaudRate	19200
Modbus Rs232 Parity	Even

Additionally, if the station is to collect data from Modbus sensors, it needs to have a measurement setup for each Modbus sensor. Below is a list of all the Modbus measurement settings along with their defaults:

Setting	Default
Modbus Port	RS485
Modbus Device Id	1
Modbus Reg Type	Holding
Modbus Reg Number	1
Modbus Value	Short
Modbus MSW	Hi Reg
Modbus Timeout	2 sec
Modbus Retries	3

### 19.3.1 Modbus General Settings

#### 19.3.1.1 Modbus Server Enable

For the station to become a Modbus server over one of the ports, the appropriate setting must be enabled.

Once Modbus Server Enable is turned on any port, LinkComm will no longer be able to access the station over that port. Once enabled, the setting may only be turned off over a different communications port. Here are options that are always available:

- ▶ LinkComm connecting via USB and Wi-Fi
- ▶ Send a setup file via Modbus
- ▶ Change setup using USB thumb drive
- ▶ Sending a text message to the station. The text message should say **MODBUS CELL SLAVE ENABLE = OFF**

#### 19.3.1.2 Modbus Protocol

The Protocol setting affects both Modbus client and Modbus server on RS-485 and RS-232. Modbus over RS-485 and RS-232 allows RTU and ASCII protocols. RTU is the default value. Cell only supports the TCP/IP protocol.

Modbus supports different protocols:

- ▶ RTU (usable on RS-232 and RS-485)

- ▶ ASCII (usable on RS-232 and RS-485)
- ▶ TCP (usable on Cell only)

RTU is the most basic Modbus protocol and is commonly used for directly wired systems. It requires a robust connection as it has stringent timing requirements.

The ASCII protocol is most forgiving of timing issues and will produce the best communication results when communicating over a modem. However, the ASCII protocol also uses the most bandwidth.

The TCP protocol is traditionally used over Ethernet. It takes advantage of the error checking and correction built into TCP/IP.

Please see the [WIKIPEDIA ENTRY](#) for more details on the protocols.

#### 19.3.1.3 *Modbus Server Device ID*

When the station is setup as a Modbus server, this setting is used to uniquely identify the station among the different devices that are on the same bus.

The Device ID is only relevant for RTU and ASCII protocols. It is used to allow multiple Modbus servers to be connected to one Modbus client.

The Device ID is the address that is used by the Modbus client to select which device to communicate with. Each server on the bus must have a unique device ID ranging from 1 – 247. Address '0' is reserved as the broadcast address.

When a Modbus client issues a command, it includes the Device ID in the command. Only the Modbus server with a matching ID is allowed to answer. If multiple servers have the same ID, communication will not work.

Device ID is sometimes referred to as Server Address, Station Address, or Server ID.

#### 19.3.1.4 *Modbus Baud Rate*

Default is 19200 Baud. Care must be taken to make sure the selected speed matches that of the client or there will be communication problems.

This setting affects both Modbus client and Modbus server.

#### 19.3.1.5 *Modbus Parity*

Default is Even. Available choices include Even, Odd and None.

Note: Care must be taken to make sure the selected parity matches that of the client or there will be communication problems.

This setting affects both Modbus client and Modbus server.

#### 19.3.1.6 *Modbus Server Delay before Tx*

Default is 0ms. This identifies the number of milliseconds to wait before starting data transmission. This is useful if the device is connected to a radio requires keying initialization before data transmission.

This is a Modbus server setting only. There is no delay when the station is a Modbus client.

#### 19.3.1.7 *Modbus Server Delay after Tx*

Default is 0ms. This identifies the number of milliseconds to wait after data transmission. This is useful if the device is connected to a radio that requires a hold-off time after data transmission has completed.

**If this value is other than zero, it may cause communications issues!**

This is a Modbus server setting only. There is no delay when the station is a Modbus client.

### 19.3.2 Modbus Measurement Settings

These settings appear on the Measurement tab of LinkComm. To have the station act as a Modbus client, choose Modbus as the Measurement Type.

#### 19.3.2.1 *Modbus Port*

This is a measurement setting that tells the station which port the Modbus sensor is connected to. Options include RS-485 and RS-232.

#### 19.3.2.2 *Modbus Device Id*

Modbus Device Id indicates what sensor to collect data from. For the station to collect data from a Modbus server, the station's Modbus Device Id must match that of the sensor.

This setting should come into play only if there are multiple sensors on the bus.

#### 19.3.2.3 *Modbus Reg Type*

Modbus Reg Type needs to correspond to the type of register that contains the desired sensor data. Options include Coil, Discrete, Holding, and Input. Please check the sensor's documentation for details on registers.

Coil and Discrete register types imply that the station will collect one byte from the sensor and consider the least significant bit of the byte.

#### 19.3.2.4 *Modbus Reg Number*

Modbus Reg Number tells the station which of the sensor's registers to access. These values are unique to the sensor that is connected. Most sensors provide multiple registers which may be read.

#### 19.3.2.5 *Modbus Value*

Modbus Value tells the station how much data to collect and how to interpret it.

- ▶ Short means collect data from one register and interpret them as a 16 bit signed integer.
- ▶ Ushort implies a 16-bit unsigned integer.
- ▶ Int and Uint indicate 32 bit signed and unsigned values respectively; the station will read 2 registers for them.



- ▶ Float is a IEEE 32 bit floating point value.
- ▶ Double is a IEEE 64 bit floating point value.
- ▶ Discrete means that the sensor returns one byte and that the result is based on the least significant bit of the byte.

#### 19.3.2.6 Modbus MSW

For certain Modbus Value (Int, Uint, Float, Double), Modbus MSW determines which register is used to contain the most significant word (MSW) of the tag's value. When set to "Low Reg", the lower register of the register pair is used to contain the MSW.

#### 19.3.2.7 Modbus Timeout

Modbus Timeout is the amount of time in seconds that the station will wait for a reply from the sensor.

#### 19.3.2.8 Modbus Retries

Modbus Retries indicates how many times the station will retry to issue the command to a sensor in case of failures. Please note that some sensors require at least one retry to work at all. For those sensors, the initial command only wakes the sensor up after which the sensor replies to the retry.

## 19.4 Modbus Server Function Codes

The following table identifies the functions that are supported. Each diagnostic counter is cleared when the device is powered up or reset.

Code	Hex	Subcode	Hex
Read Holding Registers	0x03		
Read Input Register	0x04		
Write Single Register	0x06		
Diagnostic	0x08	Return Query Data	0x00
Diagnostic	0x08	Clear Counters	0x0A
Diagnostic	0x08	Return Bus Message Count	0x0B
Diagnostic	0x08	Return Bus Comm Error	0x0C
Diagnostic	0x08	Return Bus Exception Count	0x0D
Diagnostic	0x08	Return Server Message Count	0x0E
Diagnostic	0x08	Return Server Broadcast Count	0x0F
Diagnostic	0x08	Return Bus Char Overrun Count	0x12
Write Multiple Registers	0x10		
Sutron Function Code	0x41	Get Log	GL
Sutron Function Code	0x41	Get File	GF
Sutron Function Code	0x41	Send File	SF

### 19.4.1 Identifying Registers

There are two types of data that can be accessed using the Modbus protocol. These include Holding and Input registers.

#### 19.4.1.1 Holding Registers

Holding registers are reserved for the purpose of setting and getting data such as the date and time and diagnostic counts if the ability to send the above Diagnostic (0x08) command is not available. The following table identifies the holding registers and their locations. Each of these registers is an unsigned 16-bit value (if readings registers using an Xpert, set the data type to ushort).

Data	Register	Valid Data Values
Hour of current time	1001	0 – 23
Minute of current time	1002	0 – 59
Second of current time	1003	0 – 59
Year of current time	1004	> 2000
Month of current date	1005	1 – 12
Day of current month	1006	1 – 31
Recording status	1007	1 means running 0 means stopped
Reset Unit	1008	Write 1 to reset
Modbus Protocol	1009	0 – RTU 1 – ASCII
Force Measurement *	1010	0 – force all active measurements 1-32 force that measurement only
Bus Message Count	1011	Read Only
Bus Comm Error	1012	Read Only
Server Exception Count	1013	Read Only
Server Message Count	1014	Read Only
Broadcast Message Count	1015	Read Only
Char Overrun Count	1016	Read Only

\*Note: When forcing a measurement, be sure to wait the proper amount of time for a measurement to finish before requesting data.

#### 19.4.1.2 Input Registers

Input registers return the last measured data from the device. Ideally these values should be requested on a schedule slightly lagging the measurement schedule on the station. This will ensure data will follow that found in the log. If the last measured data is not acceptable, a live reading can be forced by writing to the Force Measurement (1010) holding register. Care must be taken to allow enough time to pass for taking a measurement before requesting the data.

Since the system works with floating point numbers and Modbus only allows for 16-bit registers, a multiple register read can be used to access the entire reading. The Modbus client device should be configured to treat these reads as a single floating point number. For example, if accessing Last measured via an Xpert, read 1 value of type float starting at register 1. The complete list of registers and their locations are below.

Modbus registers measurement	Last Measured	
	msw	lsw
M1	1	2
M2	3	4
M3	5	6
M4	7	8
M5	9	10
M6	11	12
M7	13	14
M8	15	16
M9	17	18
M10	19	20
M11	21	22
M12	23	24
M13	25	26
M14	27	28
M15	29	30
M16	31	32
..		
M32	63	64
Battery Voltage	901	902
Internal Temp	903	904

M1, M2, .. M32 refer to measurements.

E.g., to read the last measured sensor value for measurement M10, read registers 19 and 20 and combine the result into a single 32 bit IEEE floating point value.

### 19.4.2 Calibrating Measurements by Writing to Modbus Registers

It is possible to write to the station’s Modbus Holding Registers in order to calibrate measurements.

Modbus Holding Registers 1 and 2 will map to measurement M1 and be interpreted as a float (register 1 is MSW, 2 is LSW). Registers 3 and 4 map to M2 in the same way. Please see the table above for a complete register map.

- ▶ Writing to the Modbus Holding Registers will be treated like a measurement calibration.
  - ▶ If the Measurement Type is Manual Entry, writing to the corresponding registers will simply update the measured value to the received value.
  - ▶ The values written to the Registers will be logged and transmitted just like other sensor readings.
- To use this feature, setup the system as a Modbus Server. No further setup is needed.

## 19.5 Sutron Function Codes

This section describes the use of the Sutron function code to get files, send files and, get the log over MODBUS. This only applies when the station is a Modbus server.

The data portion of a packet carrying the Sutron function code (function code 65, or 0x41) contains a subcode and associated parameters to define the particular function to perform. The subcode and its parameters are expressed using ASCII characters. The functions that each sub-code performs are defined to be stateless, and the burden of the transport is on the client station.

The following text defines the subcode functions, parameters, and responses.

### 19.5.1 Get Log Command

The Get Log subcode is used to retrieve log data from the unit. The format of the command is as follows:

#### **GL,logfilename,datetime,recordID,numbytes**

- ▶ The logfilename can be used to return log entries of specific types. The available types are
  - ▶ data
  - ▶ events
  - ▶ all
- ▶ The datetime value must be in the following format: MM/DD/YYYY HH:MM:SS.
- ▶ The numbytes value refers to the number of data bytes from the log entry to include in the response, not the number of bytes to store in the return packet. The station will never return more than 255 data bytes. Since the client station or transport medium may be limited in the number of bytes that can be handled in a single packet, the numbytes value should be sized small enough to allow for header and CRC information, as well as translation to ASCII if that is the selected protocol (the ASCII protocol uses two bytes to represent every data byte). If numbytes is \*, up to 255 bytes will be returned. Regardless of the requested numbytes, only complete log records are returned. Do not set numbytes to less than 64. Ideally, use \* or 255.

The format of the reply is as follows:

#### **GLR,status,recordID,numbytes,data[numbytes,data]**

The value of status can be any of the following values:

Value	Description
0	Ok.
1	File not found.
2	Get beyond file end.
6	Record not found.
7	Command format error

The datetime value in the response message is the datetime of the returned record and, therefore, may be different from the datetime in the GetLog command statement.

The data to the end of the file can be read by leaving datetime at the desired starting point and incrementing recordID until the status indicates record not found. The [numbytes,data] represents an additional record of data if there is room in the message.

Example:

```
command: GL,data,02/07/2007 15:50:00,80,0
reply:   GLR,0,0,38,02/07/2007,15:51:00,VBAT,13.16,Volts,G
        37,10/07/2003,15:51:10,A,10.89,5.2,-25.4
command: GL,data,02/07/2007 15:50:00,80,2
reply:   GLR,0,2,37,02/07/2007,15:54:00,C,10.89,5.2,-25.4,0
```

The GLR response will contain as many log records as can fit into the response.

The numbytes value in the GLR response does not include the comma preceding the data and refers to the number of data bytes from the log that are being returned, not the number of packet bytes used to store the response (which would be twice the data bytes when ASCII protocol is selected).

### 19.5.2 Get File Command

The Get File command is very similar to the get log command.

The format of the Get File command:

**GF,filename,startpos,numbytes**

Filename may only be one of the following:

- ▶ curdata.txt
- ▶ sensors.txt
- ▶ status.txt
- ▶ setup.txt
- ▶ flash disk.txt

startpos indicates the zero-based byte position in the file from which to start the download. When first issuing the GF command, this value should be 0. Once a reply is received from the station, this number should increment by the number of bytes returned by the station.

numbytes indicates how many bytes should be returned. \* should be used to have the station decide how many bytes to return. 255 is the maximum value accepted by the station. If the value provided is too small, the command may fail. To be safe, use 128, 255, or, best of all, \*.

The station will reply to the GF command like so:

**GFR,status,totalbytes,start,numbytes,data**

status will have one of the following values:

Value	Description
0	Ok.
1	File not found.
2	Get beyond file end.
6	Record not found.
7	Command format error

totalbytes will be set to the byte size of the whole file. It is not the number of bytes returned in this retry! The client station should issue repeated GetFile commands until it has received totalbytes amount of data. Retries are the responsibility of the client station. If totalbytes changes in the reply, the file has changed and the get should be restarted. If a reply is missing, the client station must request the data again.

start should be the same value as startpos in the Get File command.

The numbytes value in the GFR response does not include the comma preceding the data and refers to the number of data bytes from the file that are being returned, not the number of packet bytes used to store the response (which would be twice the number of data bytes when ASCII protocol is selected).

data is the data payload. It is the file data requested by the Get File command. There are numbytes bytes of data.

19.5.2.1 *Current data*

Request the file "curdata.txt" and the station will reply with last measured sensor data. The reply is very similar to what is found in LinkComm's Data tab. The format is

**MM/DD/YYYY,HH:MM:SS,Label,Value,Units,Quality**

Each line is terminated by a CR/LF. Date and Time are expressed as in "01/31/2004" and "20:47:52", respectively. Quality is a single character defining the quality of the data where "G" = Good and "B" = Bad

Below is an example:

**M1 BATT, 12.190, 2017/03/16 17:11:10,  
M2 TEMP, 24.00, 2017/03/16 17:11:10,  
M3 MINO, 1032, 2017/03/16 17:11:10,**

Note that if no measurements are enabled, GF commands for sensors.txt and curdata.txt will return errors.

#### 19.5.2.2 Status information

If the file "status.txt" is asked for, the data returned will be similar to what LinkComm shows on the Main Status and on Telemetry Status.

#### 19.5.2.3 Sensor data

Access recent measurements and setup details by asking for the file "sensors.txt". The data in the file will describe the measurement setup along with the most recent readings. The data mimic's Sutron 9210's sensor view. Tab characters are used to denote column breaks. Each line is terminated by a CR/LF.

```
BATT Battery = 0.000 V; Q = B  
TEMP Internal Temp = 0.00 C; Q = B  
MINO Manual Entry = 0; Q = B
```

Note that if no measurements are enabled, GF commands for sensors.txt and curdata.txt will return errors.

#### 19.5.2.4 Setup

The station setup may be read by asking for "setup.txt". The data returned will be exactly the same as that of a saved LinkComm setup file.

#### 19.5.2.5 Flash disk

The system can also provide data for the file "flash disk.txt". The data returned mimics the response of a file system to a directory command. It returns a list of the files it supports via the Modbus GF command along with their size and date.

```
setup.txt,5447,03/16/2017 17:32:41  
curdata.txt,107,03/16/2017 17:32:41  
sensors.txt,102,03/16/2017 17:32:41  
status.txt,512,03/16/2017 17:32:41
```

Due to a limitation, the size of setup.txt is always 512 bytes.

The date of the files will always be set to the station's current time.

### 19.5.3 Send File

The Send File subcode is used to send a file to the station. The station will only accept one file: "setup.txt". The procedure is used to change the station setup. The file needs to contain setup data. The setup data should be the same as in the setup file saved by LinkComm.

```
SF,filename,bytepos,numbytes,data
```

The filename must be setup.txt.

bytepos is the position of the first byte in the data stream. It is zero based. The first packet with the data should have 0 as the bytepos.

numbytes is the number of data bytes in the payload. For Modbus over RS-485, this number must not be greater than 48.

data should contain actual setup data. Example:

**STATION NAME = HAPPY CREEK**  
**M1 MEAS INTERVAL = 00:00:30**

The format of the reply is as follows:

**SFR,status,bytepos,numbytes**

The value of status can be any of the following values:

Value	Description
0	Ok.
1	File not found.
3	Write Failed.
4	Gap at end of file
7	Command format error



## 20 Scripts

---

For further customization, XLink supports scripts written in the Python programming language. Not all XLink models have this feature. These scripts may be used to

- ▶ Collect data from sensors that are otherwise unsupported, such as an RS-232 sensor
- ▶ Do custom measurement processing
- ▶ Perform control operations
- ▶ Allow for custom transmission formatting
- ▶ And much more...

This manual provides an overview on Python scripts and how they integrate into station setup. Further documentation is located on the Sutron website. It includes the Python API, development environment setup, Python resources, additional libraries, and example code.

- ▶ [HTTP://WWW.SUTRON.COM/MICROPYTHON/HTML/INDEX.HTML](http://www.sutron.com/micropython/html/index.html)

To load a script file into the station, please read the section [20.4-SCRIPTS MANAGEMENT](#). Please note that

**Every script file must include the `sl3` module. To the top of each script, add `from sl3 import *`**

The station handles Python scripts in conjunction with the standard setup. There are three main interface points:

- ▶ Measurements, via the *Use Script* and *Script Function* settings.
- ▶ Transmissions, via the *Custom Script Format* and *Format Function* settings.
- ▶ Script Tasks, which are a new concept; each task runs a script at the customer designated time.

### 20.1 Measurements and Scripts

Measurement scripts work in the following fashion:

- ▶ A value is read from the sensor using the standard setup
- ▶ The sensor value is further processed by the script

This is similar to how measurement equations work.

Scripts do not have direct access to analog and digital sensor inputs. Instead, measurements need to be setup to collect data from those sensors. Python scripts then do processing on the measurement results.

Two settings are relevant when using measurements and scripts:

- ▶ *Use Script*
- ▶ *Script Function*

To use the script, enable *Use Script* and set *Script Function* to the name of the Python routine that should be invoked (in the example below, that would be *twelve\_more*).

### 20.1.1 Twelve More Measurement Script Example

Here is an example of a measurement script:

```
@MEASUREMENT
def twelve_more(inval):
    """returns 12+input"""
    return 12 + inval
```

The example script above adds twelve to the result of the sensor reading in order to provide a final measurement result.

Let us suppose that a measurement were setup as a battery voltage reading. Let us suppose that the current battery voltage is 13.5. If the script *twelve\_more* were associated with that measurement, the station would do the following:

- ▶ Make a battery voltage reading (13.5V)
- ▶ Pass the value 13.5 to script function *twelve\_more*
- ▶ *twelve\_more* would run, adding 12 to 13.5 and returning a value of 25.5
- ▶ The final measurement result would be 25.5.

### 20.1.2 Rules for Measurement Scripts

These rules must be followed when writing a script that will be referenced by the measurement:

- ▶ The @MEASUREMENT decorator must be on the line preceding the Python function. The decorator is case sensitive.
- ▶ The measurement function must take in one floating point type parameter, and it must return a float parameter.
- ▶ The parameter passed to the function is the result of the sensor reading.
- ▶ The parameter returned by the function is the final result of the measurement.
- ▶ The function may call into any other functions in the script. Those other functions do not need to have the @MEASUREMENT decorator.

### 20.1.3 Minutes of Daylight Measurement Script Example

A typical usage scenario for a measurement script is illustrated by the daylight counter. The goal of the measurement is to count the number of minutes of daylight. A single measurement is setup with the following details:

```
Measurement M1 daylight
  Active = On
  Label = daylight
  Meas Type = Analog
  Meas Interval = 00:01:00
  Use Script = On
  Script Function = minutes_of_daylight
```

And here is the script used

```
@MEASUREMENT
def minutes_of_daylight(pv):
    """
    This program counts minutes of daylight in a 24 hour period.
    The following measurement setup configuration is assumed:
    Analog type for PV reading, measurement interval is one minute

    :param pv: analog reading from PV sensor
    :return: number of daylight minutes so far
    """
    global m_daylight

    if pv > 0.8:
        """ greater than 0.8 indicates daylight """
        m_daylight += 1.0

    if ascii_time_hms(time_scheduled()) == "00:00:00":
        """ at midnight, reset the counter """
        m_daylight = 0.0

    return m_daylight
```

In the example above, every time measurement M1 is made, it will first collect a reading from the analog sensor. It will then feed that reading to the *minutes\_of\_daylight* function which will produce the final result *m\_daylight*. That final result gets logged and transmitted.

#### 20.1.4 Dew Point Measurement Script Example

Dew point is computed by putting air temperature and relative humidity readings through an equation. The dew point example uses a total of three measurements:

- ▶ One measurement is setup to measure air temperature. It may be any type of sensor, but it must be labeled as "AT".
- ▶ A second measurement will interface to a relative humidity sensor. Again, this sensor may be of any type as long as it produces a relative humidity reading. It needs to be labeled "RH".
- ▶ The last measurement computes dew point. This one will use a script. The measurement type used is not relevant as the sensor readings come from the other two measurements.
  - ▶ The **optimal measurement type to use is Manual Entry because it makes no sensor reading.**
- ▶ All three measurements should be scheduled at the same time to produce an accurate dew point result.
- ▶ AT and RH do not have to be logged for this setup to work.

Here is what the station will do with this setup:

- ▶ Measure AT and RH. These are standard measurements.
- ▶ Run the script for the dew point computation, using the AT and RH values just measured.
- ▶ Produce a dewpoint result.

This is the dew point script:

```
@MEASUREMENT
def dew_point(inval):
    """
    Computes dew point based on relative humidity and air
    temperature.
    It is assumed that two other measurements have been setup, one
    called AT and another called RH.
    This script should be associated with a third measurement that
    is setup as a Manual Entry.
    Manual Entry is used because this measurement is based on the
    inputs of two other sensors rather than the
    input associated with this measurement.

    :param inval: this value is ignored
    :return: dew point
    :rtype: float
    """
    from math import log10

    # retrieve relative humidity from another measurement which
    # must be labeled RH
    rh = measure("RH").value

    # retrieve temperature from meas labeled AT
    at = measure("AT").value

    # compute dew point
    dp = 0.057906 * (log10(rh/100) / 1.1805) + (at / (at+238.3))
    dp = dp * 238.3 / (1 - dp)

    return dp
```

## 20.2 Transmission Formatting and Scripts

Scripts may be used to alter the data transmitted by the station. There are several standard transmission formats including SHEF and Pseudobinary. With the use of scripts, other formats may be achieved.

The relevant settings are *Custom Script Format* and *Format Function*.

When setup to use formatting scripts, the station will go through this flow:

- ▶ Format the transmission data in a standard way. If SHEF is the chosen transmission format, then the transmission will be formatted into SHEF. This is identical to what the station does when there is no formatting script.
- ▶ The formatting script function is invoked.
- ▶ The standard formatted transmission data is provided to the script function as a parameter.
- ▶ The script may perform any action on the provided transmission data. It may simply append additional data. Or it may completely disregard the provided transmission data and create a completely new set of data.
- ▶ The script ends by returning the new set of transmission data.

### 20.2.1 Append Info Script Formatting Example

Here is the transmission data with a standard SHEF format, without scripts:

```
:AT 0 #1 29.50 29.50 :RH 0 #1 65.00 65.00 :DP 0 #1 26.77 26.77
```

The goal of the script is to append “Little Creek A21938” to that transmission format. The code is very simple:

```
@TXFORMAT
def append_info(standard):
    """appends information to tx"""
    return standard + " Little Creek A21938"
```

Once the transmission is setup to use the script above (by enabling *Custom Script Format* and setting *Format Function* to *append\_info*, the transmission data would become

```
:AT 0 #1 29.50 29.50 :RH 0 #1 65.00 65.00 :DP 0 #1 26.77 26.77 Little Creek
A21938
```

### 20.2.2 Rules for Transmission Formatting Scripts

These rules must be followed when writing a script that will be used for transmission formatting:

- ▶ The @TXFORMAT decorator must be on the line preceding the Python function. The decorator is case sensitive.
- ▶ The function takes in one parameter: it is a string which is the result of a standard tx format (e.g., SHEF).
- ▶ The function returns one parameter: a string containing the new transmission data.
- ▶ The function may call into any other functions in the script file. Those other functions do not need to have the @TXFORMAT decorator.

## 20.3 Script Tasks

Script tasks are a bit like measurements and telemetry. Each script task has its own independent setup, and each script task runs on its own schedule.

Every script task is associated with its own Python function. When the script task runs, it executes the function.

Script tasks can be setup to run on a schedule or to trigger when a certain event happens. Please see the *Trigger* setting below.

### 20.3.1 Script Task Setup

- ▶ *Active*
  - ▶ Just like the measurement field, this one indicates whether the script task will ever run.
- ▶ *Label*
  - ▶ This is a customer given name to the script task for easy identification.
- ▶ *Script Function*

- ▶ What script function to execute when the script is triggered.
- ▶ *Trigger:*
  - ▶ This field determines when the script should run. Options are
    - ▶ *Scheduled*
      - ▶ Script task will run on a schedule, just like a measurement. The schedule is based on the settings *Scheduled Interval and Scheduled Time*. Only happens if recording is on.
    - ▶ *Bootup*
      - ▶ Script will run when the system turns on. It does not matter if recording is on; script will run at bootup.
    - ▶ *Digital 1*
    - ▶ *Digital 2*
      - ▶ Script will trigger when the appropriate digital input changes. System must be recording.
    - ▶ *Alarm In Only*
    - ▶ *Alarm In And Out*
    - ▶ *Alarm Out Only*
      - ▶ These triggers are associated with alarms; they only happen if recording is on.
    - ▶ *Recording On*
    - ▶ *Recording Off*
      - ▶ Script runs when recording is turned on or off.
    - ▶ *On User Connect*
      - ▶ This happens whenever the customer connects to the station via Wi-Fi, RS-232, USB cable, Cell Modem (SMS and TCP/IP), Iridium Message, Front Panel Button Press
      - ▶ This trigger will never happen more frequently than once a minute. System does not need to be recording.
    - ▶ *On Button press*
      - ▶ Whenever the front panel button is pressed, the script will run, regardless of whether the system is recording. Please note that *On User Connect* also happens when the button is pressed.

**Do not hold down the button for more than 5 seconds – the system will reboot if you do!**

  - ▶ *USB Drive Connect*
    - ▶ Script will start execution a short while after a USB flash drive is inserted. The system will first download the log and diagnostics to the USB flash drive (see [7.15 USB THUMB DRIVE \(FLASH DRIVE\) OPERATION](#)). Once those operations complete, the script will be triggered. Once the script completes, the USB drive will be dismantled for safe removal.
  - ▶ *RS232 Connect DSR*
    - ▶ Script executes once the DSR line of the RS232 port is asserted.
  - ▶ *System Running*
    - ▶ This trigger is for scripts that need to run while recording is on.
    - ▶ If a system boots up and recording is already on, the script would trigger.
    - ▶ Additionally, if recording was off and gets turned on, the script would trigger.

### 20.3.2 Rules for Script Task Functions

These rules must be followed when writing a script task function:

- ▶ The @TASK decorator must be on the line preceding the Python function. The decorator is case sensitive.
- ▶ The function does not take in any parameters.
- ▶ The functions does not return any parameters.
- ▶ The function may call into any other functions in the script. Those other functions do not need to have the @TASK decorator.

### 20.3.3 RS-232 Output Script Example

The following example uses a script task to send data out the RS-232 port. The example will read the last value of measurement M1 and output it on the RS-232 port. It is expected that the script will run on a schedule. Such a script could be used to drive a RS-232 display or to pass data to another logger.

```
@TASK
def rs232_last_meas():
    with serial.Serial("RS232", 9600) as output:
        output.write(str(measure(1, READING_LAST)) + "\r\n")
        output.flush()
```

### 20.3.4 Setup Change Script Example

This script increases the measurement and transmission intervals, which results in more frequent data collection and transmissions. It is meant to be run when the system goes into alarm. That means the Script Task's *Trigger* should be set to *Alarm In Only*.

```
@TASK
def alarm_in_setup_change():
    setup_write("!M1 meas interval", "00:01:00")
    setup_write("!M2 meas interval", "00:01:00")
    setup_write("!TX3 scheduled interval", "00:05:00")
```

It is expected that a second script be setup to trigger when the system goes out of alarm; it would restore the measurement and transmission intervals.

```
@TASK
def alarm_out_setup_change():
    setup_write("!M1 meas interval", "00:10:00")
    setup_write("!M2 meas interval", "00:10:00")
    setup_write("!TX3 scheduled interval", "01:00:00")
```

### 20.3.5 Trigger Sampler Script Example

This script task has the job of triggering a sampler once certain conditions are met. It will write a log entry every time it triggers. It is expected that the script be run on a schedule.

```
@TASK
def trigger_sampler():
    """Checks last readings of M1 and M2. If readings meet
    conditions, sampler is triggered via a digital output"""

    if (measure(1).value > 32.5):
        if (measure(2).value < 13.9):
            # trigger sampler by pulsing output for 500ms
            output_control('OUTPUT1', True)
            utime.sleep(0.5)
            output_control('OUTPUT1', False)

            # write a log entry
            reading = Reading(label="Triggered", time=utime.time())
            reading.write_log()
```

## 20.4 Scripts Management

Please use LinkComm to send a new script file to the station. LinkComm's Script tab provides all the needed features to manage the script file.

**Please note that the station holds only one script file. That file may have any number of functions.**

**Every script file must include the `sl3` module. To the top of each script, add `from sl3 import *`**

The traditional workflow to setup scripts in:

- ▶ Run LinkComm and connect to the station
- ▶ Go to LinkComm's Script tab
  - ▶ Open an existing script file or paste in the script
  - ▶ Verify that the expected functions are listed by LinkComm
  - ▶ Press the Test Script button and verify the script works
- ▶ Setup a measurement that will use the script:
  - ▶ Go to the measurement tab
  - ▶ Proceed to setup the measurement(s) to interface to the sensors
  - ▶ Enable Measurement setting *Use Script*
  - ▶ Set Measurement setting *Script Function* to one of the provided script functions. LinkComm will automatically list all compatible functions found in the script file.
  - ▶ Send setup to the unit
  - ▶ Press the Force button to verify that the measurement works as expected.
- ▶ Setup a transmission that will use custom formatting:
  - ▶ Go to the telemetry tab
  - ▶ Setup the transmission
  - ▶ Enable Custom Script Format
  - ▶ Choose the appropriate *Script Format Function*. LinkComm will automatically list all compatible functions found in the script file.



- ▶ Send setup to the station.
- ▶ Press the Show Tx Data button to verify that the formatting works as expected.
- ▶ Setup script tasks:
  - ▶ Go to the script tab
  - ▶ Select S1 (or another script task) on the left side
  - ▶ Make the script *Active*
  - ▶ Choose the appropriate *Script Function*. LinkComm will automatically list all compatible functions found in the script file.
  - ▶ Choose when the script should run via the *Trigger* setting.
  - ▶ Send setup to the station
  - ▶ Press the Test Script button to verify the script does what it should.
- ▶ Make sure the setup is in sync with the station and start recording

### 20.4.1 Saving Scripts and Setups Together

Because setups and scripts work together, it makes sense to associate the setup file, and the script file together.

When LinkComm’s Import Setup feature is used, if the chosen setup uses scripts, LinkComm will prompt for the script file. When the Export Setup feature is used, both the setup and the script are saved.

If the station setup is prepared, loading a script file into the station is easy:

- ▶ Run LinkComm
- ▶ Connect to the station
- ▶ Choose Import Setup from the Menu
- ▶ Choose the setup file
- ▶ Choose the script file
- ▶ Send setup

## 20.5 LinkComm Command Line Options

LinkComm provides means of integrating into a development environment. This makes it possible to send and test scripts to the station directly from the development environment. There are detailed instructions on how to integrate into PyCharm on the web:

- ▶ [HTTP://WWW.SUTRON.COM/MICROPYTHON/HTML/INDEX.HTML](http://www.sutron.com/micropython/html/index.html)

The following Python-related command line options are supported by LinkComm:

Option	Description
--scripttest <file>	Load and test script with the given file path
--scriptsave	Command station to save current script
--station <name>	Connect to station <name>

<code>--wifi</code>	Connect using Wi-Fi
<code>--usb</code>	Connect to first found USB device
<code>--usbid &lt;device-id&gt;</code>	Connect to specified USB <device-id>
<code>--serial &lt;port&gt;</code>	Connect using serial <port>, e.g., COM1, COM2, etc.

Either “`--scripttest <file>`” or “`--scriptsave`” must be specified, telling LinkComm what action to take.

Example usage in PyCharm:

Example	Description
<code>--scripttest \$FilePath\$</code>	Load and test \$FilePath\$ in “New Station”, using current connection settings
<code>--scriptsave</code>	Save script in “New Station”, using current connection settings
<code>--scripttest \$FilePath\$</code> <code>--station EC1200</code>	Load and test \$FilePath\$ in station named “EC1200”, using current connection settings
<code>--scripttest \$FilePath\$</code> <code>--wifi</code>	Load and test \$FilePath\$ in “New Station”, using Wi-Fi connection
<code>--scripttest \$FilePath\$</code> <code>--usb</code>	Load and test \$FilePath\$ in “New Station”, using first found USB device
<code>--scripttest \$FilePath\$</code> <code>--station “EC1200” --wifi</code>	Load and test \$FilePath\$ in station named “EC1200”, using Wi-Fi connection (updates station’s connection settings to Wi-Fi)

# 21 Appendix A – Specifications

XLINK 100/500 - SPECIFICATIONS @ 25°C and 12V input unless otherwise noted

*Specifications subject to change without notice*

GENERAL INFORMATION	
Dimensions XLink 500-1, XLink 100-1 NEMA-4	Inches: 4.5x6.2x1.6 (cm:11.4x15.8x4.1) Inches:7.3x9.5x5.2 (cm:18.5x24.2x13.2)
Weight XLink500-1	1 lbs. (0.5 Kg)
IP rating	IP41 (XLink)
	IP66 (XLink variants with NEMA enclosure)
Operating temperature	-40° C to +70° C ( -40° F to +158° F)
Humidity	Maximum relative humidity 80% for temperatures up to 31 °C decreasing linearly to 50% relative humidity at 40 °C")
Compliance	CE, FCC, ISED
Wire Gauge	Power Inputs: 12-18 AWG
	Terminal Block Inputs: 16-24 AWG
	Earth Ground: 4-10 AWG
	<i>Wires should have an operational temperature range of -40C to +70C or better</i>
POWER REQUIREMENTS	
Input Voltage	9-20 Volts DC 10 -16 V for SDI-12 sensor support Reverse power protected
Quiescent Power Consumption	< 1 mA typical @ 12.5V
Means of Protection	Class III
SDI-12 (Dedicated Interface)	
Compliance	V1.3 data recorder
Power Supplied	500mA, short-circuit protected
ANALOG - SINGLE ENDED (XLink 500 only)	
Number of inputs	2
Range*	0-5V
Accuracy @ 25°C	0.04% typ. FS
Resolution	0.3 µV



ANALOG - DIFFERENTIAL (XLink 500 only)	
Number of Inputs	2
Range*	± 39mV, ± 312mV, ± 2.5V
Accuracy @ 25°C	0.04% typ. FS over 2.5V
Resolution	0.3 µV @ ± 2.5V scale
ANALOG - 4-20 mA (XLink 500 only)	
Number of inputs	1
Range	0-22mA
Accuracy @ 25°C	0.14% FS
Load	Internal 200 Ohms
Digital Inputs/Outputs	
Number of inputs	2
Input type	0-15 V, optional low-level input Status, counter, frequency
Max input frequency	10KHz, optional debouncing, internal pull
Number of outputs	1
Output types	On/off/pulse
Other Inputs/Outputs	
Precision analog reference (XLink 500 only)	2 terminals, 2.5V, 10.0 mA (total)
Switch 12V	1A, 1 port, overload protected
Protected 12V (XLink 500 only)	0.75 A, 1 port
RS-485	1 port; SDI-12, MODBUS, custom communications with Python
RS-232	DB9; terminal interface, user interface, MODBUS, custom communications with Python
USB Device (Micro B)	1 port; PC/MAC communication using Sutron's LinkComm
USB Host (Type A)	1 port; setup, firmware update, log download using a USB flash drive
<p><i>NOTE: Sutron RECOMMENDS installing XLINK500-1 or XLINK100-1 in a NEMA-4 enclosure for all applications requiring outdoor exposure. Sutron recommends the internally mounted lightning protection kit 6661-1353-1 for the -1E or -1C models or an externally mounted lightning protection module such as the Sutron 8111-1113-1 to protect the telemetry RF output.</i></p> <p><i>*Nominal. Guaranteed Analog Input Range Over Temperature Is 0-4.98 V, ± 2.49 V, ± 311 mV, ± 38.9 mV. (Preliminary)</i></p>	





## 22 Appendix B – Sutron Customer Service Policy

---

Dear Customer:

Thank you for making the important decision to purchase Sutron equipment. All Sutron equipment is manufactured and tested to the highest quality standards as set by Sutron's Quality Assurance Department. Our Customer Service Representatives have years of experience with equipment, systems, and services. They are electronic technicians with field and applications experience, not just with a technical background.

### **Customer Phone Support**

Customer Service Representatives routinely handle a wide variety of questions every day. If questions arise, please feel free to **contact** me or one of the Customer Service Representatives. We are available from 8:00 am to 5:00 pm Monday through Friday and will be happy to take your call.

We can answer most sensor and interface questions on the first call. If we cannot quickly answer a question on an interface, we will work with you until we find a solution.

Sometimes a problem is application related. Although we pride ourselves on handling 95% of application related questions over the phone, we maintain constant contact with our Integrated Systems Division and Engineering Division for additional assistance.

### **Introductory Training**

Training is an important part of the Sutron Customer Service philosophy. The Sutron training policy is simple--If you buy Sutron equipment, you get Sutron training! Without the proper training, you cannot take advantage of the benefits and advantages that Sutron equipment provides. We often supply on-site introductory training at your facility for no charge. You provide the classroom, students, equipment, and coffee--we'll provide the instructor.

### **On-Site Visits**

Of course, not all problems can be fixed over the phone. Sometimes a customer needs an on-site technician to identify site related problems or troubleshoot a network. Sutron can provide these services at a reasonable cost. Call for details. If you would like to learn more about Sutron products email [sales@sutron.com](mailto:sales@sutron.com)

Thanks again for your order,

Paul Delisi

Customer Service Manager

Sutron Corporation

## 23 Appendix C – Commercial Warranty

---

### 23.1 Sutron Manufactured Equipment

THE SUTRON CORPORATION WARRANTS that the equipment manufactured by its manufacturing division shall conform to applicable specifications and shall remain free from defects in workmanship and material for a period ending two years from the date of shipment from Sutron's plant.

Sutron's obligation under this Warranty shall be limited to repair at the factory (22400 Davis Drive, Sterling, VA 20164), or at its option, replacement of defective product. In no event shall Sutron be responsible for incidental or consequential damages, whether or not foreseeable or whether or not Sutron has knowledge of the possibility of such damages. This warranty shall not apply to products that have been damaged through negligence, accident, misuse, or acts of nature such as floods, fires, earthquakes, lightning strikes, etc.

Sutron's liability, whether in contract or in tort, arising out of warranties or representations, instructions or defects from any cause, shall be limited exclusively to repair or replacement parts under the aforesaid conditions.

Sutron requires the return of the defective electronic products or parts to the factory to establish claim under this warranty. The customer shall prepay transportation charges to the factory. Sutron shall pay transportation for the return of the repaired equipment to the customer when the validity of the damage claim has been established. Otherwise, Sutron will prepay shipment and bill the customer. All shipments shall be accomplished by best-way surface freight. Sutron shall in no event assume any responsibility for repairs or alterations made other than by Sutron. Any products repaired or replaced under this warranty will be warranted for the balance of the warranty period or for a period of 90 days from the repair shipment date, whichever is greater. Products repaired at cost will be warranted for 90 days from the date of shipment.

### 23.2 Non-Sutron Manufactured Equipment

The above Warranty applies only to products manufactured by Sutron. Equipment provided, but not manufactured by Sutron, is warranted and will be repaired to the extent of and according to the current terms and conditions of the respective equipment manufacturers.



## 23.3 Repair and Return Policy

Sutron maintains a repair department at the factory, 22400 Davis Drive, Sterling, VA 20164. Turnaround time normally ranges from 10-30 days after Sutron receives equipment for repair. **Call Customer Service at (703) 406-2800 for a Return Material Authorization (RMA) number.** Return the defective equipment to the factory, transportation charges paid.

### Extended Warranty and On-Site Maintenance

Extended warranty and on-site maintenance contracts are available. Price quotations may be obtained from Sutron customer service representatives.



## 24 Appendix E – Approvals and Certifications

---

### 24.1 CE

Declaration of Conformity (P/N: 9151-0001) can be obtained by contacting OTT HydroMet Corporation.

### 24.2 Wi-Fi Module

Contains FCC ID: OA3RN1723

IC ID: 7693A-RN1723

This device complies with Part 15 of the FCC Rules. Operation is subject to the following two conditions: (1) this device may not cause harmful interference, and (2) this device must accept any interference received, including interference that may cause undesired operation.

This equipment has been tested and found to comply with the limits for a Class A digital device, pursuant to part 15 of the FCC Rules. These limits are designed to provide reasonable protection against harmful interference when the equipment is operated in a commercial environment. This equipment generates, uses, and can radiate radio frequency energy and, if not installed and used in accordance with the instruction manual, may cause harmful interference to radio communications. Operation of this equipment in a residential area is likely to cause harmful interference in which case the user will be required to correct the interference at his own expense.

Under Industry Canada regulations, this radio transmitter may only operate using an antenna of a type and maximum (or lesser) gain approved for the transmitter by Industry Canada. To reduce potential radio interference to other users, the antenna type and its gain should be so chosen that the equivalent isotropically radiated power (e.i.r.p.) is not more than that necessary for successful communication.

Conformément à la réglementation d'Industrie Canada, le présent émetteur radio peut fonctionner avec une antenne d'un type et d'un gain maximal (ou inférieur) approuvé pour l'émetteur par Industrie Canada. Dans le but de réduire les risques de brouillage radioélectrique à l'intention des autres utilisateurs, il faut choisir le type d'antenne et son gain de sorte que la puissance isotrope rayonnée équivalente (p.i.r.e.) ne dépasse pas l'intensité nécessaire à l'établissement d'une communication satisfaisante.

## 24.3 IRIDIUM

Regulatory Approvals	Radio Tests	Identification
CE	ETSI EN 301 441 V1.1.1 (2000-05)	N/A
FCC	FCC CFR47 parts 2(2013), 15B (2013), & 25 (2013)	Q639603N
Industry Canada	Industry Canada RSS170 Issue 2, March, 2011 Industry Canada RSS-GEN Issue 3, December, 2010	4629A-9603N

### FCC Warning Statement

- ▶ This device complies with Part 15 of the FCC Rules. Operation is subject to the following two conditions:
  1. This device may not cause harmful interference, and
  2. This device must accept any interference received, including interference that may cause undesired operation.
  
- ▶ This equipment complies with FCC radiation exposure limits set forth for an uncontrolled environment. End users must follow the specific operating instructions for satisfying RF exposure compliance. This transmitter must not be co-located or operating in conjunction with any other antenna or transmitter that is not preapproved.
  
- ▶ Changes or modifications not expressly approved by the party responsible for compliance could void the user's authority to operate the equipment.

### Industry Canada Warning Statement

Under Industry Canada regulations, this radio transmitter may only operate using an antenna of a type and maximum (or lesser) gain approved for the transmitter by Industry Canada.

To reduce potential radio interference to other users, the antenna type and its gain should be so chosen that the equivalent isotropically radiated power (e.i.r.p.) is not more than that necessary for successful communication.

This device complies with Industry Canada license-exempt RSS standard(s). Operation is subject to the following two conditions: (1) this device may not cause interference, and (2) this device must accept any interference, including interference that may cause undesired operation of the device.

### R&TTE Statement

Iridium communications Inc. hereby declares that the 9603N is in compliance with the essential requirements and other relevant provisions of directive 1999/5/EC.

## 24.4 Cellular Compliance Information

Cellular Version	Description	Radio	FCC ID	IC ID
<b>CELLULAR-MOD-1</b>	Verizon LTE modem	NL-SW-LTE-TSVG	RI7LE910SV	5131A-LE910SV
<b>CELLULAR-MOD-3</b>	EU LTE modem	NL-SW-LTE-TC4EU	--	--
<b>CELLULAR-MOD-5</b>	HSPA+ Global	NL-SW-HSPA	RI7HE910	5131A-HE910
<b>CELLULAR-MOD-6</b>	LTE Global	NL-SW-LTE-QBG95	XMR201910BG95M3	8914800005976205013
<b>CELLULAR-MOD-7</b>	North America LTE	NL-SW-LTE-TC4NAG	RI7LE910CXNF	5131A-LE910CXNF

The cellular option card can be found in the option card slot. To remove the modem card, unscrew the 2 screws and pull on the SMA connector. The FCC ID is located on the modem serial label on the back side.



### CAN ICES-3 (B) / NMB-3 (B)

This Class B digital apparatus complies with Canadian ICES-003.

### FCC Warning Statement

This device complies with Part 15 of the FCC Rules and Industry Canada license-exempt RSS standard(s). Operation is subject to the following two conditions:

3. This device may not cause interference, and
4. This device must accept any interference, including interference that may cause undesired operation of the device.

While these modems with our cellular option cards will work with other antennas from other manufacturers, we recommend the following antennas as they have been tested with our products:

Manufacturer	Part Number
Laird	TRA6927M3
Pulse Larsen	SB698MAXX

This transmitter must not be co-located or operating in conjunction with any other antenna or transmitter that is not preapproved. The antenna should be installed and operated with minimum distance of 27 cm between the radiator and your body.

### FCC Class A digital device notice

This equipment has been tested and found to comply with the limits for a Class A digital device, pursuant to part 15 of the FCC Rules. These limits are designed to provide reasonable protection against harmful interference when the equipment is operated in a commercial environment. This equipment generates, uses, and can radiate radio frequency energy and, if not installed and used in accordance with the instruction manual, may cause harmful interference to radio communications. Operation of this equipment in a residential area is likely to cause harmful interference in which case the user will be required to correct the interference at his own expense.

## 24.5 Notice

```
/*
Base64 encoding/decoding (RFC1341)
Copyright (c) 2005-2011, Jouni Malinen <jw1.fi>
License
-----

This software may be distributed, used, and modified under the terms of
BSD license:

Redistribution and use in source and binary forms, with or without
modification, are permitted provided that the following conditions are
met:

1. Redistributions of source code must retain the above copyright
notice, this list of conditions and the following disclaimer.

2. Redistributions in binary form must reproduce the above copyright
notice, this list of conditions and the following disclaimer in the
documentation and/or other materials provided with the distribution.

3. Neither the name(s) of the above-listed copyright holder(s) nor the
names of its contributors may be used to endorse or promote products
derived from this software without specific prior written permission.

THIS SOFTWARE IS PROVIDED BY THE COPYRIGHT HOLDERS AND CONTRIBUTORS
"AS IS" AND ANY EXPRESS OR IMPLIED WARRANTIES, INCLUDING, BUT NOT
LIMITED TO, THE IMPLIED WARRANTIES OF MERCHANTABILITY AND FITNESS FOR
A PARTICULAR PURPOSE ARE DISCLAIMED. IN NO EVENT SHALL THE COPYRIGHT
OWNER OR CONTRIBUTORS BE LIABLE FOR ANY DIRECT, INDIRECT, INCIDENTAL,
SPECIAL, EXEMPLARY, OR CONSEQUENTIAL DAMAGES (INCLUDING, BUT NOT
LIMITED TO, PROCUREMENT OF SUBSTITUTE GOODS OR SERVICES; LOSS OF USE,
DATA, OR PROFITS; OR BUSINESS INTERRUPTION) HOWEVER CAUSED AND ON ANY
THEORY OF LIABILITY, WHETHER IN CONTRACT, STRICT LIABILITY, OR TORT
(INCLUDING NEGLIGENCE OR OTHERWISE) ARISING IN ANY WAY OUT OF THE USE
OF THIS SOFTWARE, EVEN IF ADVISED OF THE POSSIBILITY OF SUCH DAMAGE.
*/
```

## 25 Appendix F - SIM Card Installation and Removal Instructions

Following section details the instructions involved in installation and removal of SIM cards for Sutron Cell modems

1. Sutron Cell modems support only “micro SIM” size.
2. Care must be exercised while handling the sim card and modem.
  - 2.1. Sim card should be handled using clean hands to avoid any dirt or smudges being left on the SIM card.
  - 2.2. Modem should be handled in a clean environment to prevent any dirt accumulation or ESD damage.
3. To install the SIM card,
  - 3.1. Remove the modem card from carrier board carefully. If modem is installed, remove power, and carefully pull the cellular board out.

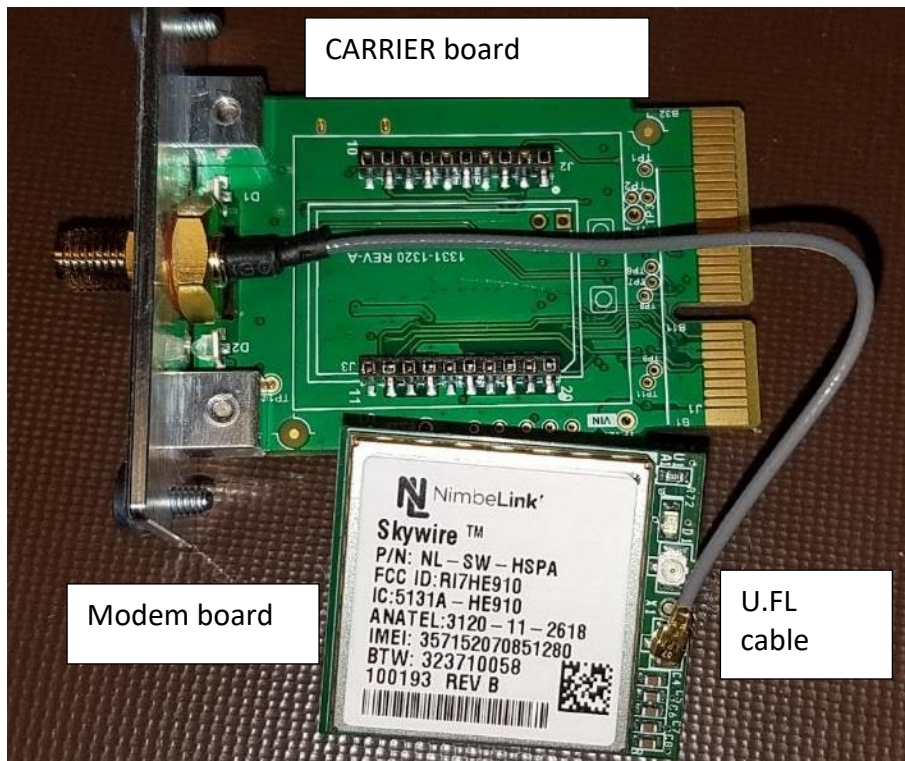

- 3.2. Flip the modem board carefully, without much stress on the U.FL cable; Insert the micro-sized sim card, and push it all the way into the sim card slot as shown in pictures below

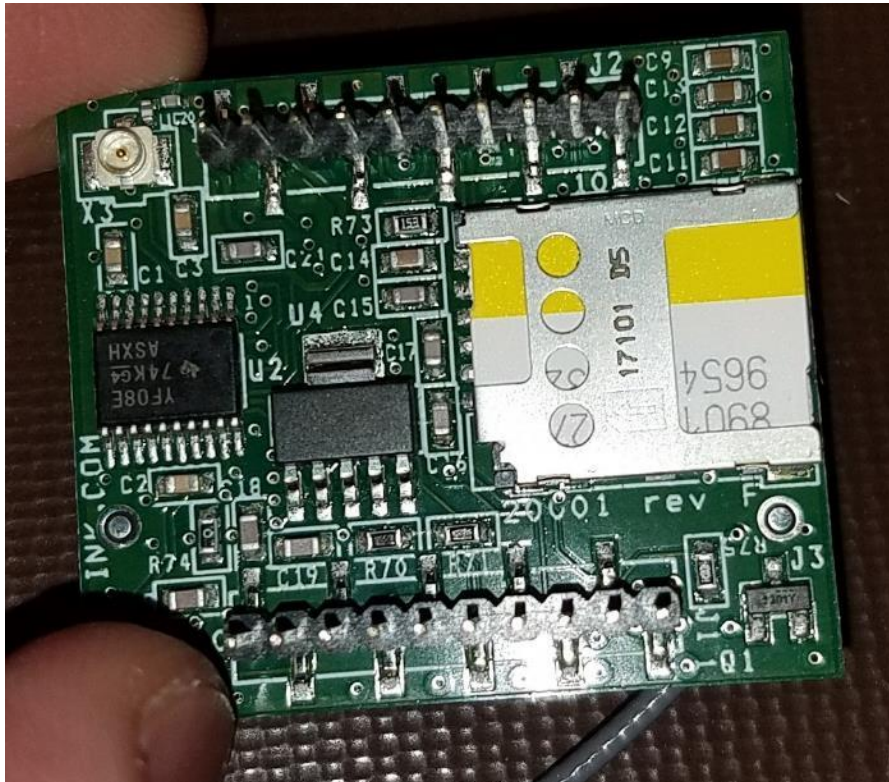

3.3. Flip the modem to correctly align the modem with respect to the carrier board. Make sure the U.FL cable is placed as shown in the pictures below.



- 3.4.** Aligning the pins on modem board, gently push the modem into the carrier board. A good alignment is shown in the pictures below

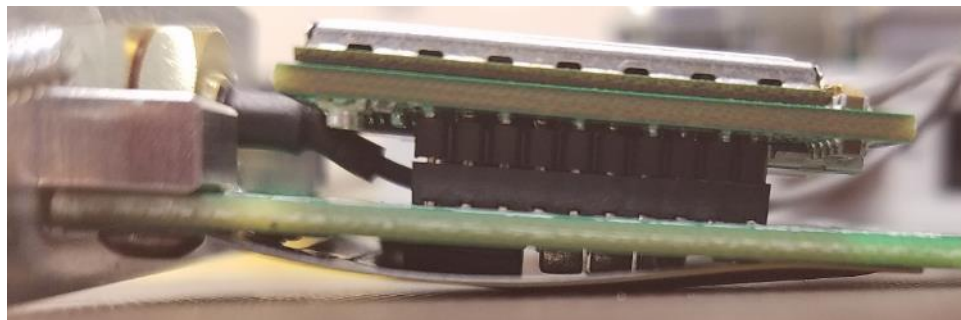

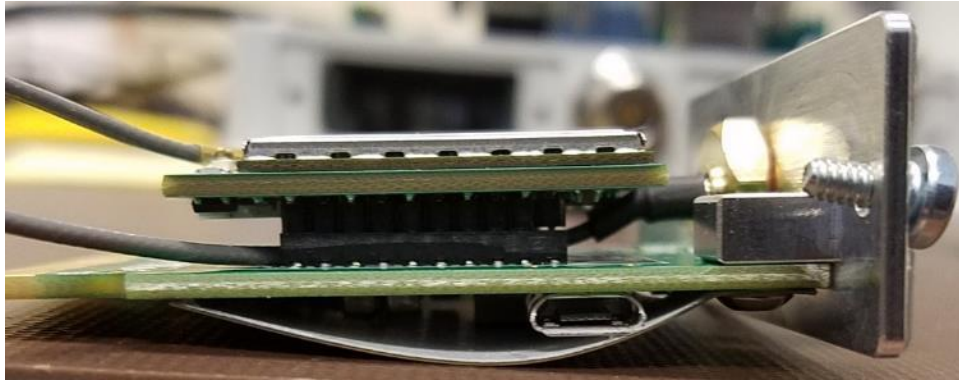

3.5. Use LinkComm “Cell Diags” to verify that the new SIM card is working correctly.



4. To remove the SIM card,
  - 4.1. remove power to station if cellular board is installed into the unit.
  - 4.2. Place the cellular board on a clean surface, and remove the modem board from the carrier board.
  - 4.3. Flip-over the modem board carefully without pulling the U.FL cable.
  - 4.4. Remove the SIM card carefully from the sim card slot
  - 4.5. If new sim card must be inserted, follow the instructions from sim card installation.

Carefully insert the modem board onto the carrier board, as shown in step [3.4](#).



# 26 Appendix G – Additional Safety, Installation, and Maintenance Instructions

The following section details safety, installation, and maintenance of the Sutron Xlink500/100 product family to ensure safety and reliability. This is valid for devices supplied by Sutron without housing, and for devices supplied by Sutron with NEMA enclosure.

## 26.1 Instructions for devices supplied without housing\*

### Safety Instructions and Warnings

- ▶ Please read the Operations & Maintenance Manual before using the Sutron XLINK 1 & XLINK 500/100 for the first time! Make yourself familiar with the installation and operation of the Sutron XLINK 1 & XLINK 500/100 and accessories! Keep the Operations & Maintenance Manual for later reference.
- ▶ Only install and maintain the Sutron XLINK 1 & XLINK 500/100 and the corresponding power supply if you are qualified and trained for this purpose!
- ▶ In addition, please observe all safety instructions and warnings given in the operating manuals of the rechargeable batteries and chargers as well as those printed on the device housings.
- ▶ Always observe the electrical and climatic limit values given in the specifications!
- ▶ Only use rechargeable batteries and chargers that are suitable and specified for the expected climatic conditions! Please note that temperatures up to 20 °C higher can occur inside a protective housing, which is exposed to direct sunlight!

**WARNING**



**Risk of fire and explosion if rechargeable batteries are handled improperly!**

- ▶ Avoid electrical short circuits!
- ▶ Avoid mechanical damages!
- ▶ Do not open rechargeable batteries!
- ▶ Do not throw rechargeable batteries into fire and/or expose them to high temperatures!
- ▶ Do not perform soldering work on rechargeable batteries!
- ▶ Protect rechargeable batteries from moisture!

**WARNING**



**Risk of burns due to accumulator acid!**

Rechargeable batteries contain highly corrosive acid. This acid can escape through degassing openings or if battery housing is damaged and cause severe burns to skin and eyes.

When handling rechargeable batteries:

- ▶ Wear eye protection!
- ▶ Wear protective gloves!
- ▶ Do not smoke!

\* for a detailed list of products, see end of section 26.1

### 26.1.1 Notes on installation

#### Installation location and choice of housing:

- ▶ **Install the rechargeable battery intended for power supply exclusively in a ventilated protective housing (switch cabinet)!**

When charging rechargeable batteries, certain amounts of hydrogen and oxygen gas (oxyhydrogen gas) escape -depending on the battery technology used. This gas mixture is extremely flammable and must be transported to the outside. Therefore, use for example commercially available ventilated housings. Alternatively, two diagonally opposed ventilation openings must be provided. The cross-section of these ventilation openings must be dimensioned appropriately. In addition, the openings need to be protected against water ingress and contamination (insects, ...), but at the same time they must guarantee an unobstructed air circulation.

- ▶ **It is recommended to use a solid state battery charger to be collocated with the battery.** The temp compensation will more accurately reflect the temperature of the battery and there is more physicalspace for the 3rd party regulator in the battery enclosure in most cases.

#### Ambient temperature:

- ▶ **For protective housings that are exposed to direct sunlight: Use enclosures with bare metal surface(stainless steel) or with white/light gray color.**
- ▶ **For installation locations with *continuously* high outside temperatures ( > approx. 30 °C):**
- ▶ **Provide effective shading for the housing containing the rechargeable battery, adapted to maximize sun shading during the course of the day.** This allows a temperature reduction of up to 10 °C inside the housing.

#### Electrical safety:

- ▶ **Use a safety fuse directly on the rechargeable battery to protect the Sutron XLINK 1 & XLINK 500/100 supply line.** This prevents a short circuit in case of improper handling or in case of malfunction. When selecting the fuse size, take into account the maximum current consumption of the Sutron XLINK 1 & XLINK 500/100 and all connected sensors and communication devices. Recommended tripping current:  $I_{max} \times 1.5$ ; tripping behavior medium slow blow fuse.
- ▶ **Only use a charger suitable for the battery technology and the expected ambient conditions.** Ideally, the charger should have temperature compensation of the charging voltage (e.g. a lead acid battery requires a temperature compensated solar regulator to appropriately decrease the voltage as the temperature increases). This reduces the escape of hydrogen and oxygen gas and extends the life of the rechargeable battery.
- ▶ **The battery technology dictates the charging requirements and should be followed closely.** E.g. wet cell (typ. automotive) batteries have a different charging voltage than a sealed lead acid battery.

## 26.1.2 Notes on Maintenance

### Check at regular intervals...

- ▶ ... the vent openings of the battery housing to ensure unhindered air circulation. Remove any contamination;
- ▶ ... the rechargeable battery for damage, deformation of the housing and any leaking battery acid;
- ▶ ... the connection terminals of the rechargeable battery for dirt and tightly connected leads;
- ▶ ... the battery voltage (fully charged, not loaded  $U_{\min} \geq 12 \text{ V}$ );

### Recommendation:

- ▶ Regularly check the remaining capacity of the rechargeable battery with an appropriate battery tester. Replace the rechargeable battery after 10 years of operation at the latest; earlier if the remaining capacity is low or in extreme climatic conditions.

### Section 26.1 applies to:

- |                   |                 |                  |
|-------------------|-----------------|------------------|
| ▶ XLink-1         | ▶ Xlink100-1    | ▶ Xlink100-IR-1  |
| ▶ IridiumLink-1   | ▶ Xlink500-1    | ▶ Xlink500-IR-1  |
| ▶ IridiumLink-1-D | ▶ Xlink100-C1-1 | ▶ Xlink100-IRD-1 |
| ▶ HSPALink-1      | ▶ Xlink500-C1-1 | ▶ Xlink500-IRD-1 |
| ▶ GPRSLink-1      | ▶ Xlink100-C5-1 |                  |
| ▶ CDMAlink-1      | ▶ Xlink500-C5-1 |                  |

## 26.2 Instructions for devices supplied with NEMA enclosure<sup>1,2</sup>

### Safety Instructions and Warnings

- ▶ Please read the Operations & Maintenance Manual before using the Sutron XLINK 1 & XLINK 500/100 for the first time! Make yourself familiar with the installation and operation of the Sutron XLINK 1 & XLINK 500/100 and accessories! Keep the Operations & Maintenance Manual for later reference.
- ▶ Only install and maintain the Sutron XLINK 1 & XLINK 500/100 and the corresponding power supply if you are qualified and trained for this purpose!
- ▶ In addition, please observe all safety instructions and warnings given in the operating manuals of the rechargeable batteries and chargers as well as those printed on the device housings.
- ▶ Always observe the electrical and climatic limit values given in the specifications!
- ▶ Only use rechargeable batteries and chargers that are suitable and specified for the expected climatic conditions! Please note that temperatures up to 20 °C higher can occur inside a protective housing, which is exposed to direct sunlight!

---

**WARNING**



**Risk of fire and explosion if rechargeable batteries are handled improperly!**

- ▶ Avoid electrical short circuits!
  - ▶ Avoid mechanical damages!
  - ▶ Do not open rechargeable batteries!
  - ▶ Do not throw rechargeable batteries into fire and/or expose them to high temperatures!
  - ▶ Do not perform soldering work on rechargeable batteries!
  - ▶ Protect rechargeable batteries from moisture!
- 

**WARNING**



**Risk of burns due to accumulator acid!**

Rechargeable batteries contain highly corrosive acid. This acid can escape through degassing openings or if battery housing is damaged and cause severe burns to skin and eyes.

When handling rechargeable batteries:

- ▶ Wear eye protection!
  - ▶ Wear protective gloves!
  - ▶ Do not smoke!
- 

1 For a detailed list of products, see end of section 26.2

2 These instructions only apply if the version of the NEMA enclosure supplied by Sutron DOES NOT have a vent

### 26.2.1 Notes on installation

#### **Ventilation of NEMA enclosure:**

- ▶ Retrofit the NEMA enclosure with an additional vent.
- ▶ When charging rechargeable batteries, certain amounts of hydrogen and oxygen gas (oxyhydrogen gas) escape, depending on the battery technology used. This gas mixture is extremely flammable and must be transported to the outside. Therefore, the NEMA enclosure must be retrofitted with the delivered venting device:
  1. Remove the top right dummy plug including the counter nut<sup>1)</sup> (or any other if this inlet is already in use);  
<sup>1)</sup> wrench size: 22 (metric).
  2. Install vent, washer and counter nut<sup>2)</sup>; <sup>2)</sup> wrench size: 18 (metric). Tighten the counter nut carefully; tightening torque max. 1.5 N m! Please note: there is an O-ring on the thread of the vent; don't remove.

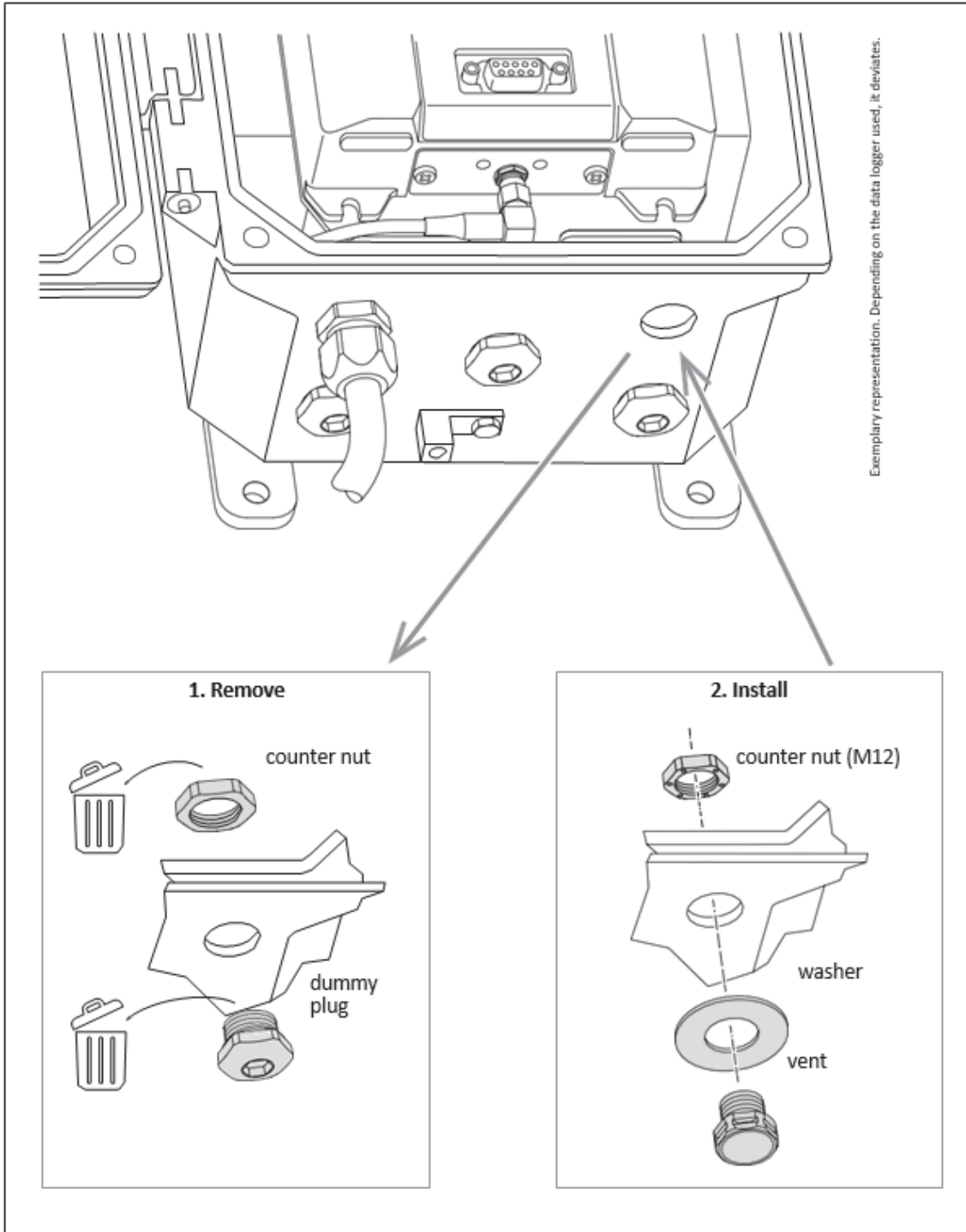

**Ambient temperature:**

- ▶ **For installation locations with *continuously* high outside temperatures ( > approx. 30 °C):**
- ▶ **Provide effective shading for the housing containing the rechargeable battery, adapted to maximize sun shading during the course of the day.** This allows a temperature reduction of up to 10 °C inside the housing.

### 26.2.2 Notes on maintenance

**Check at regular intervals...**

- ▶ ... the vent openings of the battery housing to ensure unhindered air circulation. Remove any contamination;
- ▶ ... the rechargeable battery for damage, deformation of the housing and any leaking battery acid;
- ▶ ... the connection terminals of the rechargeable battery for dirt and tightly connected leads;
- ▶ ... the battery voltage (fully charged, not loaded  $U_{min} \geq 12$  V);

**Recommendation:**

- ▶ Regularly check the remaining capacity of the rechargeable battery with an appropriate battery tester. Replace the rechargeable battery after 10 years of operation at the latest; earlier if the remaining capacity is low or in extreme climatic conditions.

**Section 26.1 applies to:**

- |                    |               |                  |                   |
|--------------------|---------------|------------------|-------------------|
| ▶ XLink-1E         | ▶ GPRSLink-1E | ▶ XLink100-1E    | ▶ XLink100-IR-1C  |
| ▶ IridiumLink-1E   | ▶ GPRSLink-1C | ▶ Xlink500-1E    | ▶ XLink100-IR-1E  |
| ▶ IridiumLink-1C   | ▶ GPRSLink-1L | ▶ Xlink100-C1-1C | ▶ XLink500-IR-1C  |
| ▶ IridiumLink-1L   | ▶ GPRSLink-1E | ▶ Xlink100-C1-1E | ▶ XLink500-IR-1E  |
| ▶ IridiumLink-1E-D | ▶ HSPALink-1E | ▶ Xlink500-C5-1C | ▶ XLink100-IRD-1C |
| ▶ IridiumLink-1C-D | ▶ HSPALink-1C | ▶ Xlink500-C5-1E | ▶ XLink100-IRD-1E |
| ▶ IridiumLink-1L-D | ▶ HSPALink-1L |                  | ▶ XLink500-IRD-1C |
|                    | ▶ CDMAlink-1E |                  | ▶ Xlink500-IRD-1E |
|                    | ▶ CDMAlink-1C |                  |                   |
|                    | ▶ CDMAlink-1L |                  |                   |